

SIOV metal oxide varistors

Leaded varistors, AdvanceD-MP, S10 series

Series/Type: B722*
Date: May 2017

© EPCOS AG 2017. Reproduction, publication and dissemination of this publication, enclosures hereto and the information contained therein without EPCOS' prior express consent is prohibited.

EPCOS AG is a TDK Group Company.

Construction

- Round varistor element, leaded
- Coating: epoxy resin, flame-retardant to UL 94 V-0

Features

- Wide operating voltage range 175 ... 680 V_{RMS}
- All types duty cycle @ 6 kV/ 3 kA = >10 pulses, according to IEC 60950-1, Annex Q; IEC 61051-2
- All types duty cycle @ 6 kV/ 3 kA = >15 pulses, according to UL 1449, 3rd edition, hybrid generator (1.2/ 50 μs: 8/20 μs), type 3 listed
- Multiple pulse handling capability

Approvals

- UL
- CSA
- VDE
- IEC

Delivery mode

- Bulk (standard), taped versions on reel or in Ammo pack upon request.
- For further details refer chapter "Taping, packaging and lead configuration" for leaded varistors.

General technical data

Climatic category	to IEC 60068-1	40/105/56	
Operating temperature	to IEC 61051	-40 ... +105	°C
Storage temperature		-40 ... +125	°C
Electric strength	to IEC 61051	≥ 2.5	kV _{RMS}
Insulation resistance	to IEC 61051	≥ 100	MΩ
Response time		< 25	ns

Electrical specifications and ordering codes
Maximum ratings ($T_A = 105\text{ °C}$)

Ordering code	Type (untaped) SIOV-	V_{RMS} V	V_{DC} V	i_{max} (8/20 μ s) A	W_{max} (2 ms) J	P_{max} W
B72210P2171K101	S10K175E2K1	175	225	3500	40.0	0.40
B72210P2271K101	S10K275E2K1	275	350	3500	60.0	0.40
B72210P2301K101	S10K300E2K1	300	385	3500	65.0	0.40
B72210P2321K101	S10K320E2K1	320	420	3500	72.0	0.40
B72210P2351K101	S10K350E2K1	350	460	3500	77.0	0.40
B72210P2381K101	S10K385E2K1	385	505	3500	82.0	0.40
B72210P2421K101	S10K420E2K1	420	560	3500	87.0	0.40
B72210P2461K101	S10K460E2K1	460	615	3500	92.0	0.40
B72210P2511K101	S10K510E2K1	510	670	3500	92.0	0.40
B72210P2551K101	S10K550E2K1	550	745	3500	97.0	0.40
B72210P2621K101	S10K620E2K1	625	825	3500	105.0	0.40
B72210P2681K101	S10K680E2K1	680	895	3500	115.0	0.40

Characteristics ($T_A = 25\text{ °C}$)

Ordering code	Type (untaped) SIOV-	V_v (1 mA) V	ΔV_v (1 mA) %	$V_{c,max}$ (i_c) V	i_c A	C_{typ} (1 kHz) pF
B72210P2171K101	S10K175E2K1	270	± 10	455	25.0	500
B72210P2271K101	S10K275E2K1	430	± 10	710	25.0	315
B72210P2301K101	S10K300E2K1	470	± 10	775	25.0	285
B72210P2321K101	S10K320E2K1	510	± 10	840	25.0	265
B72210P2351K101	S10K350E2K1	560	± 10	910	25.0	240
B72210P2381K101	S10K385E2K1	620	± 10	1025	25.0	230
B72210P2421K101	S10K420E2K1	680	± 10	1120	25.0	210
B72210P2461K101	S10K460E2K1	750	± 10	1240	25.0	190
B72210P2511K101	S10K510E2K1	820	± 10	1355	25.0	180
B72210P2551K101	S10K550E2K1	910	± 10	1500	25.0	160
B72210P2621K101	S10K620E2K1	1000	± 10	1650	25.0	150
B72210P2681K101	S10K680E2K1	1100	± 10	1815	25.0	135

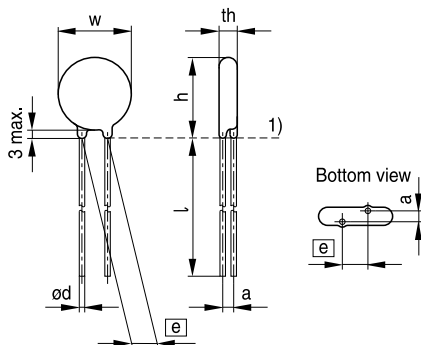
Dimensional drawings

1) Seating plane to IEC 60717

VAR0408-C-E

Weight

Nominal diameter mm	V_{RMS} V	Weight g
10	175 ... 680	1.7 ... 3.5

The weight of varistors in between these voltage classes can be interpolated.

Dimensions

Ordering code	[e] ±1 mm	a ±1 mm	w_{max} mm	th_{max} mm	h_{max} mm	l_{min} mm	d ±0.05 mm
B72210P2171K101	7.5	2.4	12.0	5.1	16.0	25.0	0.8
B72210P2271K101	7.5	3.2	12.0	5.9	16.0	25.0	0.8
B72210P2301K101	7.5	3.5	12.0	6.1	16.0	25.0	0.8
B72210P2321K101	7.5	3.7	12.0	6.3	16.0	25.0	0.8
B72210P2351K101	7.5	4.0	12.5	6.7	16.5	25.0	0.8
B72210P2381K101	7.5	4.3	12.5	7.7	16.5	25.0	0.8
B72210P2421K101	7.5	4.6	12.5	8.1	16.5	25.0	0.8
B72210P2461K101	7.5	5.0	12.5	8.4	16.5	25.0	0.8
B72210P2511K101	7.5	5.3	13.0	8.8	17.0	25.0	0.8
B72210P2551K101	7.5	5.8	13.0	9.3	17.0	25.0	0.8
B72210P2621K101	7.5	6.3	13.0	9.8	17.0	25.0	0.8
B72210P2681K101	7.5	6.9	13.0	10.4	17.0	25.0	0.8

Reliability data

Test	Test methods/conditions	Requirement
Varistor voltage	The voltage between two terminals with the specified measuring current applied is called V_V (1 mA _{DC} @ 0.2 ... 2 s).	To meet the specified value
Clamping voltage	The maximum voltage between two terminals with the specified standard impulse current (8/20 μ s) applied.	To meet the specified value
Endurance at upper category temperature	1000 h at UCT After having continuously applied the maximum allowable AC voltage at UCT ± 2 °C for 1000 h, the specimen shall be stored at room temperature and normal humidity for 1 to 2 h. Thereafter, the change of V_V shall be measured.	$ \Delta V/V$ (1 mA) $\leq 10\%$
Surge current derating, 8/20 μ s	10 surge currents (8/20 μ s), unipolar, interval 30 s, amplitude corresponding to derating curve for 10 impulses at 20 μ s	$ \Delta V/V$ (1 mA) $\leq 10\%$ (measured in direction of surge current) No visible damage
Surge current derating, 2 ms	10 surge currents (2 ms), unipolar, interval 120 s, amplitude corresponding to derating curve for 10 impulses at 2 ms	$ \Delta V/V$ (1 mA) $\leq 10\%$ (measured in direction of surge current) No visible damage
Electric strength	IEC 61051-1, test 4.9.2 Metal balls method, 2500 V _{RMS} , 60 s The varistor is placed in a container holding 1.6 \pm 0.2 mm diameter metal balls such that only the terminations of the varistor are protruding. The specified voltage shall be applied between both terminals of the specimen connected together and the electrode inserted between the metal balls.	No breakdown



Test	Test methods/conditions	Requirement
Climatic sequence	<p>The specimen shall be subjected to:</p> <p>a) dry heat at UCT, 16 h, IEC 60068-2-2, test Ba</p> <p>b) damp heat, 1st cycle: 55 °C, 93% r. H., 24 h, IEC 60068-2-30, test Db</p> <p>c) cold, LCT, 2 h, IEC 60068-2-1, test Aa</p> <p>d) damp heat, additional 5 cycles: 55 °C/25 °C, 93% r. H., 24 h/cycle, IEC 60068-2-30, test Db.</p> <p>Then the specimen shall be stored at room temperature and normal humidity for 1 to 2 h.</p> <p>Thereafter, the change of V_V shall be measured. Thereafter, insulation resistance R_{ins} shall be measured at $V = 500$ V.</p>	$ \Delta V/V (1 \text{ mA}) \leq 10\%$ $R_{ins} \geq 100 \text{ M}\Omega$
Rapid change of temperature	IEC 60068-2-14, test Na, LCT/UCT, dwell time 30 min, 5 cycles	$ \Delta V/V (1 \text{ mA}) \leq 5\%$ No visible damage
Damp heat, steady state	IEC 60068-2-78, test Ca The specimen shall be subjected to 40 ± 2 °C, 90 to 95% r. H. for 56 days without load / with 10% of the maximum continuous DC operating voltage V_{DC} . Then stored at room temperature and normal humidity for 1 to 2 h. Thereafter, the change of V_V shall be measured. Thereafter, insulation resistance R_{ins} shall be measured at $V = 500$ V (insulated varistors only).	$ \Delta V/V (1 \text{ mA}) \leq 10\%$ $R_{ins} \geq 100 \text{ M}\Omega$



Test	Test methods/conditions	Requirement
Solderability	<p>IEC 60068-2-20, test Ta, method 1 with modified conditions for lead-free solder alloys: 245 °C, 3 s:</p> <p>After dipping the terminals to a depth of approximately 3 mm from the body in a soldering bath of 245 °C for 3 s, the terminals shall be visually examined.</p>	<p>The inspection shall be carried out under adequate light with normal eyesight or with the assistance of a magnifier capable of giving a magnification of 4 to 10 times. The dipped surface shall be covered with a smooth and bright solder coating with no more than small amounts of scattered imperfections such as pinholes or un-wetted or de-wetted areas. These imperfections shall not be concentrated in one area.</p>
Resistance to soldering heat	<p>IEC 60068-2-20, test Tb, method 1A, 260 °C, 10 s:</p> <p>Each lead shall be dipped into a solder bath having a temperature of 260 ±5 °C to a point 2.0 to 2.5 mm from the body of the specimen, be held there for 10 ±1 s and then be stored at room temperature and normal humidity for 1 to 2 h.</p> <p>The change of V_V shall be measured and the specimen shall be visually examined.</p>	<p>$\Delta V/V (1 \text{ mA}) \leq 5\%$</p> <p>No visible damage</p>
Tensile strength	<p>IEC 60068-2-21, test Ua1</p> <p>After gradually applying the force specified below and keeping the unit fixed for 10 s, the terminal shall be visually examined for any damage.</p> <p>Force for wire diameter:</p> <p>0.6 mm = 10 N 0.8 mm = 10 N 1.0 mm = 20 N</p>	<p>$\Delta V/V (1 \text{ mA}) \leq 5\%$</p> <p>No break of solder joint, no wire break</p>

Leaded varistors
B722*
AdvanceD-MP, S10 series

Test	Test methods/conditions	Requirement
Vibration	IEC 60068-2-6, test Fc, method B4 Frequency range: 10 ... 55 Hz Amplitude: 0.75 mm or 98 m/s ² Duration: 6 h (3 · 2 h) Pulse: sine wave After repeatedly applying a single harmonic vibration according to the table above. The change of V_v shall be measured and the specimen shall be visually examined.	$ \Delta V/V (1 \text{ mA}) \leq 5\%$ No visible damage
Bump	IEC 60068-2-29, test Eb Pulse duration: 6 ms Max. acceleration: 400 m/s ² Number of bumps: 4000 Pulse: half sine	$ \Delta V/V (1 \text{ mA}) \leq 5\%$ No visible damage
Fire hazard	IEC 60695-11-5 (needle flame test) Severity: vertical 10 s	5 s max.

Note:

UCT = Upper category temperature

LCT = Lower category temperature

 R_{ins} = Insulation resistance



v/i characteristics

$v = f(i)$ - for explanation of the characteristics refer to "General technical information", 1.6.3
 A = Leakage current, B = Protection level } for worst-case varistor tolerances

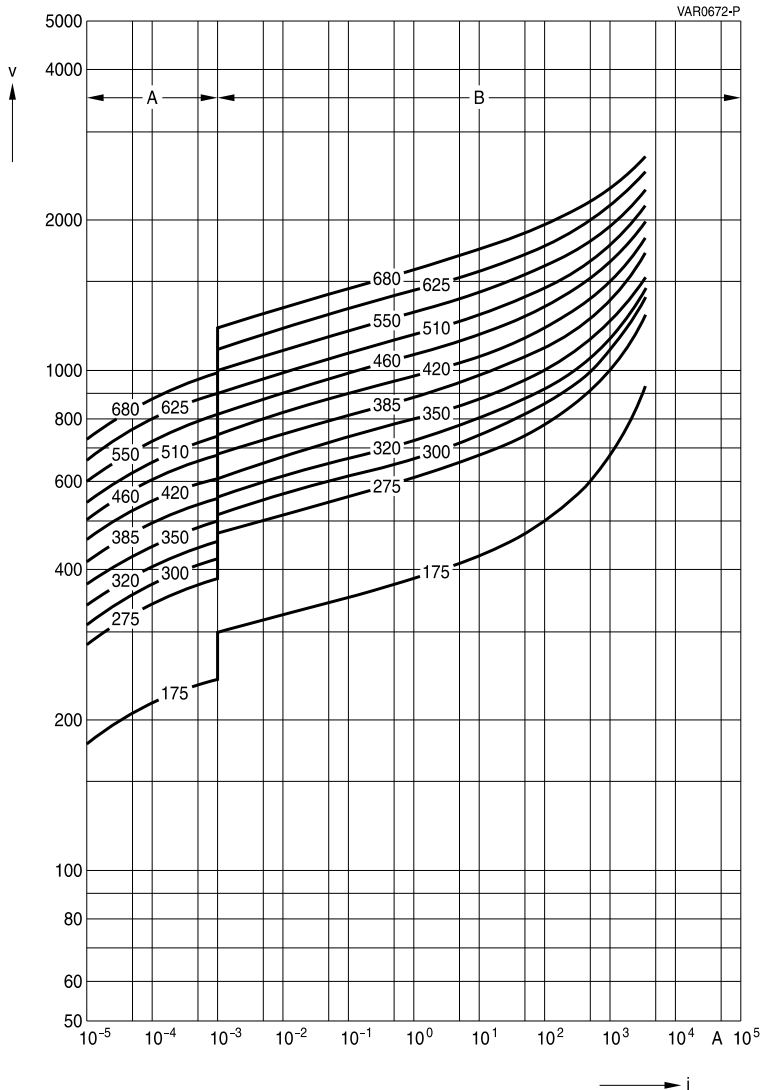

SIOV-S10 ... E2K1



Derating curves

Maximum surge current $i_{max} = f(t_r, \text{pulse train})$

For explanation of the derating curves refer to "General technical information", section 1.8.1

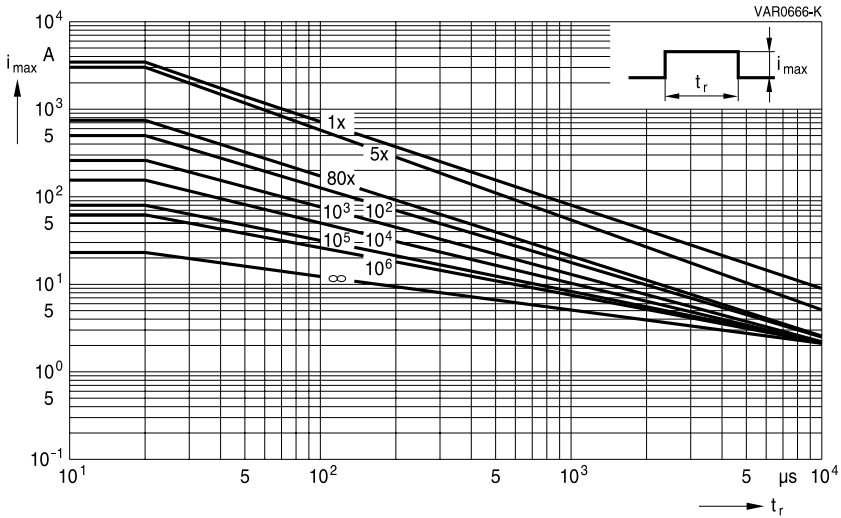

SIOV-S10K175 ... K460E2K1

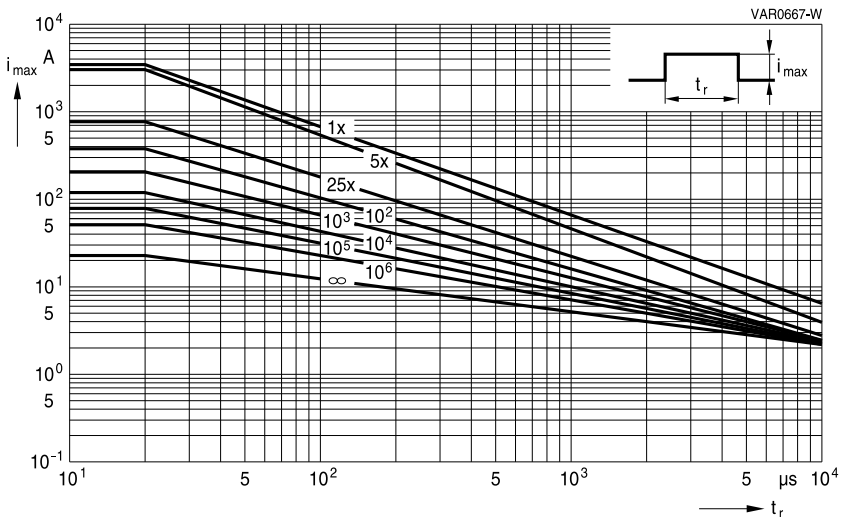

SIOV-S10K510 ... K680E2K1



Leaded varistors

B722*

AdvanceD-MP, S10 series

Taping, packaging and lead configuration

1 EPCOS ordering code system

For leaded varistors

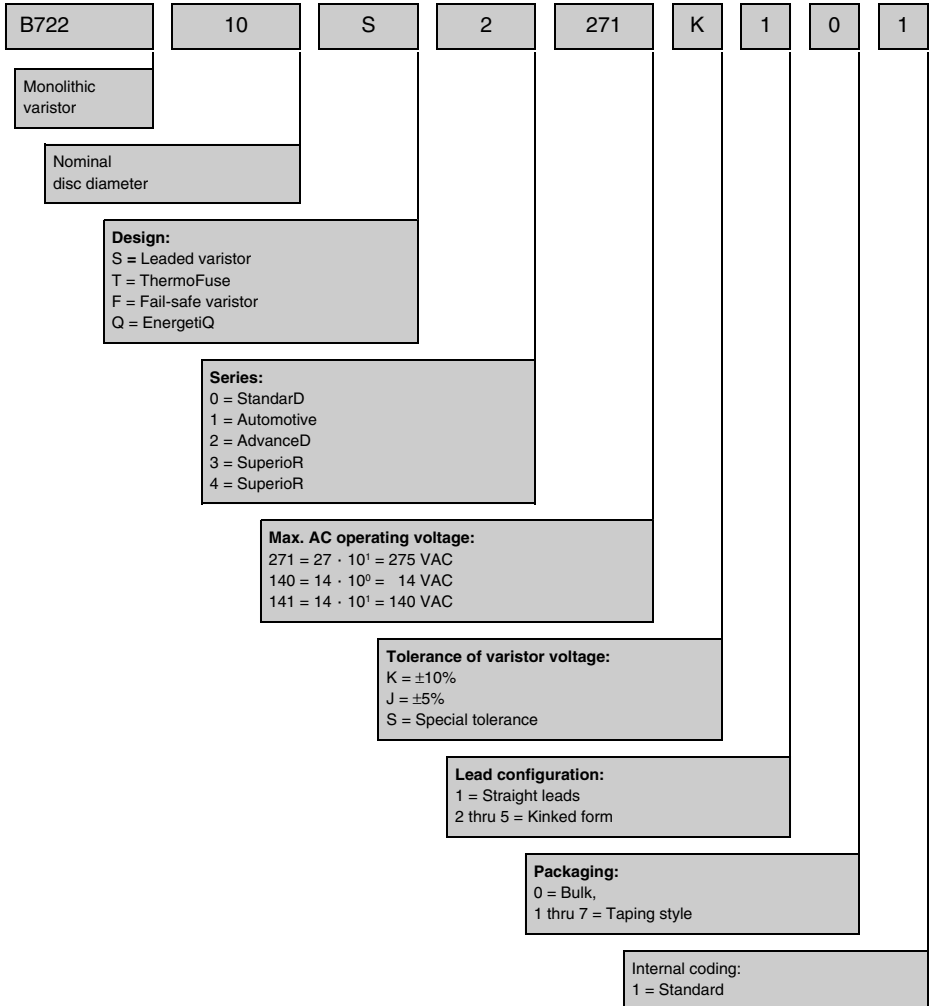



Leaded varistors

B722*

AdvanceD-MP, S10 series

2 Taping and packaging of leaded varistors

Tape packaging for lead spacing $[e] = 5$ fully conforms to IEC 60286-2, while for lead spacings $[e] = 7.5$ and 10 the taping mode is based on this standard.

2.1 Taping in accordance with IEC 60286-2 for lead spacing 5.0 mm

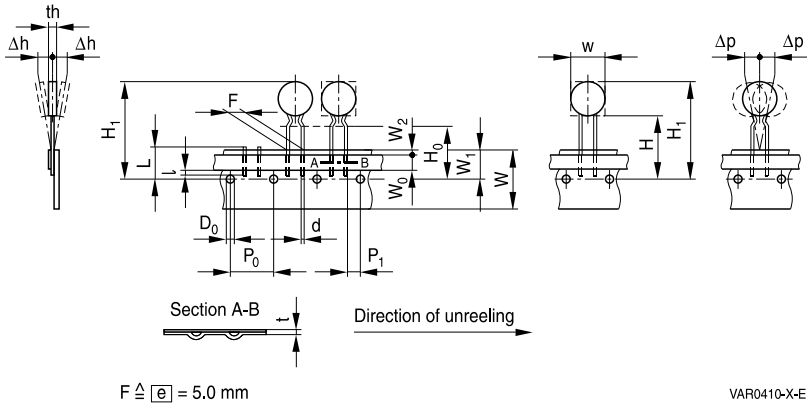

2.2 Taping based on IEC 60286-2 for lead spacing 7.5 and 10 mm

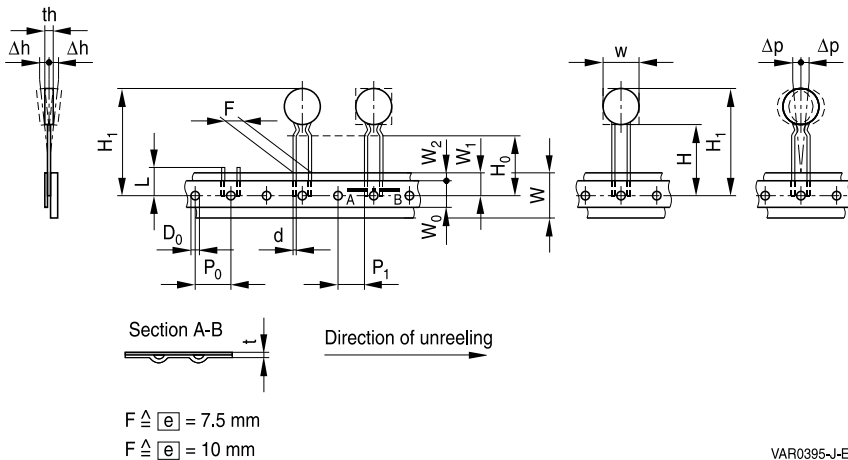



2.3 Tape dimensions (in mm)

Symbol	$e = 5.0$	Tolerance	$e = 7.5$	Tolerance	$e = 10.0$	Tolerance	Remarks	
w		max.		max.		max.	see tables in each series under "Dimensions"	
th		max.		max.		max.		
d	0.6	± 0.05	0.8	± 0.05	1.0	± 0.05		
P ₀	12.7	± 0.3	12.7 ¹⁾	± 0.3	12.7	± 0.3	± 1 mm/20 sprocket holes	
P ₁	3.85	± 0.7	8.95	± 0.8	7.7	± 0.8		
F	5.0	$+0.6/-0.1$	7.5	± 0.8	10.0	± 0.8	measured at top of component body	
Δh	0	± 2.0	depends on s		depends on s			
Δp	0	± 1.3	0	± 2.0	0	± 2.0		
W	18.0	± 0.5	18.0	± 0.5	18.0	± 0.5	Peel-off force ≥ 5 N	
W ₀	5.5	min.	11.0	min.	11.0	min.		
W ₁	9.0	± 0.5	9.0	$+0.75/-0.5$	9.0	$+0.75/-0.5$		
W ₂	3.0	max.	3.0	max.	3.0	max.		
H	18.0	$+2.0/-0$	18.0	$+2.0/-0$	18.0	$+2.0/-0$	²⁾	
H ₀	16.0 (18.0)	± 0.5	16.0 (18.0)	± 0.5	16.0	± 0.5		³⁾
H ₁	32.2	max.	45.0	max.	45.0	max.		
D ₀	4.0	± 0.2	4.0	± 0.2	4.0	± 0.2	without lead	
t	0.9	max.	0.9	max.	0.9	max.		
L	11.0	max.	11.0	max.	11.0	max.		
l	4.0	max.						

1) Taping with P₀ = 15.0 mm upon request

2) Applies only to uncrimped types

3) Applies only to crimped types (H₀ = 18 upon request)



2.4 Taping mode

Example: B72210S0271K1 5 1
|
Digit 14

Digit 14	Taping mode	Reel type	Seating plane height H ₀ for crimped types mm	Seating plane height H for uncrimped types mm	Pitch distance P ₀ mm
0	–	Bulk	–	–	–
1	G	I	16	18	12.7
2	G2	I	18	–	12.7
3	G3	II	16	18	12.7
4	G4	II	18	–	12.7
5	G5	III	16	18	12.7
6	GA	Ammo pack	16	18	12.7
7	G2A	Ammo pack	18	–	12.7
Internal coding for special taping					
	G6	III	18	–	12.7
	G10	II	16	18	15.0
	G11	II	18	–	15.0
	G10A	Ammo pack	16	18	15.0
	G11A	Ammo pack	18	–	15.0



2.5 Reel dimension

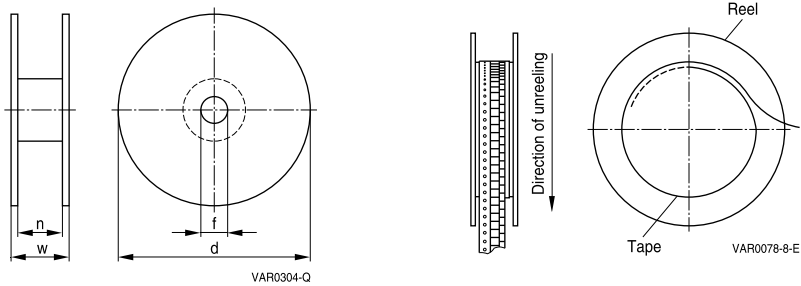

Dimensions (in mm)

Reel type	d	f	n	w
I	360 max.	31 ±1	approx. 45	54 max.
II	360 max.	31 ±1	approx. 55	64 max.
III	500 max.	23 ±1	approx. 59	72 max.

If reel type III is not compatible with insertion equipment because of its large diameter, nominal disk diameter 10 mm and 14 mm can be supplied on reel II upon request (taping mode G3).

2.6 Ammo pack dimensions

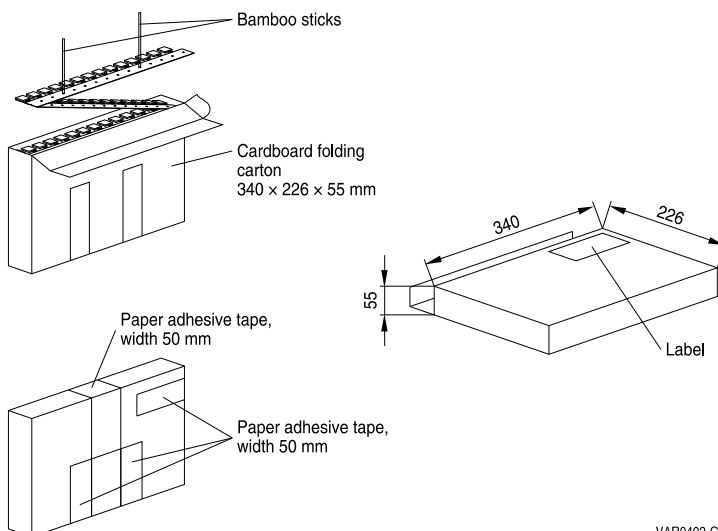

VAR0402-G



3 Lead configuration

Straight leads are standard for disk varistors. Other lead configurations as crimp style or customer-specific lead wire length according to 3.1, 3.2, 3.3 and 3.4 are optional. Crimped leads (non-standard) are differently crimped for technical reasons; the individual crimp styles are denoted by consecutive numbers (S, S2 through S5) as shown in the dimensional drawings below.

The crimp styles of the individual types can be seen from the type designation in the ordering tables.

3.1 Crimp style mode

Example: B72210S0271K **5** 01

Digit 13

Digit 13 of ordering code	Crimp style	Figure
1	Standard, straight leads	1
2	S2	2
3	S3	3
4	S4	4
5	S5	5
Available upon request		
Internal coding	—	6

3.2 Standard leads and non-standard crimp styles

Standard, straight leads

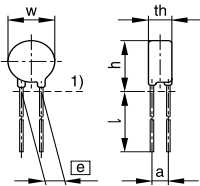

1) Seating plane to IEC 717
VAR0586-W-E

Figure 1

Non-standard, crimp style S2

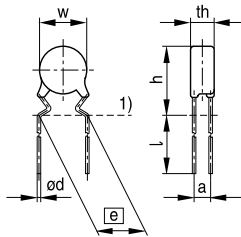

1) Seating plane to IEC 60717
VAR0411-F-E

Figure 2

Non-standard, crimp style S3

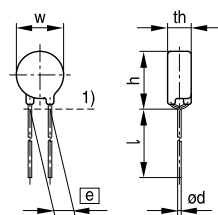

1) Seating plane to IEC 60717
VAR0396-R-E

Figure 3

Non-standard, crimp style S4

1) Seating plane to IEC 60717

VAR0404-W-E

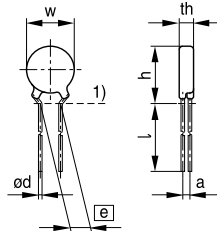
Non-standard, crimp style S5

1) Seating plane to IEC 60717

VAR0412-N-E

Figure 4
Figure 5

3.3 Component height (h_{max}) for crimped versions (non-standard)

Due to technical reasons the component height (h_{max}) increases if a crimp is added. The maximum height of the crimped component can be found in the table below.

Nominal diameter mm	V_{RMS} V	Crimp style	e mm	h_{max} mm
5	11 ... 175	S2	5.0	10.0
5	210 ... 460	S3	5.0	10.0
7	11 ... 175	S2	5.0	12.0
7	210 ... 460	S3	5.0	12.0
10	11 ... 300	S5	7.5	15.5
10	320 ... 460	S3/S5	7.5	16.5
10	510	S3/S5	7.5	17.5
10	Automotive	S5	7.5	17.0
10	Automotive (D1 types)	S5	7.5	16.0
10	11 ... 175	S4	5.0	16.5
10	210 ... 460	S3	5.0	16.5
14	11 ... 300	S5	7.5	20.0
14	320 ... 460	S3/S5	7.5	20.0
14	510	S3/S5	7.5	21.5
14	Automotive	S5	7.5	21.0
14	Automotive (D1 types)	S5	7.5	20.0
20	11 ... 320	S5	10.0	27.0
20	385 ... 510	S5	10.0	27.5



3.4 Trimmed leads (non-standard)

Varistors with cut leads available upon request.

Lead length tolerances:

Straight leads ± 1.0 mm

Crimped leads ± 0.8 mm

Minimum lead length 3.5 mm

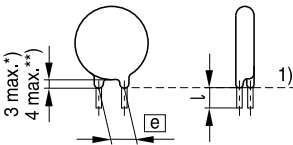

1) Seating plane to IEC 60717

*) For round component head

**) For EnergetiQ series, square component head

VAR0642-U-E

Figure 6



Cautions and warnings

General

1. EPCOS metal oxide varistors are designed for specific applications and should not be used for purposes not identified in our specifications, application notes and data books unless otherwise agreed with EPCOS during the design-in-phase.
2. Ensure suitability of SIOVs through reliability testing during the design-in phase. SIOVs should be evaluated taking into consideration worst-case conditions.
3. For applications of SIOVs in line-to-ground circuits based on various international and local standards there are restrictions existing or additional safety measures required.

Storage

1. Store SIOVs only in original packaging. Do not open the package prior to processing.
2. Storage conditions in original packaging:
 Storage temperature: $-25\text{ }^{\circ}\text{C} \dots +45\text{ }^{\circ}\text{C}$,
 Relative humidity: $<75\%$ annual average,
 $<95\%$ on maximum 30 days a year.
 Dew precipitation: is to be avoided.
3. Avoid contamination of an SIOV's during storage, handling and processing.
4. Avoid storage of SIOVs in harmful environments that can affect the function during long-term operation (examples given under operation precautions).
5. The SIOV type series should be soldered within the time specified:

SIOV-S, -Q, -LS, -B, -SFS	24 months
ETFV and T series	12 months.

Handling

1. SIOVs must not be dropped.
2. Components must not be touched with bare hands. Gloves are recommended.
3. Avoid contamination of the surface of SIOV electrodes during handling, be careful of the sharp edge of SIOV electrodes.

Soldering (where applicable)

1. Use rosin-type flux or non-activated flux.
2. Insufficient preheating may cause ceramic cracks.
3. Rapid cooling by dipping in solvent is not recommended.
4. Complete removal of flux is recommended.
5. Temperatures of all preheat stages and the solder bath must be strictly controlled especially for T series (T14 and T20).



Mounting

1. Potting, sealing or adhesive compounds can produce chemical reactions in the SIOV ceramic that will degrade the component's electrical characteristics.
2. Overloading SIOVs may result in ruptured packages and expulsion of hot materials. For this reason SIOVs should be physically shielded from adjacent components.

Operation

1. Use SIOVs only within the specified temperature operating range.
2. Use SIOVs only within the specified voltage and current ranges.
3. Environmental conditions must not harm SIOVs. Use SIOVs only in normal atmospheric conditions. Avoid use in deoxidizing gases (chlorine gas, hydrogen sulfide gas, ammonia gas, sulfuric acid gas etc), corrosive agents, humid or salty conditions. Contact with any liquids and solvents should be prevented.

Display of ordering codes for EPCOS products

The ordering code for one and the same EPCOS product can be represented differently in data sheets, data books, other publications, on the EPCOS website, or in order-related documents such as shipping notes, order confirmations and product labels. **The varying representations of the ordering codes are due to different processes employed and do not affect the specifications of the respective products.** Detailed information can be found on the Internet under www.epcos.com/orderingcodes

Symbols and terms

Symbol	Term
C	Capacitance
C_{typ}	Typical capacitance
i	Current
i_c	Current at which $V_{c, max}$ is measured
I_{leak}	Leakage current
i_{max}	Maximum surge current (also termed peak current)
I_{max}	Maximum discharge current
I_n	Nominal discharge current
LCT	Lower category temperature
L_{typ}	Typical inductance
P_{max}	Maximum average power dissipation
R_{ins}	Insulation resistance
R_{min}	Minimum resistance
T_A	Ambient temperature
t_r	Duration of equivalent rectangular wave
UCT	Upper category temperature
v	Voltage
V_{clamp}	Clamping voltage
$V_{c, max}$	Maximum clamping voltage at specified current i_c
V_{DC}	DC operating voltage
V_{jump}	Maximum jump start voltage
V_{max}	Maximum voltage
V_{op}	Operating voltage
V_{RMS}	AC operating voltage, root-mean-square value
$V_{RMS, op, max}$	Root-mean-square value of max. DC operating voltage incl. ripple current
V_{surge}	Super imposed surge voltage
V_V	Varistor voltage
ΔV_V	Tolerance of varistor voltage
W_{LD}	Maximum load dump
W_{max}	Maximum energy absorption
e	Lead spacing

All dimensions are given in mm.

The commas used in numerical values denote decimal points.

Important notes

The following applies to all products named in this publication:

1. Some parts of this publication contain **statements about the suitability of our products for certain areas of application**. These statements are based on our knowledge of typical requirements that are often placed on our products in the areas of application concerned. We nevertheless expressly point out **that such statements cannot be regarded as binding statements about the suitability of our products for a particular customer application**. As a rule we are either unfamiliar with individual customer applications or less familiar with them than the customers themselves. For these reasons, it is always ultimately incumbent on the customer to check and decide whether a product with the properties described in the product specification is suitable for use in a particular customer application.
2. We also point out that **in individual cases, a malfunction of electronic components or failure before the end of their usual service life cannot be completely ruled out in the current state of the art, even if they are operated as specified**. In customer applications requiring a very high level of operational safety and especially in customer applications in which the malfunction or failure of an electronic component could endanger human life or health (e.g. in accident prevention or life-saving systems), it must therefore be ensured by means of suitable design of the customer application or other action taken by the customer (e.g. installation of protective circuitry or redundancy) that no injury or damage is sustained by third parties in the event of malfunction or failure of an electronic component.
3. **The warnings, cautions and product-specific notes must be observed.**
4. In order to satisfy certain technical requirements, **some of the products described in this publication may contain substances subject to restrictions in certain jurisdictions (e.g. because they are classified as hazardous)**. Useful information on this will be found in our Material Data Sheets on the Internet (www.tdk-electronics.tdk.com/material). Should you have any more detailed questions, please contact our sales offices.
5. We constantly strive to improve our products. Consequently, **the products described in this publication may change from time to time**. The same is true of the corresponding product specifications. Please check therefore to what extent product descriptions and specifications contained in this publication are still applicable before or when you place an order.

We also **reserve the right to discontinue production and delivery of products**. Consequently, we cannot guarantee that all products named in this publication will always be available. The aforementioned does not apply in the case of individual agreements deviating from the foregoing for customer-specific products.
6. Unless otherwise agreed in individual contracts, **all orders are subject to our General Terms and Conditions of Supply**.
7. **Our manufacturing sites serving the automotive business apply the IATF 16949 standard**. The IATF certifications confirm our compliance with requirements regarding the quality management system in the automotive industry. Referring to customer requirements and customer specific requirements ("CSR") TDK always has and will continue to have the policy of respecting individual agreements. Even if IATF 16949 may appear to support the acceptance of unilateral requirements, we hereby like to emphasize that **only requirements mutually agreed upon can and will be implemented in our Quality Management System**. For clarification purposes we like to point out that obligations from IATF 16949 shall only become legally binding if individually agreed upon.

Important notes

8. The trade names EPCOS, CeraCharge, CeraDiode, CeraLink, CeraPad, CeraPlas, CSMP, CTVS, DeltaCap, DigiSiMic, ExoCore, FilterCap, FormFit, LeaXield, MiniBlue, MiniCell, MKD, MKK, MotorCap, PCC, PhaseCap, PhaseCube, PhaseMod, PhiCap, PowerHap, PQSine, PQvar, SIFERRIT, SIFI, SIKOREL, SilverCap, SIMDAD, SiMic, SIMID, SineFormer, SIOV, ThermoFuse, WindCap are **trademarks registered or pending** in Europe and in other countries. Further information will be found on the Internet at www.tdk-electronics.tdk.com/trademarks.

Release 2018-10