

## EMC Filters

**Series/Type:**      **B84142A\*S002**

The following products presented in this data sheet are being withdrawn.

Ordering Code	Substitute Product	Date of Withdrawal	Deadline Last Orders	Last Shipments
B84142A1000S018		2013-04-12	2013-07-31	2013-10-31
B84142A0500S018		2013-04-12	2013-07-31	2013-10-31
B84142A0250S018		2013-04-12	2013-07-31	2013-10-31

© EPCOS AG 2015. Reproduction, publication and dissemination of this publication, enclosures hereto and the information contained therein without EPCOS' prior express consent is prohibited.

EPCOS AG is a TDK Group Company.



Ordering Code	Substitute Product	Date of Withdrawal	Deadline Last Orders	Last Shipments
B84142A1000S003		2013-04-12	2013-07-31	2013-10-31
B84142A0500S003		2013-04-12	2013-07-31	2013-10-31
B84142A0250S003		2013-04-12	2013-07-31	2013-10-31
B84142A1000S002		2013-04-12	2013-07-31	2013-10-31
B84142A0500S002		2013-04-12	2013-07-31	2013-10-31
B84142A0250S002		2013-04-12	2013-07-31	2013-10-31

For further information please contact your nearest EPCOS sales office, which will also support you in selecting a suitable substitute. The addresses of our worldwide sales network are presented at [www.epcos.com/sales](http://www.epcos.com/sales).

**Power line filters for DC systems**  
**Rated voltage 750 to 2000 V DC**  
**Rated current 250 to 1000 A**

**Construction**

- 2-line filters
- Metal case

**Features**

- Easy to install
- Space-saving design
- Optimized for long motor cables and operation under full load
- Design based on EN 133 200, UL 1283, CSA C22.2 No.8

**Applications**

- Trams, light rails
- Subways

**Terminals**

- Busbars, tin-plated

**Marking**

Marking on component:  
 Manufacturer's logo, ordering code, rated voltage, rated current, rated temperature, climatic category, date code

Minimum marking on packaging:  
 Manufacturer's logo, ordering code

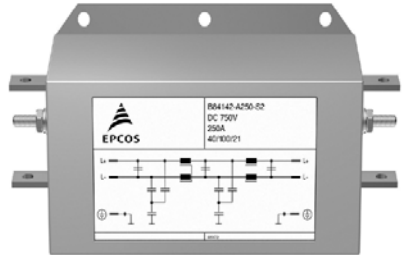

**Typical circuit diagram**

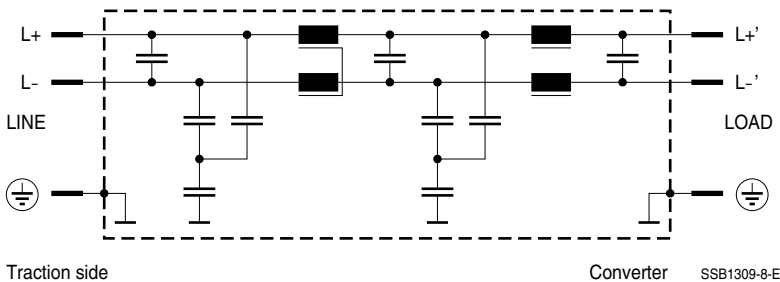

**Technical data and measuring conditions**

Rated voltage $V_R$	Type S002: 750 V DC Type S003: 1000 V DC Type S018: 2000 V DC
Rated current $I_R$	Referred to 60 °C ambient temperature
Test voltage $V_{\text{test}}$	Type S002: 2000 V DC, 60 s (L+/L-) 4900 V DC, 60 s (L+    L-/case) 6000 V DC, 2 s (L+    L-/case)
	Type S003: 2500 V DC, 60 s (L+/L-) 4900 V DC, 60 s (L+    L-/case) 6000 V DC, 2 s (L+    L-/case)
	Type S018: 4000 V DC, 60 s (L+/L-) 4900 V DC, 60 s (L+    L-/case) 6000 V DC, 2 s (L+    L-/case)
Overload capability (thermal)	1.6 · $I_R$ for 20 s per hour or 2.0 · $I_R$ for 10 s per hour
Climatic category (IEC 60068-1)	40/100/21 (-40 °C/+100 °C/21 days damp heat test)

**Characteristics and ordering codes**

$V_R$ DC V	$I_R$ A	$R_{\text{typ}}$ $\mu\Omega$	Approx. weight kg	Ordering code
750	250	63	12	B84142A0250S002
	500	57	13	B84142A0500S002
	1000	33	26	B84142A1000S002
1000	250	63	12	B84142A0250S003
	500	57	13	B84142A0500S003
	1000	33	26	B84142A1000S003
2000	250	63	12	B84142A0250S018
	500	57	13	B84142A0500S018
	1000	33	26	B84142A1000S018

Dimensional drawings

B84142A0250S0\*\* (250 A)

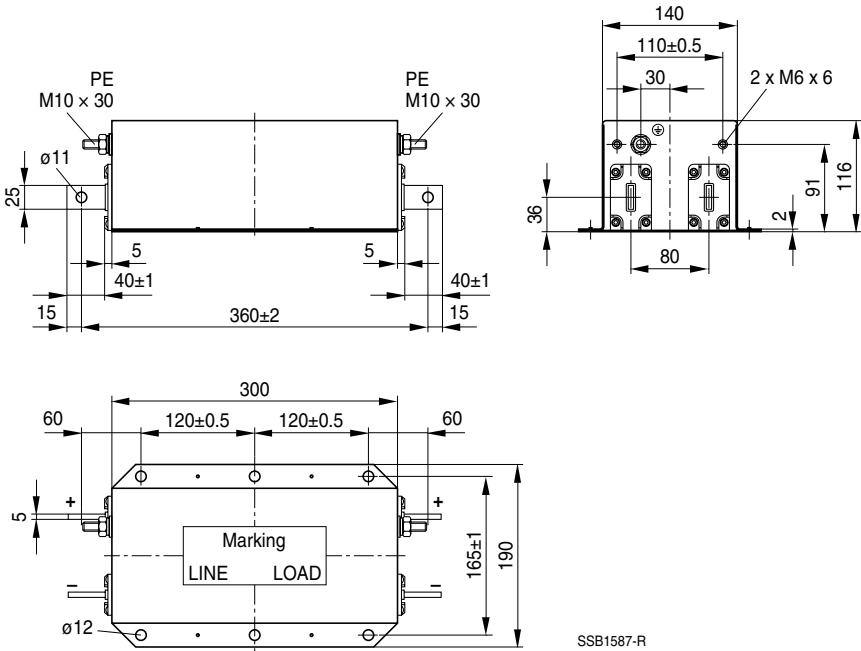

B84142A0500S0\*\* (500 A)

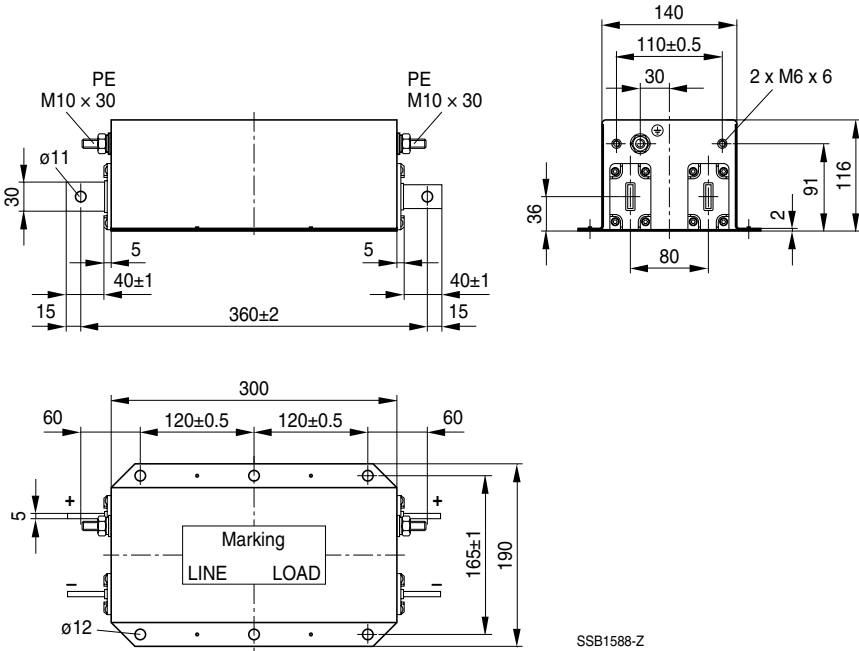

B84142A1000S0\*\* (1000 A)

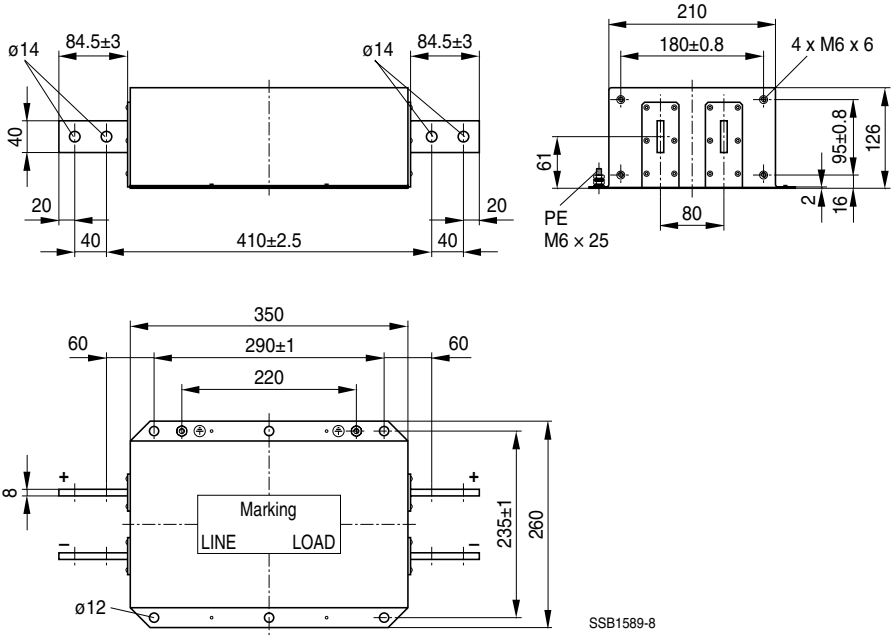

**Insertion loss** (typical values at  $Z = 50 \Omega$ )

- unsymmetrical, adjacent branches terminated
- common mode, all branches in parallel (asymmetrical)
- differential mode (symmetrical)

Filters for 250 and 500 A

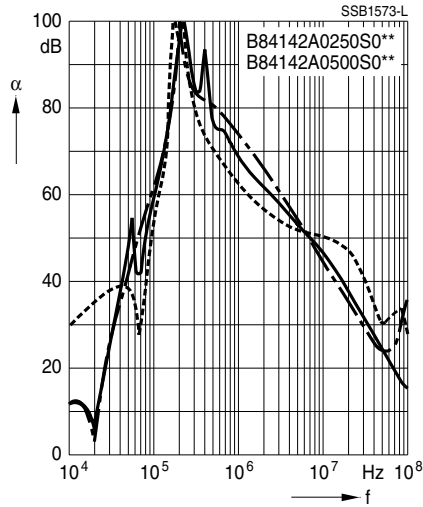

Filters for 1000 A

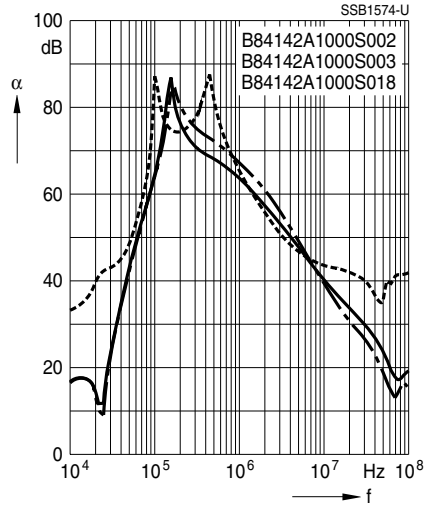



### Important information

Please read all safety and warning notes carefully before installing the EMC filter and putting it into operation (see ) . The same applies to the warning signs on the filter. Please ensure that the signs are not removed nor their legibility impaired by external influences.

Death, serious bodily injury and substantial material damage to equipment may occur if the appropriate safety measures are not carried out or the warnings in the text are not observed.

### Using according to the terms

The EMC filters may be used only for their intended application within the specified values in low-voltage networks in compliance with the instructions given in the data sheets and the data book. The conditions at the place of application must comply with all specifications for the filter used.

### Warnings

- It shall be ensured that only qualified persons (electricity specialists) are engaged on work such as planning, assembly, installation, operation, repair and maintenance. They must be provided with the corresponding documentation.
- Danger of electric shock. EMC filters contain components that store an electric charge. Dangerous voltages can continue to exist at the filter terminals for longer than five minutes even after the power has been switched off.
- The protective earth connections shall be the first to be made when the EMC filter is installed and the last to be disconnected. Depending on the magnitude of the leakage currents, the particular specifications for making the protective-earth connection must be observed.
- Impermissible overloading of the EMC filter, such as impermissible voltages at higher frequencies that may cause resonances etc. can lead to destruction of the filter housing.
- EMC filters must be protected in the application against impermissible exceeding of the rated currents by suitable overcurrent protective.

## Important notes

The following applies to all products named in this publication:

1. Some parts of this publication contain **statements about the suitability of our products for certain areas of application**. These statements are based on our knowledge of typical requirements that are often placed on our products in the areas of application concerned. We nevertheless expressly point out **that such statements cannot be regarded as binding statements about the suitability of our products for a particular customer application**. As a rule we are either unfamiliar with individual customer applications or less familiar with them than the customers themselves. For these reasons, it is always ultimately incumbent on the customer to check and decide whether a product with the properties described in the product specification is suitable for use in a particular customer application.
2. We also point out that **in individual cases, a malfunction of electronic components or failure before the end of their usual service life cannot be completely ruled out in the current state of the art, even if they are operated as specified**. In customer applications requiring a very high level of operational safety and especially in customer applications in which the malfunction or failure of an electronic component could endanger human life or health (e.g. in accident prevention or life-saving systems), it must therefore be ensured by means of suitable design of the customer application or other action taken by the customer (e.g. installation of protective circuitry or redundancy) that no injury or damage is sustained by third parties in the event of malfunction or failure of an electronic component.
3. **The warnings, cautions and product-specific notes must be observed.**
4. In order to satisfy certain technical requirements, **some of the products described in this publication may contain substances subject to restrictions in certain jurisdictions (e.g. because they are classed as hazardous)**. Useful information on this will be found in our Material Data Sheets on the Internet ([www.tdk-electronics.tdk.com/material](http://www.tdk-electronics.tdk.com/material)). Should you have any more detailed questions, please contact our sales offices.
5. We constantly strive to improve our products. Consequently, **the products described in this publication may change from time to time**. The same is true of the corresponding product specifications. Please check therefore to what extent product descriptions and specifications contained in this publication are still applicable before or when you place an order.  
  
We also **reserve the right to discontinue production and delivery of products**. Consequently, we cannot guarantee that all products named in this publication will always be available. The aforementioned does not apply in the case of individual agreements deviating from the foregoing for customer-specific products.
6. Unless otherwise agreed in individual contracts, **all orders are subject to our General Terms and Conditions of Supply**.
7. **Our manufacturing sites serving the automotive business apply the IATF 16949 standard**. The IATF certifications confirm our compliance with requirements regarding the quality management system in the automotive industry. Referring to customer requirements and customer specific requirements ("CSR") TDK always has and will continue to have the policy of respecting individual agreements. Even if IATF 16949 may appear to support the acceptance of unilateral requirements, we hereby like to emphasize that **only requirements mutually agreed upon can and will be implemented in our Quality Management System**. For clarification purposes we like to point out that obligations from IATF 16949 shall only become legally binding if individually agreed upon.
8. The trade names EPCOS, CeraCharge, CeraDiode, CeraLink, CeraPad, CeraPlas, CSMP, CTVS, DeltaCap, DigiSiMic, ExoCore, FilterCap, FormFit, LeaXield, MiniBlue, MiniCell, MKD, MKK, MotorCap, PCC, PhaseCap, PhaseCube, PhaseMod, PhiCap, PowerHap, PQSine, PQvar, SIFERRIT, SIFI, SIKOREL, SilverCap, SIMDAD, SiMic, SIMID, SineFormer, SIOV, ThermoFuse, WindCap are **trademarks registered or pending** in Europe and in other countries. Further information will be found on the Internet at [www.tdk-electronics.tdk.com/trademarks](http://www.tdk-electronics.tdk.com/trademarks).