



Power Quality Solutions

Harmonic Filter Reactor

Series/Type: B44066D****M***
Ordering code: B44066D7075M440
Date: July 2018
Version: 3

© EPCOS AG 2018. Reproduction, publication and dissemination of this publication, enclosures hereto and the information contained therein without EPCOS' prior express consent is prohibited.

EPCOS AG is a TDK Group Company.

Characteristics

- Highest linearity
- Temperature control via micro switch in inner coil
- International approvals
- Highest life time by high quality materials
- Low losses
- High overloading capability
- Safety device, temperature micro switch
- Low noise

Technical data

De-tuning factor p [%]:	7
Effective filter output Q _C [kvar]:	75
Rated voltage V _R [V]: ¹⁾	440
Rated frequency [Hz]:	50
Ambient temperature / Insulation class:	40 °C/H
Capacitance C delta (tot.) [µF]:	1,145.8 (= 3 x C delta)
Inductivity L [mH]:	3 x 0.619
Linear up to [A]:	191
Effective current I _{rms} [A]: ²⁾	111.4
Rated harmonic voltages (3 rd /5 th /7 th /11 th /13 th) [%]:	0.5/6/5/3.5/3
Temperature protection (NC) :	yes
Total losses P _D [W]:	340
Total weight [kg]:	43

¹⁾ Voltage rise up to 106% of rated voltage is considered in current I_{eff}.

²⁾ $I_{\text{eff}} = \sqrt{(I_1^2 + I_3^2 + \dots I_x^2)}$

Connection

Line:	1U1-1V1-1W1
Capacitors:	1U2-1V2-1W2
Temperature control:	1-2

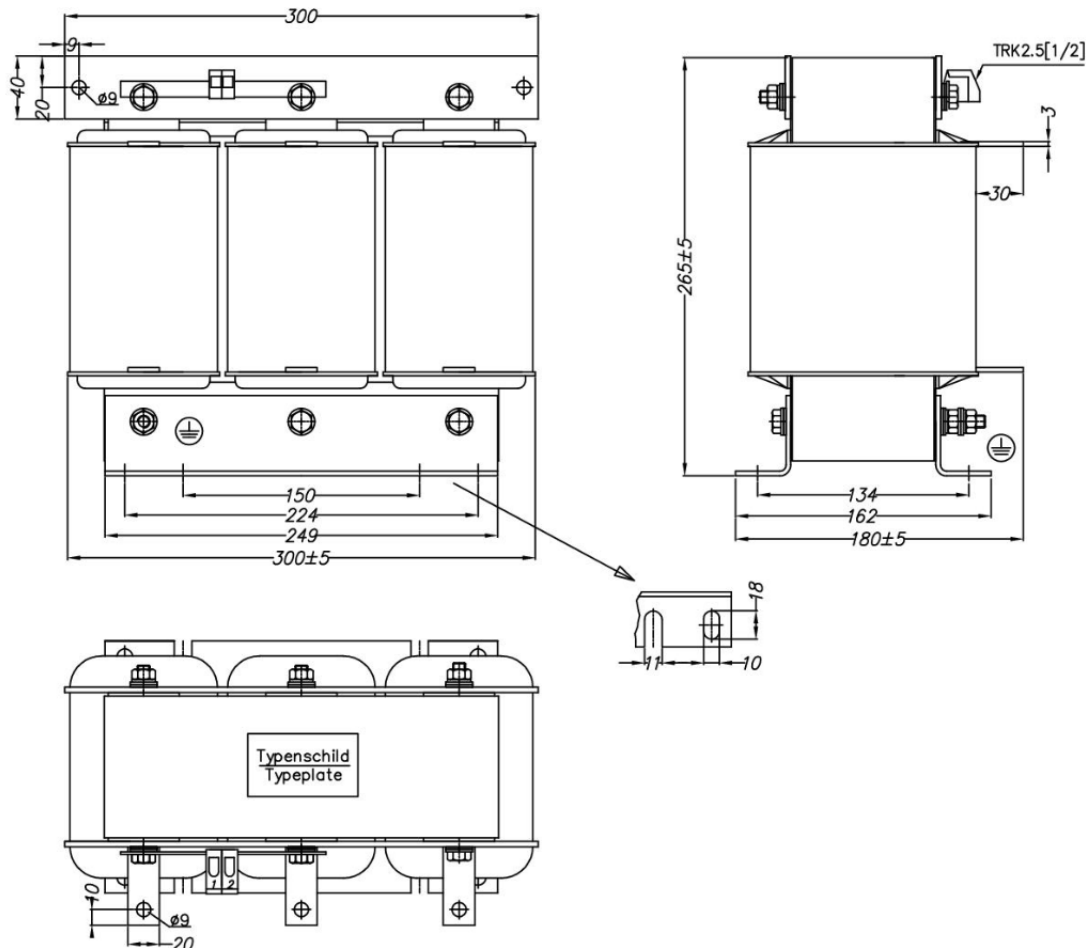
Dimensional drawing (dimensions in mm)

Cautions

- Do not install the reactor in case of any visible damages.
- Installation must be done by skilled personnel only.
- Do not use or store harmonic filter reactors in corrosive atmosphere, especially where chloride gas, sulphide gas, acid, alkali, salt or similar substances are present.
- Do not touch the device during operation: all electrically active parts of this equipment such as windings, electronic components, leads, fuses and terminals carry a dangerous voltage which can lead to burns or electric shock.
- Covers which protect these electrically active parts from being touched must not be opened or removed during operation.
- Before any assembly or maintenance work is started, all installations and equipment must be disconnected from the power source.
- Noncompliance with these instructions may lead to death, serious injury or major damage to equipment.

In order to exclude impermissible temperatures and thus overload of the insulation system, the following cautions must additionally be observed:

- Only those protective devices specified on the type plates, such as fuses and motor protection switches, may be used. It is mandatory to observe the set values specified for the motor protection switches. Any temperature-sensitive protective devices such as temperature switches and temperature sensors must be connected in accordance with the installation instructions.
- High temperatures are permissible for the surfaces under rated operating conditions, and especially in the event of overload. Depending on the temperature class and type of loading, these may attain values of up to 260 °C and may also affect adjacent components which have been packed too densely.
- The insertion position should be selected so that any cooling ducts present within the winding are arranged vertically and that the current of cooling air is not impeded by adjacent components, connecting leads etc.
- The maximum voltage of the insulating system specified on the type plate must not be exceeded. Noncompliance with these instructions may lead to considerable damage to equipment or fire due to impermissibly high temperatures.
- We strongly recommend to make use of the integrated temperature switch (NC). It will open when the maximum operation temperature for the reactor is reached. Note: This switch is a warning device only. It will not disconnect the reactor. Overheating may lead to failure of the device and subsequently to severe damage to the equipment and/or serious injury or death of human beings.

Display of ordering codes for EPCOS products

The ordering code for one and the same EPCOS product can be represented differently in data sheets, data books, other publications, on the EPCOS website, or in order-related documents such as shipping notes, order confirmations and product labels. **The varying representations of the ordering codes are due to different processes employed and do not affect the specifications of the respective products.** Detailed information can be found on the Internet under www.epcos.com/orderingcodes

Important notes

The following applies to all products named in this publication:

1. Some parts of this publication contain **statements about the suitability of our products for certain areas of application**. These statements are based on our knowledge of typical requirements that are often placed on our products in the areas of application concerned. We nevertheless expressly point out **that such statements cannot be regarded as binding statements about the suitability of our products for a particular customer application**. As a rule, EPCOS is either unfamiliar with individual customer applications or less familiar with them than the customers themselves. For these reasons, it is always ultimately incumbent on the customer to check and decide whether an EPCOS product with the properties described in the product specification is suitable for use in a particular customer application.
2. We also point out that **in individual cases, a malfunction of electronic components or failure before the end of their usual service life cannot be completely ruled out in the current state of the art, even if they are operated as specified**. In customer applications requiring a very high level of operational safety and especially in customer applications in which the malfunction or failure of an electronic component could endanger human life or health (e.g. in accident prevention or life-saving systems), it must therefore be ensured by means of suitable design of the customer application or other action taken by the customer (e.g. installation of protective circuitry or redundancy) that no injury or damage is sustained by third parties in the event of malfunction or failure of an electronic component.
3. **The warnings, cautions and product-specific notes must be observed.**
4. In order to satisfy certain technical requirements, **some of the products described in this publication may contain substances subject to restrictions in certain jurisdictions (e.g. because they are classed as hazardous)**. Useful information on this will be found in our Material Data Sheets on the Internet (www.epcos.com/material). Should you have any more detailed questions, please contact our sales offices.
5. We constantly strive to improve our products. Consequently, **the products described in this publication may change from time to time**. The same is true of the corresponding product specifications. Please check therefore to what extent product descriptions and specifications contained in this publication are still applicable before or when you place an order. We also **reserve the right to discontinue production and delivery of products**. Consequently, we cannot guarantee that all products named in this publication will always be available. The aforementioned does not apply in the case of individual agreements deviating from the foregoing for customer-specific products.
6. Unless otherwise agreed in individual contracts, **all orders are subject to the current version of the "General Terms of Delivery for Products and Services in the Electrical Industry" published by the German Electrical and Electronics Industry Association (ZVEI)**.
7. **Our manufacturing sites serving the automotive business apply the IATF 16949 standard**. The IATF certifications confirm our compliance with requirements regarding the quality management system in the automotive industry. Referring to customer requirements and customer specific requirements ("CSR") TDK always has and will continue to have the policy of respecting individual agreements. Even if IATF 16949 may appear to support the acceptance of unilateral requirements, we hereby like to emphasize that **only requirements mutually agreed upon can and will be implemented in our Quality Management System**. For clarification purposes we like to point out that obligations from IATF 16949 shall only become legally binding if individually agreed upon.

Important notes

8. The trade names EPCOS, CeraCharge, CeraDiode, CeraLink, CeraPad, CeraPlas, CSMP, CTVS, DeltaCap, DigiSiMic, ExoCore, FilterCap, FormFit, LeaXield, MiniBlue, MiniCell, MKD, MKK, MotorCap, PCC, PhaseCap, PhaseCube, PhaseMod, PhiCap, PowerHap, PQSine, PQvar, SIFERRIT, SIFI, SIKOREL, SilverCap, SIMDAD, SiMic, SIMID, SineFormer, SIOV, ThermoFuse, WindCap are **trademarks registered or pending** in Europe and in other countries. Further information will be found on the Internet at www.epcos.com/trademarks.

Release 2018-06