

Aluminum electrolytic capacitors

Capacitors with screw terminals

Series/Type: B43703, B43723

Date: August 2018

© EPCOS AG 2018. Reproduction, publication and dissemination of this publication, enclosures hereto and the information contained therein without EPCOS' prior express consent is prohibited.

EPCOS AG is a TDK Group Company.

Long-life grade capacitors

Applications

- Frequency converters
- Wind power converters
- Solar inverters
- Professional power supplies
- Uninterruptible power supplies

Features

- High CV product, i.e. extremely compact
- High reliability and high ripple current capability
- All-welded construction ensures reliable electrical contact
- PAPER terminals available (Protection Against Polarity Reversal)
- Version available with an optimized base cooling design (heat sink mounting) and featuring up to 2 times the ripple current capability
- Version with low-inductance design available (for $V_R \leq 400$ V DC)
- RoHS-compatible

Construction

- Charge-discharge proof, polar
- Aluminum case, insulated with PVC sleeve
- Version with PET insulation available upon request
- Poles with screw terminal connections
- Mounting with ring clips, clamps or threaded stud
- Types with threaded stud are available with or without insulated base

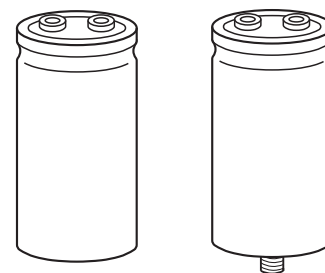
B43703
B43723

Specifications and characteristics in brief

Rated voltage V_R	350 ... 500 V DC														
Surge voltage V_S	$1.10 \cdot V_R$														
Rated capacitance C_R	1000 ... 22000 μF														
Capacitance tolerance	$\pm 20\% \triangleq M$														
Dissipation factor $\tan \delta$ (20 °C, 120 Hz)	≤ 0.20														
Leakage current I_{leak} (20 °C, 5 min)	$I_{\text{leak}} \leq 0.020 \mu\text{A} \cdot \left(\frac{C_R}{\mu\text{F}} \cdot \frac{V_R}{\text{V}} \right)^{0.85} + 4 \mu\text{A}$														
Self-inductance ESL	d = 51.6 mm: approx. 15 nH d \geq 64.3 mm: approx. 20 nH Capacitors with low-inductance design: d \geq 64.3 mm: approx. 13 nH														
Useful life ¹⁾ 85 °C; V_R ; $I_{\text{AC,R}}$	≤ 450 V DC: > 12000 h 500 V DC: > 8000 h	Requirements: $ \Delta C/C $ $\leq 15\%$ of initial value $\tan \delta$ ≤ 1.75 times initial specified limit I_{leak} \leq initial specified limit													
Voltage endurance test 85 °C; V_R	2000 h	Post test requirements: $ \Delta C/C $ $\leq 10\%$ of initial value $\tan \delta$ ≤ 1.3 times initial specified limit I_{leak} \leq initial specified limit													
Vibration resistance test	To IEC 60068-2-6, test Fc: Frequency range 10 ... 55 Hz, displacement amplitude 0.75 mm, acceleration max. 10 g. For 500 V capacitors with l > 144.5 mm only 0.35 mm displacement amplitude, acceleration max 5 g. Duration 3 \times 2 h. Capacitor mounted by its body which is rigidly clamped to the work surface.														
Characteristics at low temperature	Max. impedance ratio at 100 Hz <table border="1" data-bbox="762 1532 1445 1671"> <thead> <tr> <th>V_R</th> <th>350 V</th> <th>400 V</th> <th>≥ 450 V</th> </tr> </thead> <tbody> <tr> <td>$Z_{-25^\circ\text{C}} / Z_{20^\circ\text{C}}$</td> <td>2</td> <td>3</td> <td>3</td> </tr> <tr> <td>$Z_{-40^\circ\text{C}} / Z_{20^\circ\text{C}}$</td> <td>6</td> <td>12</td> <td>10</td> </tr> </tbody> </table>	V_R	350 V	400 V	≥ 450 V	$Z_{-25^\circ\text{C}} / Z_{20^\circ\text{C}}$	2	3	3	$Z_{-40^\circ\text{C}} / Z_{20^\circ\text{C}}$	6	12	10		
V_R	350 V	400 V	≥ 450 V												
$Z_{-25^\circ\text{C}} / Z_{20^\circ\text{C}}$	2	3	3												
$Z_{-40^\circ\text{C}} / Z_{20^\circ\text{C}}$	6	12	10												
IEC climatic category	To IEC 60068-1: $V_R = 350, 450, 500$ V DC: 40/085/56 (–40 °C/+85 °C/56 days damp heat test) $V_R = 400$ V DC: 25/085/56 (–25 °C/+85 °C/56 days damp heat test) The capacitors can be operated in the temperature range of –40 °C to +85 °C but the impedance at –40 °C must be taken into consideration.														
Sectional specification	IEC 60384-4														

1) Refer to chapter "General technical information, 5 Useful life" on how to interpret useful life.

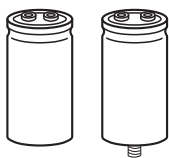

B43703, B43723

Extremely compact – 85 °C

Ripple current capability

Due to the ripple current capability of the contact elements, the following current upper limits must not be exceeded:

Capacitor diameter	51.6 mm	64.3 mm	76.9 mm	90 mm
$I_{AC,max}$	34 A	57 A	74 A	89 A

Dimensional drawings

B43703

Ring clip/clamp mounting

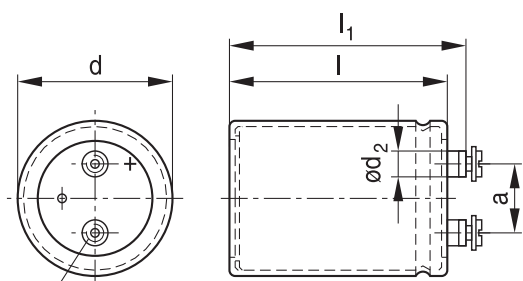

KAL1318-B-E

B43723

Threaded stud mounting

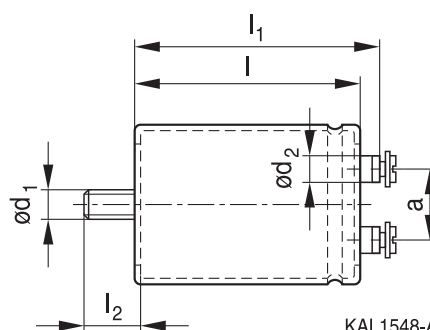

KAL1548-A

- M5: Min. reach of screw = 9.5 mm
9 mm for low inductance design
- M6: Min. reach of screw = 12 mm
9.5 mm for low inductance design

Positive pole marking: +

For standard types with threaded stud the base is not insulated. Also refer to the mounting instructions in chapter "Capacitors with screw terminals – Accessories".

Screw terminals with UNF threads are available upon request.

Dimensions and weights (Standard capacitors, without heat sink)

Ter- minal	Dimensions (mm) with insulating sleeve							Approx. weight (g)
	d	l ±1	l ₁ ±1	l ₂ +0/–1	d ₁	d ₂ max.	a +0.2/–0.4	
M5	51.6 +0.5/–1	80.7	87.2	17	M12	10.2	22.2	220
M5	51.6 +0.5/–1	96.7	103.2	17	M12	10.2	22.2	250
M5	51.6 +0.5/–1	105.7	112.2	17	M12	10.2	22.2	280
M5	51.6 +0.5/–1	118.2	124.7	17	M12	10.2	22.2	320
M5	51.6 +0.5/–1	130.7	137.2	17	M12	10.2	22.2	350
M5	64.3 +0.5/–1	80.7	87.2	17	M12	13.2	28.5	370
M5	64.3 +0.5/–1	96.7	103.2	17	M12	13.2	28.5	400
M5	64.3 +0.5/–1	105.7	112.2	17	M12	13.2	28.5	440
M5	64.3 +0.5/–1	118.2	124.7	17	M12	13.2	28.5	510
M5	64.3 +0.5/–1	130.7	137.2	17	M12	13.2	28.5	600
M5	64.3 +0.5/–1	143.2	149.7	17	M12	13.2	28.5	630
M6	76.9 +0.5/–1	96.7	102.5	17	M12	17.7	31.7	570
M6	76.9 +0.5/–1	105.7	111.5	17	M12	17.7	31.7	620
M6	76.9 +0.5/–1	118.2	124.0	17	M12	17.7	31.7	700
M6	76.9 +0.5/–1	130.7	136.5	17	M12	17.7	31.7	800
M6	76.9 +0.5/–1	143.2	149.0	17	M12	17.7	31.7	840
M6	76.9 +0.5/–1	156.2	162.0	17	M12	17.7	31.7	920
M6	76.9 +0.5/–1	168.7	174.5	17	M12	17.7	31.7	1000
M6	76.9 +0.5/–1	190.7	196.5	17	M12	17.7	31.7	1150
M6	76.9 +0.5/–1	220.7	226.5	17	M12	17.7	31.7	1300
M6	90.0 +0.5/–1.5	120.0	125.3	17	M12	17.7	31.7	1000
M6	90.0 +0.5/–1.5	144.5	149.8	17	M12	17.7	31.7	1200
M6	90.0 +0.5/–1.5	170.0	175.3	17	M12	17.7	31.7	1400
M6	90.0 +0.5/–1.5	191.0	196.3	17	M12	17.7	31.7	1650
M6	90.0 +0.5/–1.5	197.0	202.3	17	M12	17.7	31.7	1700
M6	90.0 +0.5/–1.5	221.0	226.3	17	M12	17.7	31.7	1900

Tolerances of terminal thread respectively stud thread:

- Terminal thread M5 and M6: 6H
- Thread of stud M12: 6g

For low-inductance design the following deviation applies:

d = 64.3 mm: l₁ –0.7 mm

d = 90.0 mm: l₁ –1.7 mm

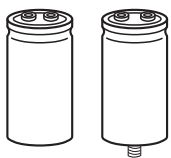

B43703, B43723

Extremely compact – 85 °C

Packing

Capacitor diameter d (mm)	Length l (mm)	Packing units (pcs.)
51.6	all	36
64.3	all	25
76.9	≤168.7	16
	>168.7	12
90.0	all	9



For ecological reasons the packing is pure cardboard.

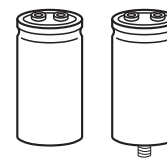

Special designs

- Low-inductance design
- PAPER terminal style

With our PAPER terminal style (**P**rotection **A**gainst **P**olarity **R**eversal) we offer an optional mechanical feature in addition to the visual polarity marking on the cover disk and the sleeve, which prevents from mounting in reverse polarity. The non-circular shape of the terminals and their arrangement perpendicular to each other enables the user to definitely prevent wrong mounting with respect to polarity (Poka Yoke).

Dimensional drawing of PAPER terminal configuration:

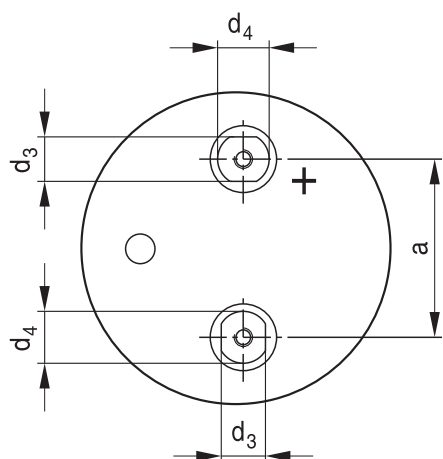

KAL1317-3

Dimensions for PAPER terminal style (mm):

Can diameter d	Terminal	$d_3 \pm 0.1$	$d_4 \pm 0.1$	a +0.2/−0.4	Min. reach of screw	
					Standard design #050	For heat sink mounting #057
51.6	M5	10	13	22.2	9.5	—
64.3	M5	13	15	28.5	9.5	7.3
76.9	M6	13	15	31.7	12.0	9.7
90.0	M6	13	15	31.7	12.0	9.7

Tolerances of terminal thread respectively stud thread:

- Terminal thread M5 and M6: 6H
- Thread of stud M12: 6g

All other dimensions of the capacitor such as diameter d, case length l and overall length l_1 are identical with those of standard capacitors of this series. Please refer to the tables "Dimensions and weights" (standard types) and "Dimensions and weights for heat sink mounting" (special designs).

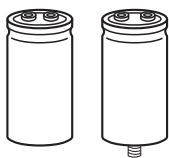

B43703, B43723

Extremely compact – 85 °C

■ For heat sink mounting

Please refer to chapter "General technical information, 5.2.2 Base cooling with heat sink". This version is available only for capacitors without threaded stud and for diameters ≥ 64.3 mm. Regarding ripple current and useful life, please refer to chapter "General technical information, 5 Useful life".

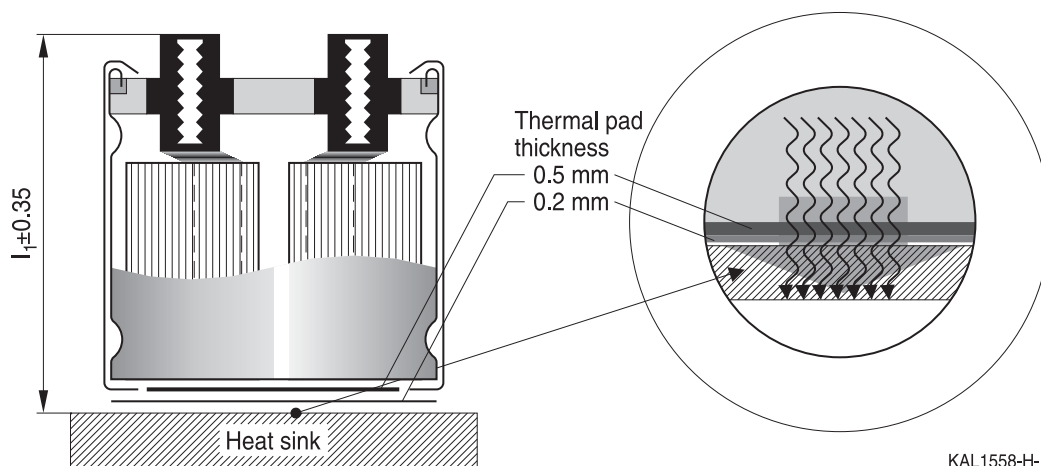

Dimensions and weights for heat sink mounting:

Terminal	Dimensions (mm) with insulating sleeve					Approx. weight g
	d	$l \pm 1$	$l_1 \pm 0.35$	d_2 max.	$a + 0.2 / - 0.4$	
M5	$64.3 + 0.5 / - 1$	80.7	86.3	13.2	28.5	370
M5	$64.3 + 0.5 / - 1$	96.7	111.3	13.2	28.5	440
M6	$76.9 + 0.5 / - 1$	96.7	101.6	17.7	31.7	570
M6	$76.9 + 0.5 / - 1$	105.7	110.6	17.7	31.7	620
M6	$76.9 + 0.5 / - 1$	118.2	123.1	17.7	31.7	700
M6	$90.0 + 0.5 / - 1.5$	120.0	124.4	17.7	31.7	1000
M6	$90.0 + 0.5 / - 1.5$	144.5	148.9	17.7	31.7	1200

Tolerances of terminal thread respectively stud thread:

- Terminal thread M5 and M6: 6H
- Thread of stud M12: 6g

Dimensions for other sizes are available upon request.

■ Insulated base

Length l and l_1 increase by +0.5 mm for types with threaded stud and insulated base. All other dimensions of the capacitor are identical with those of standard capacitors of this series.

Please refer to the table "Dimensions and weights".

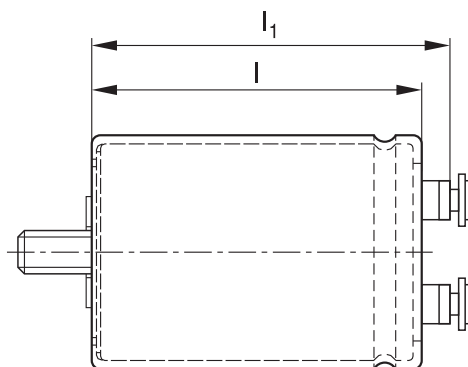

KAL1627-T



Design options

Design options	Identification in third block of ordering code	Remark
Standard	M000	Standard version without threaded stud: fully insulated with PVC Standard version with threaded stud: insulated with PVC sleeve, base not insulated
Low inductance (13 nH)	M003	For capacitors with diameter $d \geq 64.3$ mm and $V_R \leq 400$ V
Heat sink mounting	M007	For capacitors with diameter $d \geq 64.3$ mm and without threaded stud
Insulated base	M008	For capacitors with threaded stud, fully insulated with PVC sleeve and PP disc
PAPR (terminal style)	M050	Not for low inductance
PAPR with heat sink mounting	M057	For capacitors with diameter $d \geq 64.3$ mm and without threaded stud, not for low inductance
PAPR with insulated base	M058	For capacitors with threaded stud, fully insulated with PVC sleeve and PP disc, not for low inductance

Version with low inductance (13 nH) in combination with insulated base (threaded stud) available upon request

Accessories

The following items are included in the delivery package, but are not fastened to the capacitors:

	Thread	Toothed washers	Screws/nuts	Maximum torque
For terminals	M5	A 5.1 DIN 6797	DIN 7985 / ISO 7045-M5 × 10-5.6-Z	2.5 Nm thread depth $t \geq 8$ mm
	M6	A 6.4 DIN 6797	DIN 7985 / ISO 7045-M6 × 12-5.6-Z	4.0 Nm thread depth $t \geq 9.5$ mm
For mounting	M12	J 12.5 DIN 6797	Hex nut BM 12 DIN 439	10 Nm

The following items must be ordered separately. For details, refer to chapter "Capacitors with screw terminals – Accessories".

Item	Type
Ring clips	B44030
Clamps for capacitors with $d \geq 64.3$ mm	B44030
Insulating parts	B44020

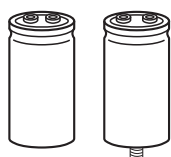

B43703, B43723

Extremely compact – 85 °C

Overview of available types

The capacitance and voltage ratings listed below are available in different case sizes upon request. Other voltage and capacitance ratings are also available upon request.

V_R (V DC)	350	400	450	500
	Case dimensions $d \times l$ (mm)			
C_R (μ F)				
1000				51.6 × 80.7
1200				51.6 × 96.7
1500			51.6 × 80.7	51.6 × 96.7
1800		51.6 × 80.7	51.6 × 96.7	51.6 × 118.2
2200	51.6 × 80.7	51.6 × 96.7	51.6 × 105.7 64.3 × 80.7	64.3 × 96.7
2700	51.6 × 96.7	51.6 × 105.7 64.3 × 80.7	51.6 × 118.2 64.3 × 96.7	64.3 × 105.7
3300	51.6 × 105.7 64.3 × 80.7	51.6 × 130.7 64.3 × 96.7	64.3 × 96.7	64.3 × 130.7 76.9 × 96.7
3900	51.6 × 118.2 64.3 × 96.7	64.3 × 96.7	64.3 × 118.2 76.9 × 96.7	64.3 × 143.2 76.9 × 118.2
4700	64.3 × 96.7	64.3 × 118.2 76.9 × 96.7	64.3 × 130.7 76.9 × 105.7	76.9 × 130.7 90.0 × 120.0
5600	64.3 × 118.2 76.9 × 96.7	64.3 × 130.7 76.9 × 105.7	64.3 × 143.2 76.9 × 118.2	76.9 × 143.2 90.0 × 120.0
6800	64.3 × 130.7 76.9 × 105.7	76.9 × 118.2	76.9 × 130.7 90.0 × 120.0	76.9 × 168.7 90.0 × 144.5
8200	76.9 × 118.2	76.9 × 130.7 90.0 × 120.0	76.9 × 156.2 90.0 × 144.5	76.9 × 190.7 90.0 × 170.0
10000	76.9 × 130.7 90.0 × 120.0	76.9 × 156.2 90.0 × 144.5	76.9 × 190.7 90.0 × 144.5	90.0 × 191.0
12000	76.9 × 156.2 90.0 × 144.5	76.9 × 190.7 90.0 × 144.5	76.9 × 220.7 90.0 × 170.0	90.0 × 221.0
15000	76.9 × 190.7 90.0 × 144.5	76.9 × 220.7 90.0 × 170.0	90.0 × 197.0	
18000	76.9 × 220.7 90.0 × 170.0	90.0 × 197.0		
22000	90.0 × 197.0			

Technical data and ordering codes

C_R 100 Hz 20 °C μF	Case dimensions $d \times l$ mm	ESR_{typ} 100 Hz 20 °C m Ω	ESR_{typ} 300 Hz 60 °C m Ω	Z_{max} 10 kHz 20 °C m Ω	$I_{\text{AC,max}}$ 100 Hz 60 °C A	$I_{\text{AC,R}}$ 100 Hz 85 °C A	Ordering code (composition see below)
$V_R = 350 \text{ V DC}$							
2200	51.6 × 80.7	34	15	50	13.8	7.63	B437*3A4228M0##
2700	51.6 × 96.7	28	12	40	16.0	8.84	B437*3A4278M0##
3300	51.6 × 105.7	24	10	34	18.1	9.97	B437*3A4338M0##
3300	64.3 × 80.7	24	10	34	18.8	10.3	B437*3B4338M0##
3900	51.6 × 118.2	20	9.1	30	20.2	11.1	B437*3A4398M0##
3900	64.3 × 96.7	19	8.1	28	21.2	11.7	B437*3B4398M0##
4700	64.3 × 96.7	17	7.8	26	23.0	12.6	B437*3A4478M0##
5600	64.3 × 118.2	14	6.2	20	26.3	14.5	B437*3A4568M0##
5600	76.9 × 96.7	13	5.5	19	29.4	16.1	B437*3B4568M0##
6800	64.3 × 130.7	12	5.6	18	29.6	16.3	B437*3A4688M0##
6800	76.9 × 105.7	11	4.8	16	32.8	18.0	B437*3B4688M0##
8200	76.9 × 118.2	9.4	4.1	14	36.7	20.2	B437*3A4828M0##
10000	76.9 × 130.7	7.9	3.6	12	41.2	22.7	B437*3A4109M0##
10000	90.0 × 120.0	7.5	3.2	11	45.0	25.7	B437*3B4109M0##
12000	76.9 × 156.2	6.6	3.0	10	46.8	25.7	B437*3A4129M0##
12000	90.0 × 144.5	6.2	2.6	9.4	50.4	28.8	B437*3B4129M0##
15000	76.9 × 190.7	5.3	2.5	8.4	54.6	31.2	B437*3A4159M0##
15000	90.0 × 144.5	5.3	2.5	8.4	56.6	32.3	B437*3B4159M0##
18000	76.9 × 220.7	4.5	2.1	7.4	62.0	35.4	B437*3A4189M0##
18000	90.0 × 170.0	4.4	2.1	7.4	63.6	36.3	B437*3B4189M0##
22000	90.0 × 197.0	3.7	1.8	6.6	72.4	41.3	B437*3A4229M0##

Composition of ordering code

* = Mounting style

- 0 = for capacitors with ring clip/clamp mounting
- 2 = for capacitors with threaded stud

= Design

- 00 = standard
- 03 = low inductance (13 nH)
- 07 = heat sink mounting
- 08 = insulated base
- 50 = PAPR (terminal style)
- 57 = PAPR with heat sink mounting
- 58 = PAPR with insulated base

For details refer to "Design options" on page 9.

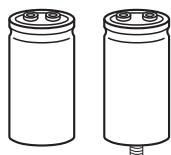

B43703, B43723

Extremely compact – 85 °C

Technical data and ordering codes

C_R 100 Hz 20 °C μF	Case dimensions $d \times l$ mm	ESR_{typ} 100 Hz 20 °C m Ω	ESR_{typ} 300 Hz 60 °C m Ω	Z_{max} 10 kHz 20 °C m Ω	$I_{\text{AC,max}}$ 100 Hz 60 °C A	$I_{\text{AC,R}}$ 100 Hz 85 °C A	Ordering code (composition see below)
$V_R = 400 \text{ V DC}$							
1800	51.6 × 80.7	65	20	100	12.5	6.91	B437*3A9188M0##
2200	51.6 × 96.7	50	16	80	14.4	7.99	B437*3A9228M0##
2700	51.6 × 105.7	45	14	70	16.4	9.08	B437*3A9278M0##
2700	64.3 × 80.7	40	14	65	17.0	9.39	B437*3B9278M0##
3300	51.6 × 130.7	34	11	55	19.2	10.6	B437*3A9338M0##
3300	64.3 × 96.7	34	11	55	19.5	10.7	B437*3B9338M0##
3900	64.3 × 96.7	30	10	50	21.2	11.6	B437*3A9398M0##
4700	64.3 × 118.2	24	8.3	40	24.3	13.4	B437*3A9478M0##
4700	76.9 × 96.7	24	7.5	38	26.8	14.7	B437*3B9478M0##
5600	64.3 × 130.7	20	7.3	34	27.3	15.0	B437*3A9568M0##
5600	76.9 × 105.7	20	6.5	32	29.8	16.4	B437*3B9568M0##
6800	76.9 × 118.2	17	5.6	28	33.6	18.4	B437*3A9688M0##
8200	76.9 × 130.7	14	4.8	24	37.8	20.8	B437*3A9828M0##
8200	90.0 × 120.0	14	4.4	22	40.7	23.2	B437*3B9828M0##
10000	76.9 × 156.2	12	4.0	19	43.3	23.8	B437*3A9109M0##
10000	90.0 × 144.5	11	3.6	18	46.0	26.3	B437*3B9109M0##
12000	76.9 × 190.7	9.6	3.3	16	49.4	28.2	B437*3A9129M0##
12000	90.0 × 144.5	9.7	3.3	16	51.1	29.2	B437*3B9129M0##
15000	76.9 × 220.7	7.8	2.8	13	57.8	33.0	B437*3A9159M0##
15000	90.0 × 170.0	7.8	2.7	13	59.0	33.7	B437*3B9159M0##
18000	90.0 × 197.0	6.6	2.4	12	66.8	38.1	B437*3A9189M0##

Composition of ordering code

* = Mounting style

- 0 = for capacitors with ring clip/clamp mounting
- 2 = for capacitors with threaded stud

= Design

- 00 = standard
- 03 = low inductance (13 nH)
- 07 = heat sink mounting
- 08 = insulated base
- 50 = PAPR (terminal style)
- 57 = PAPR with heat sink mounting
- 58 = PAPR with insulated base

For details refer to "Design options" on page 9.

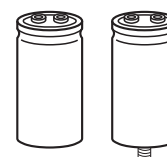
Technical data and ordering codes

C_R 100 Hz 20 °C μF	Case dimensions $d \times l$ mm	ESR_{typ} 100 Hz 20 °C m Ω	ESR_{typ} 300 Hz 60 °C m Ω	Z_{max} 10 kHz 20 °C m Ω	$I_{\text{AC,max}}$ 100 Hz 60 °C A	$I_{\text{AC,R}}$ 100 Hz 85 °C A	Ordering code (composition see below)
$V_R = 450 \text{ V DC}$							
1500	51.6 × 80.7	65	22	100	11.8	6.51	B437*3A5158M0##
1800	51.6 × 96.7	55	18	80	13.4	7.43	B437*3A5188M0##
2200	51.6 × 105.7	45	15	70	15.3	8.44	B437*3A5228M0##
2200	64.3 × 80.7	45	15	70	15.8	8.76	B437*3B5228M0##
2700	51.6 × 118.2	36	13	55	17.5	9.66	B437*3A5278M0##
2700	64.3 × 96.7	36	12	55	18.1	10.0	B437*3B5278M0##
3300	64.3 × 96.7	30	11	50	20.1	11.0	B437*3A5338M0##
3900	64.3 × 118.2	26	8.9	38	22.8	12.5	B437*3A5398M0##
3900	76.9 × 96.7	24	8.1	38	25.2	13.8	B437*3B5398M0##
4700	64.3 × 130.7	22	7.8	34	25.7	14.1	B437*3A5478M0##
4700	76.9 × 105.7	20	7.0	32	28.1	15.4	B437*3B5478M0##
5600	64.3 × 143.2	18	6.9	28	28.8	15.8	B437*3A5568M0##
5600	76.9 × 118.2	17	6.0	28	31.3	17.2	B437*3B5568M0##
6800	76.9 × 130.7	15	5.2	22	35.3	19.4	B437*3A5688M0##
6800	90.0 × 120.0	14	4.7	22	38.1	21.8	B437*3B5688M0##
8200	76.9 × 156.2	12	4.3	19	40.2	22.1	B437*3A5828M0##
8200	90.0 × 144.5	12	3.9	18	42.7	24.5	B437*3B5828M0##
10000	76.9 × 190.7	9.9	3.5	16	46.2	26.4	B437*3A5109M0##
10000	90.0 × 144.5	9.9	3.5	16	48.0	27.4	B437*3B5109M0##
12000	76.9 × 220.7	8.3	3.0	13	52.5	30.1	B437*3A5129M0##
12000	90.0 × 170.0	8.3	3.0	13	54.0	30.9	B437*3B5129M0##
15000	90.0 × 197.0	6.7	2.5	11	62.4	35.7	B437*3A5159M0##

Composition of ordering code

* = Mounting style

0 = for capacitors with ring clip/clamp mounting

2 = for capacitors with threaded stud

= Design

00 = standard

03 = low inductance (13 nH)

07 = heat sink mounting

08 = insulated base

50 = PAPR (terminal style)

57 = PAPR with heat sink mounting

58 = PAPR with insulated base

For details refer to "Design options" on page 9.

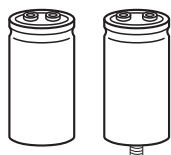

B43703, B43723

Extremely compact – 85 °C

Technical data and ordering codes

C_R 100 Hz 20 °C μF	Case dimensions $d \times l$ mm	ESR_{typ} 100 Hz 20 °C $\text{m}\Omega$	ESR_{typ} 300 Hz 60 °C $\text{m}\Omega$	Z_{max} 10 kHz 20 °C $\text{m}\Omega$	$I_{\text{AC,max}}$ 100 Hz 60 °C A	$I_{\text{AC,R}}$ 100 Hz 85 °C A	Ordering code (composition see below)
$V_R = 500 \text{ V DC}$							
1000	51.6 × 80.7	75	22	110	10.6	5.32	B437*3A6108M0##
1200	51.6 × 96.7	60	18	85	12.0	6.02	B437*3A6128M0##
1500	51.6 × 96.7	50	15	70	13.9	6.98	B437*3A6158M0##
1800	51.6 × 118.2	40	13	60	15.9	7.96	B437*3A6188M0##
2200	64.3 × 96.7	34	11	50	18.1	9.09	B437*3A6228M0##
2700	64.3 × 105.7	28	9.3	40	20.7	10.3	B437*3A6278M0##
3300	64.3 × 130.7	24	7.5	32	23.9	11.9	B437*3A6338M0##
3300	76.9 × 96.7	24	8.1	34	24.5	12.2	B437*3B6338M0##
3900	64.3 × 143.2	20	6.5	28	26.8	13.4	B437*3A6398M0##
3900	76.9 × 118.2	20	6.6	28	27.3	13.6	B437*3B6398M0##
4700	76.9 × 130.7	16	5.7	24	30.8	15.4	B437*3A6478M0##
4700	90.0 × 120.0	16	5.3	24	32.9	17.0	B437*3B6478M0##
5600	76.9 × 143.2	14	5.0	20	34.5	17.2	B437*3A6568M0##
5600	90.0 × 120.0	14	4.8	20	36.6	18.9	B437*3B6568M0##
6800	76.9 × 168.7	12	4.2	17	39.5	20.4	B437*3A6688M0##
6800	90.0 × 144.5	11	4.0	17	41.3	21.3	B437*3B6688M0##
8200	76.9 × 190.7	9.7	3.6	14	45.1	23.3	B437*3A6828M0##
8200	90.0 × 170.0	9.5	3.3	14	46.5	24.0	B437*3B6828M0##
10000	90.0 × 191.0	7.9	2.8	12	53.0	27.4	B437*3A6109M0##
12000	90.0 × 221.0	6.6	2.4	9.9	59.9	31.0	B437*3A6129M0##

Composition of ordering code

* = Mounting style

0 = for capacitors with ring clip/clamp mounting

2 = for capacitors with threaded stud

= Design

00 = standard

03 = low inductance (13 nH)

07 = heat sink mounting

08 = insulated base

50 = PAPR (terminal style)

57 = PAPR with heat sink mounting

58 = PAPR with insulated base

For details refer to "Design options" on page 9.

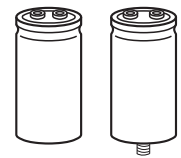

Useful life¹⁾

For useful life calculations, please use our web-based "AlCap Useful Life Calculation Tool", which can be found on the Internet under the following link:

http://www.epcos.com/designtools/alu_useful_life/Useful_life.swf

The AlCap Useful Life Calculation Tool provides calculations of useful life as well as additional data for selected capacitor types under operating conditions defined by the user.

Frequency characteristics of ESR

Typical behavior

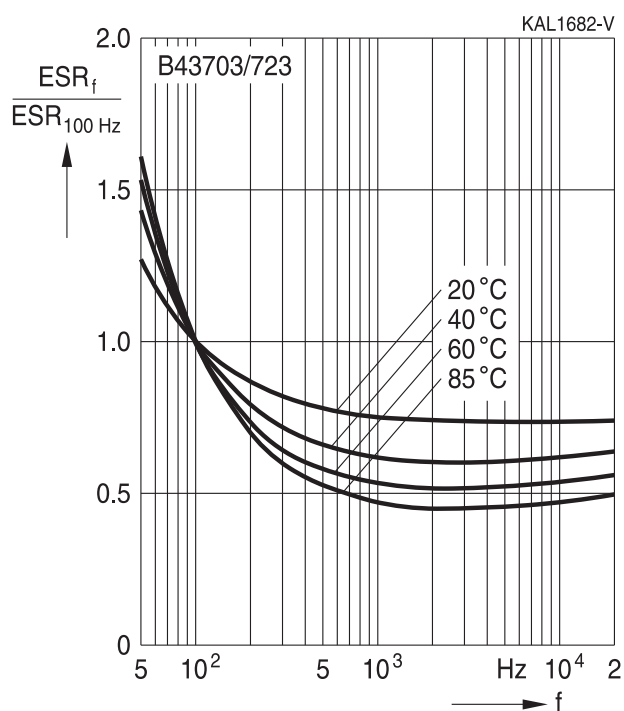

Impedance Z versus frequency f

Typical behavior at 20 °C

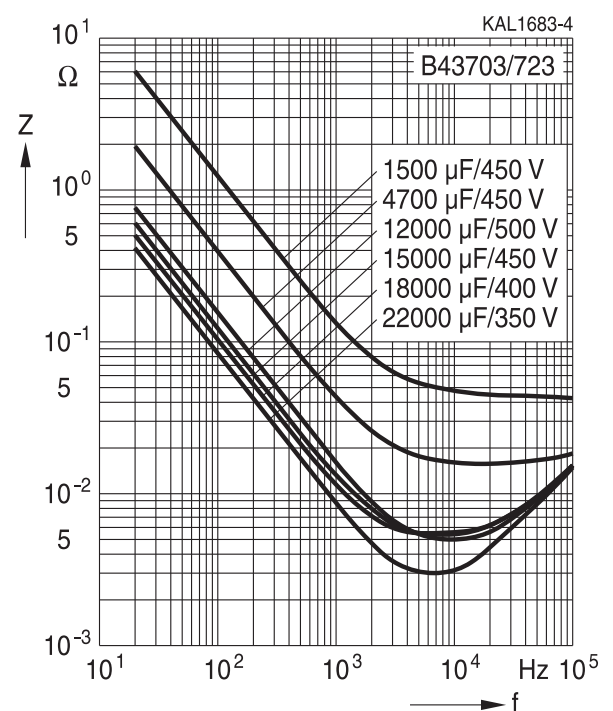

1) Refer to chapter "General technical information, 5 Useful life" on how to interpret useful life.

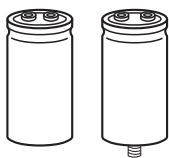

B43703, B43723

Extremely compact – 85 °C

Cautions and warnings

Personal safety

The electrolytes used by EPCOS have been optimized both with a view to the intended application and with regard to health and environmental compatibility. They do not contain any solvents that are detrimental to health, e.g. dimethyl formamide (DMF) or dimethyl acetamide (DMAC).

Furthermore, some of the high-voltage electrolytes used by EPCOS are self-extinguishing.

As far as possible, EPCOS does not use any dangerous chemicals or compounds to produce operating electrolytes, although in exceptional cases, such materials must be used in order to achieve specific physical and electrical properties because no alternative materials are currently known. We do, however, restrict the amount of dangerous materials used in our products to an absolute minimum.

Materials and chemicals used in EPCOS aluminum electrolytic capacitors are continuously adapted in compliance with the EPCOS Corporate Environmental Policy and the latest EU regulations and guidelines such as RoHS, REACH/SVHC, GADSL, and ELV.

MDS (Material Data Sheets) are available on the EPCOS website for all types listed in the data book. MDS for customer specific capacitors are available upon request.

MSDS (Material Safety Data Sheets) are available for all of our electrolytes upon request.

Nevertheless, the following rules should be observed when handling aluminum electrolytic capacitors: No electrolyte should come into contact with eyes or skin. If electrolyte does come into contact with the skin, wash the affected areas immediately with running water. If the eyes are affected, rinse them for 10 minutes with plenty of water. If symptoms persist, seek medical treatment. Avoid inhaling electrolyte vapor or mists. Workplaces and other affected areas should be well ventilated. Clothing that has been contaminated by electrolyte must be changed and rinsed in water.

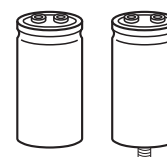

Product safety

The table below summarizes the safety instructions that must be observed without fail. A detailed description can be found in the relevant sections of chapter "General technical information".

Topic	Safety information	Reference chapter "General technical information"
Polarity	Make sure that polar capacitors are connected with the right polarity.	1 "Basic construction of aluminum electrolytic capacitors"
Reverse voltage	Voltages of opposite polarity should be prevented by connecting a diode.	3.1.6 "Reverse voltage"
Mounting position of screw-terminal capacitors	Screw terminal capacitors must not be mounted with terminals facing down unless otherwise specified.	11.1. "Mounting positions of capacitors with screw terminals"
Robustness of terminals	The following maximum tightening torques must not be exceeded when connecting screw terminals: M5: 2.5 Nm M6: 4.0 Nm	11.3 "Mounting torques"
Mounting of single-ended capacitors	The internal structure of single-ended capacitors might be damaged if excessive force is applied to the lead wires. Avoid any compressive, tensile or flexural stress. Do not move the capacitor after soldering to PC board. Do not pick up the PC board by the soldered capacitor. Do not insert the capacitor on the PC board with a hole space different to the lead space specified.	11.4 "Mounting considerations for single-ended capacitors"
Soldering	Do not exceed the specified time or temperature limits during soldering.	11.5 "Soldering"
Soldering, cleaning agents	Do not allow halogenated hydrocarbons to come into contact with aluminum electrolytic capacitors.	11.6 "Cleaning agents"
Upper category temperature	Do not exceed the upper category temperature.	7.2 "Maximum permissible operating temperature"
Passive flammability	Avoid external energy, e.g. fire.	8.1 "Passive flammability"

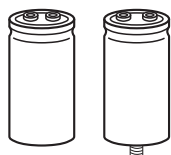

B43703, B43723

Extremely compact – 85 °C

Topic	Safety information	Reference chapter "General technical information"
Active flammability	Avoid overload of the capacitors.	8.2 "Active flammability"
Maintenance	Make periodic inspections of the capacitors. Before the inspection, make sure that the power supply is turned off and carefully discharge the capacitors. Do not apply excessive mechanical stress to the capacitor terminals when mounting.	10 "Maintenance"
Storage	Do not store capacitors at high temperatures or high humidity. Capacitors should be stored at +5 to +35 °C and a relative humidity of ≤ 75%.	7.3 "Shelf life and storage conditions"
		Reference chapter "Capacitors with screw terminals"
Breakdown strength of insulating sleeves	Do not damage the insulating sleeve, especially when ring clips are used for mounting.	"Screw terminals – accessories"

Display of ordering codes for EPCOS products

The ordering code for one and the same product can be represented differently in data sheets, data books, other publications and the website of EPCOS, or in order-related documents such as shipping notes, order confirmations and product labels. The varying representations of the ordering codes are due to different processes employed and do not affect the specifications of the respective products.

Detailed information can be found on the Internet under www.epcos.com/orderingcodes.



Symbols and terms

Symbol	English	German
C	Capacitance	Kapazität
C_R	Rated capacitance	Nennkapazität
C_S	Series capacitance	Serienkapazität
$C_{S,T}$	Series capacitance at temperature T	Serienkapazität bei Temperatur T
C_f	Capacitance at frequency f	Kapazität bei Frequenz f
d	Case diameter, nominal dimension	Gehäusedurchmesser, Nennmaß
d_{max}	Maximum case diameter	Maximaler Gehäusedurchmesser
ESL	Self-inductance	Eigeninduktivität
ESR	Equivalent series resistance	Ersatzserienwiderstand
ESR_f	Equivalent series resistance at frequency f	Ersatzserienwiderstand bei Frequenz f
ESR_T	Equivalent series resistance at temperature T	Ersatzserienwiderstand bei Temperatur T
f	Frequency	Frequenz
I	Current	Strom
I_{AC}	Alternating current (ripple current)	Wechselstrom
$I_{AC,RMS}$	Root-mean-square value of alternating current	Wechselstrom, Effektivwert
$I_{AC,f}$	Ripple current at frequency f	Wechselstrom bei Frequenz f
$I_{AC,max}$	Maximum permissible ripple current	Maximal zulässiger Wechselstrom
$I_{AC,R}$	Rated ripple current	Nennwechselstrom
I_{leak}	Leakage current	Reststrom
$I_{leak,op}$	Operating leakage current	Betriebsreststrom
l	Case length, nominal dimension	Gehäuselänge, Nennmaß
l_{max}	Maximum case length (without terminals and mounting stud)	Maximale Gehäuselänge (ohne Anschlüsse und Gewindebolzen)
R	Resistance	Widerstand
R_{ins}	Insulation resistance	Isolationswiderstand
R_{symm}	Balancing resistance	Symmetrierwiderstand
T	Temperature	Temperatur
ΔT	Temperature difference	Temperaturdifferenz
T_A	Ambient temperature	Umgebungstemperatur
T_C	Case temperature	Gehäusetemperatur
T_B	Capacitor base temperature	Temperatur des Gehäusebodens
t	Time	Zeit
Δt	Period	Zeitraum
t_b	Service life (operating hours)	Brauchbarkeitsdauer (Betriebszeit)

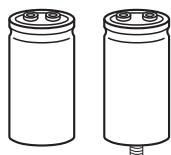

B43703, B43723

Extremely compact – 85 °C

Symbol	English	German
V	Voltage	Spannung
V_F	Forming voltage	Formierspannung
V_{op}	Operating voltage	Betriebsspannung
V_R	Rated voltage, DC voltage	Nennspannung, Gleichspannung
V_S	Surge voltage	Spitzenspannung
X_C	Capacitive reactance	Kapazitiver Blindwiderstand
X_L	Inductive reactance	Induktiver Blindwiderstand
Z	Impedance	Scheinwiderstand
Z_T	Impedance at temperature T	Scheinwiderstand bei Temperatur T
$\tan \delta$	Dissipation factor	Verlustfaktor
λ	Failure rate	Ausfallrate
ϵ_0	Absolute permittivity	Elektrische Feldkonstante
ϵ_r	Relative permittivity	Dielektrizitätszahl
ω	Angular velocity; $2 \cdot \pi \cdot f$	Kreisfrequenz; $2 \cdot \pi \cdot f$

Note

All dimensions are given in mm.

Important notes

The following applies to all products named in this publication:

1. Some parts of this publication contain **statements about the suitability of our products for certain areas of application**. These statements are based on our knowledge of typical requirements that are often placed on our products in the areas of application concerned. We nevertheless expressly point out **that such statements cannot be regarded as binding statements about the suitability of our products for a particular customer application**. As a rule, EPCOS is either unfamiliar with individual customer applications or less familiar with them than the customers themselves. For these reasons, it is always ultimately incumbent on the customer to check and decide whether an EPCOS product with the properties described in the product specification is suitable for use in a particular customer application.
2. We also point out that **in individual cases, a malfunction of electronic components or failure before the end of their usual service life cannot be completely ruled out in the current state of the art, even if they are operated as specified**. In customer applications requiring a very high level of operational safety and especially in customer applications in which the malfunction or failure of an electronic component could endanger human life or health (e.g. in accident prevention or lifesaving systems), it must therefore be ensured by means of suitable design of the customer application or other action taken by the customer (e.g. installation of protective circuitry or redundancy) that no injury or damage is sustained by third parties in the event of malfunction or failure of an electronic component.
3. **The warnings, cautions and product-specific notes must be observed.**
4. In order to satisfy certain technical requirements, **some of the products described in this publication may contain substances subject to restrictions in certain jurisdictions (e.g. because they are classed as hazardous)**. Useful information on this will be found in our Material Data Sheets on the Internet (www.epcos.com/material). Should you have any more detailed questions, please contact our sales offices.
5. We constantly strive to improve our products. Consequently, **the products described in this publication may change from time to time**. The same is true of the corresponding product specifications. Please check therefore to what extent product descriptions and specifications contained in this publication are still applicable before or when you place an order. We also **reserve the right to discontinue production and delivery of products**. Consequently, we cannot guarantee that all products named in this publication will always be available. The aforementioned does not apply in the case of individual agreements deviating from the foregoing for customer-specific products.
6. Unless otherwise agreed in individual contracts, **all orders are subject to the current version of the "General Terms of Delivery for Products and Services in the Electrical Industry" published by the German Electrical and Electronics Industry Association (ZVEI)**.

Important notes

7. **Our manufacturing sites serving the automotive business apply the IATF 16949 standard.** The IATF certifications confirm our compliance with requirements regarding the quality management system in the automotive industry. Referring to customer requirements and customer specific requirements (“CSR”) TDK always has and will continue to have the policy of respecting individual agreements. Even if IATF 16949 may appear to support the acceptance of unilateral requirements, we hereby like to emphasize that **only requirements mutually agreed upon can and will be implemented in our Quality Management System.** For clarification purposes we like to point out that obligations from IATF 16949 shall only become legally binding if individually agreed upon.
8. The trade names EPCOS, CeraCharge, CeraDiode, CeraLink, CeraPad, CeraPlas, CSMP, CTVS, DeltaCap, DigiSiMic, ExoCore, FilterCap, FormFit, LeaXield, MiniBlue, MiniCell, MKD, MKK, MotorCap, PCC, PhaseCap, PhaseCube, PhaseMod, PhiCap, PowerHap, PQSine, PQvar, SIFERRIT, SIFI, SIKOREL, SilverCap, SIMDAD, SiMic, SIMID, SineFormer, SIOV, ThermoFuse, WindCap are **trademarks registered or pending** in Europe and in other countries. Further information will be found on the Internet at www.epcos.com/trademarks.

Release 2018-06