

Metallized Polypropylene Capacitors (MKP/MFP)

Series/Type: **B32612 ... B32614**

The following products presented in this data sheet are being withdrawn.

Ordering Code	Substitute Product	Date of Withdrawal	Deadline Last Orders	Last Shipments
B32612J1682K289		2015-07-24	2016-01-31	2016-07-31
B32612J1682K189		2015-07-24	2016-01-31	2016-07-31
B32612J1682K020		2015-07-24	2016-01-31	2016-07-31



Ordering Code	Substitute Product	Date of Withdrawal	Deadline Last Orders	Last Shipments
B32612J1682K010		2015-07-24	2016-01-31	2016-07-31
B32612J1682K008		2015-07-24	2016-01-31	2016-07-31
B32612J1682J289		2015-07-24	2016-01-31	2016-07-31
B32612J1682J189		2015-07-24	2016-01-31	2016-07-31
B32612J1682J020		2015-07-24	2016-01-31	2016-07-31
B32612J1682J010		2015-07-24	2016-01-31	2016-07-31
B32612J1682J008		2015-07-24	2016-01-31	2016-07-31
B32612J1472K289		2015-07-24	2016-01-31	2016-07-31
B32612J1472K189		2015-07-24	2016-01-31	2016-07-31
B32612J1472K020		2015-07-24	2016-01-31	2016-07-31
B32612J1472K010		2015-07-24	2016-01-31	2016-07-31
B32612J1472K008		2015-07-24	2016-01-31	2016-07-31
B32612J1472J289		2015-07-24	2016-01-31	2016-07-31
B32612J1472J189		2015-07-24	2016-01-31	2016-07-31
B32612J1472J020		2015-07-24	2016-01-31	2016-07-31
B32612J1472J010		2015-07-24	2016-01-31	2016-07-31
B32612J1472J008		2015-07-24	2016-01-31	2016-07-31
B32612J1332K289		2015-07-24	2016-01-31	2016-07-31
B32612J1332K189		2015-07-24	2016-01-31	2016-07-31
B32612J1332K020		2015-07-24	2016-01-31	2016-07-31
B32612J1332K010		2015-07-24	2016-01-31	2016-07-31
B32612J1332K008		2015-07-24	2016-01-31	2016-07-31
B32612J1332J289		2015-07-24	2016-01-31	2016-07-31
B32612J1332J189		2015-07-24	2016-01-31	2016-07-31
B32612J1332J020		2015-07-24	2016-01-31	2016-07-31
B32612J1332J010		2015-07-24	2016-01-31	2016-07-31
B32612J1332J008		2015-07-24	2016-01-31	2016-07-31
B32612J1103K289		2015-07-24	2016-01-31	2016-07-31
B32612J1103K189		2015-07-24	2016-01-31	2016-07-31
B32612J1103K020		2015-07-24	2016-01-31	2016-07-31
B32612J1103K010		2015-07-24	2016-01-31	2016-07-31
B32612J1103K008		2015-07-24	2016-01-31	2016-07-31
B32612J1103J289		2015-07-24	2016-01-31	2016-07-31
B32612J1103J189		2015-07-24	2016-01-31	2016-07-31
B32612J1103J020		2015-07-24	2016-01-31	2016-07-31
B32612J1103J010		2015-07-24	2016-01-31	2016-07-31
B32612J1103J008		2015-07-24	2016-01-31	2016-07-31
B32612A7682K289		2015-07-24	2016-01-31	2016-07-31



Ordering Code	Substitute Product	Date of Withdrawal	Deadline Last Orders	Last Shipments
B32612A7682K189		2015-07-24	2016-01-31	2016-07-31
B32612A7682K020		2015-07-24	2016-01-31	2016-07-31
B32612A7682K010		2015-07-24	2016-01-31	2016-07-31
B32612A7682K008		2015-07-24	2016-01-31	2016-07-31
B32612A7682J289		2015-07-24	2016-01-31	2016-07-31
B32612A7682J189		2015-07-24	2016-01-31	2016-07-31
B32612A7682J020		2015-07-24	2016-01-31	2016-07-31
B32612A7682J010		2015-07-24	2016-01-31	2016-07-31
B32612A7682J008		2015-07-24	2016-01-31	2016-07-31
B32612A7333K289		2015-07-24	2016-01-31	2016-07-31
B32612A7333K189		2015-07-24	2016-01-31	2016-07-31
B32612A7333K020		2015-07-24	2016-01-31	2016-07-31
B32612A7333K010		2015-07-24	2016-01-31	2016-07-31
B32612A7333K008		2015-07-24	2016-01-31	2016-07-31
B32612A7333J289		2015-07-24	2016-01-31	2016-07-31
B32612A7333J189		2015-07-24	2016-01-31	2016-07-31
B32612A7333J020		2015-07-24	2016-01-31	2016-07-31
B32612A7333J010		2015-07-24	2016-01-31	2016-07-31
B32612A7333J008		2015-07-24	2016-01-31	2016-07-31
B32612A7223K289		2015-07-24	2016-01-31	2016-07-31
B32612A7223K189		2015-07-24	2016-01-31	2016-07-31
B32612A7223K020		2015-07-24	2016-01-31	2016-07-31
B32612A7223K010		2015-07-24	2016-01-31	2016-07-31
B32612A7223K008		2015-07-24	2016-01-31	2016-07-31
B32612A7223J289		2015-07-24	2016-01-31	2016-07-31
B32612A7223J189		2015-07-24	2016-01-31	2016-07-31
B32612A7223J020		2015-07-24	2016-01-31	2016-07-31
B32612A7223J010		2015-07-24	2016-01-31	2016-07-31
B32612A7223J008		2015-07-24	2016-01-31	2016-07-31
B32612A7153K289		2015-07-24	2016-01-31	2016-07-31
B32612A7153K189		2015-07-24	2016-01-31	2016-07-31
B32612A7153K020		2015-07-24	2016-01-31	2016-07-31
B32612A7153K010		2015-07-24	2016-01-31	2016-07-31
B32612A7153K008		2015-07-24	2016-01-31	2016-07-31
B32612A7153J289		2015-07-24	2016-01-31	2016-07-31
B32612A7153J189		2015-07-24	2016-01-31	2016-07-31
B32612A7153J020		2015-07-24	2016-01-31	2016-07-31
B32612A7153J010		2015-07-24	2016-01-31	2016-07-31



Ordering Code	Substitute Product	Date of Withdrawal	Deadline Last Orders	Last Shipments
B32612A7153J008		2015-07-24	2016-01-31	2016-07-31
B32612A7103K289		2015-07-24	2016-01-31	2016-07-31
B32612A7103K189		2015-07-24	2016-01-31	2016-07-31
B32612A7103K020		2015-07-24	2016-01-31	2016-07-31
B32612A7103K010		2015-07-24	2016-01-31	2016-07-31
B32612A7103K008		2015-07-24	2016-01-31	2016-07-31
B32612A7103J289		2015-07-24	2016-01-31	2016-07-31
B32612A7103J189		2015-07-24	2016-01-31	2016-07-31
B32612A7103J020		2015-07-24	2016-01-31	2016-07-31
B32612A7103J010		2015-07-24	2016-01-31	2016-07-31
B32612A7103J008		2015-07-24	2016-01-31	2016-07-31
B32612A6683K289		2015-07-24	2016-01-31	2016-07-31
B32612A6683K189		2015-07-24	2016-01-31	2016-07-31
B32612A6683K020		2015-07-24	2016-01-31	2016-07-31
B32612A6683K010		2015-07-24	2016-01-31	2016-07-31
B32612A6683K008		2015-07-24	2016-01-31	2016-07-31
B32612A6683J289		2015-07-24	2016-01-31	2016-07-31
B32612A6683J189		2015-07-24	2016-01-31	2016-07-31
B32612A6683J020		2015-07-24	2016-01-31	2016-07-31
B32612A6683J010		2015-07-24	2016-01-31	2016-07-31
B32612A6683J008		2015-07-24	2016-01-31	2016-07-31
B32612A6224K289		2015-07-24	2016-01-31	2016-07-31
B32612A6224K189		2015-07-24	2016-01-31	2016-07-31
B32612A6224K020		2015-07-24	2016-01-31	2016-07-31
B32612A6224K010		2015-07-24	2016-01-31	2016-07-31
B32612A6224K008		2015-07-24	2016-01-31	2016-07-31
B32612A6224J289		2015-07-24	2016-01-31	2016-07-31
B32612A6224J189		2015-07-24	2016-01-31	2016-07-31
B32612A6224J020		2015-07-24	2016-01-31	2016-07-31
B32612A6224J010		2015-07-24	2016-01-31	2016-07-31
B32612A6224J008		2015-07-24	2016-01-31	2016-07-31
B32612A6154K289		2015-07-24	2016-01-31	2016-07-31
B32612A6154K189		2015-07-24	2016-01-31	2016-07-31
B32612A6154K020		2015-07-24	2016-01-31	2016-07-31
B32612A6154K010		2015-07-24	2016-01-31	2016-07-31
B32612A6154K008		2015-07-24	2016-01-31	2016-07-31
B32612A6154J289		2015-07-24	2016-01-31	2016-07-31
B32612A6154J189		2015-07-24	2016-01-31	2016-07-31



Ordering Code	Substitute Product	Date of Withdrawal	Deadline Last Orders	Last Shipments
B32612A6154J020		2015-07-24	2016-01-31	2016-07-31
B32612A6154J010		2015-07-24	2016-01-31	2016-07-31
B32612A6154J008		2015-07-24	2016-01-31	2016-07-31
B32612A6104K289		2015-07-24	2016-01-31	2016-07-31
B32612A6104K189		2015-07-24	2016-01-31	2016-07-31
B32612A6104K020		2015-07-24	2016-01-31	2016-07-31
B32612A6104K010		2015-07-24	2016-01-31	2016-07-31
B32612A6104K008		2015-07-24	2016-01-31	2016-07-31
B32612A6104J289		2015-07-24	2016-01-31	2016-07-31
B32612A6104J189		2015-07-24	2016-01-31	2016-07-31
B32612A6104J020		2015-07-24	2016-01-31	2016-07-31
B32612A6104J010		2015-07-24	2016-01-31	2016-07-31
B32612A6104J008		2015-07-24	2016-01-31	2016-07-31
B32612A4683K289		2015-07-24	2016-01-31	2016-07-31
B32612A4683K189		2015-07-24	2016-01-31	2016-07-31
B32612A4683K020		2015-07-24	2016-01-31	2016-07-31
B32612A4683K010		2015-07-24	2016-01-31	2016-07-31
B32612A4683K008		2015-07-24	2016-01-31	2016-07-31
B32612A4683J289		2015-07-24	2016-01-31	2016-07-31
B32612A4683J189		2015-07-24	2016-01-31	2016-07-31
B32612A4683J020		2015-07-24	2016-01-31	2016-07-31
B32612A4683J010		2015-07-24	2016-01-31	2016-07-31
B32612A4683J008		2015-07-24	2016-01-31	2016-07-31
B32612A4474K289		2015-07-24	2016-01-31	2016-07-31
B32612A4474K189		2015-07-24	2016-01-31	2016-07-31
B32612A4474K020		2015-07-24	2016-01-31	2016-07-31
B32612A4474K010		2015-07-24	2016-01-31	2016-07-31
B32612A4474K008		2015-07-24	2016-01-31	2016-07-31
B32612A4474J289		2015-07-24	2016-01-31	2016-07-31
B32612A4474J189		2015-07-24	2016-01-31	2016-07-31
B32612A4474J020		2015-07-24	2016-01-31	2016-07-31
B32612A4474J010		2015-07-24	2016-01-31	2016-07-31
B32612A4474J008		2015-07-24	2016-01-31	2016-07-31
B32612A4334K289		2015-07-24	2016-01-31	2016-07-31
B32612A4334K189		2015-07-24	2016-01-31	2016-07-31
B32612A4334K020		2015-07-24	2016-01-31	2016-07-31
B32612A4334K010		2015-07-24	2016-01-31	2016-07-31
B32612A4334K008		2015-07-24	2016-01-31	2016-07-31



Ordering Code	Substitute Product	Date of Withdrawal	Deadline Last Orders	Last Shipments
B32612A4334J289		2015-07-24	2016-01-31	2016-07-31
B32612A4334J189		2015-07-24	2016-01-31	2016-07-31
B32612A4334J020		2015-07-24	2016-01-31	2016-07-31
B32612A4334J010		2015-07-24	2016-01-31	2016-07-31
B32612A4334J008		2015-07-24	2016-01-31	2016-07-31
B32612A4224K289		2015-07-24	2016-01-31	2016-07-31
B32612A4224K189		2015-07-24	2016-01-31	2016-07-31
B32612A4224K020		2015-07-24	2016-01-31	2016-07-31
B32612A4224K010		2015-07-24	2016-01-31	2016-07-31
B32612A4224K008		2015-07-24	2016-01-31	2016-07-31
B32612A4224J289		2015-07-24	2016-01-31	2016-07-31
B32612A4224J189		2015-07-24	2016-01-31	2016-07-31
B32612A4224J020		2015-07-24	2016-01-31	2016-07-31
B32612A4224J010		2015-07-24	2016-01-31	2016-07-31
B32612A4224J008		2015-07-24	2016-01-31	2016-07-31
B32612A4154K289		2015-07-24	2016-01-31	2016-07-31
B32612A4154K189		2015-07-24	2016-01-31	2016-07-31
B32612A4154K020		2015-07-24	2016-01-31	2016-07-31
B32612A4154K010		2015-07-24	2016-01-31	2016-07-31
B32612A4154K008		2015-07-24	2016-01-31	2016-07-31
B32612A4154J289		2015-07-24	2016-01-31	2016-07-31
B32612A4154J189		2015-07-24	2016-01-31	2016-07-31
B32612A4154J020		2015-07-24	2016-01-31	2016-07-31
B32612A4154J010		2015-07-24	2016-01-31	2016-07-31
B32612A4154J008		2015-07-24	2016-01-31	2016-07-31
B32612A4104K289		2015-07-24	2016-01-31	2016-07-31
B32612A4104K189		2015-07-24	2016-01-31	2016-07-31
B32612A4104K020		2015-07-24	2016-01-31	2016-07-31
B32612A4104K010		2015-07-24	2016-01-31	2016-07-31
B32612A4104K008		2015-07-24	2016-01-31	2016-07-31
B32612A4104J289		2015-07-24	2016-01-31	2016-07-31
B32612A4104J189		2015-07-24	2016-01-31	2016-07-31
B32612A4104J020		2015-07-24	2016-01-31	2016-07-31
B32612A4104J010		2015-07-24	2016-01-31	2016-07-31
B32612A4104J008		2015-07-24	2016-01-31	2016-07-31
B32612A3684K289		2015-07-24	2016-01-31	2016-07-31
B32612A3684K189		2015-07-24	2016-01-31	2016-07-31
B32612A3684K020		2015-07-24	2016-01-31	2016-07-31



Ordering Code	Substitute Product	Date of Withdrawal	Deadline Last Orders	Last Shipments
B32612A3684K010		2015-07-24	2016-01-31	2016-07-31
B32612A3684K008		2015-07-24	2016-01-31	2016-07-31
B32612A3684J289		2015-07-24	2016-01-31	2016-07-31
B32612A3684J189		2015-07-24	2016-01-31	2016-07-31
B32612A3684J020		2015-07-24	2016-01-31	2016-07-31
B32612A3684J010		2015-07-24	2016-01-31	2016-07-31
B32612A3684J008		2015-07-24	2016-01-31	2016-07-31
B32612A3474K289		2015-07-24	2016-01-31	2016-07-31
B32612A3474K189		2015-07-24	2016-01-31	2016-07-31
B32612A3474K020		2015-07-24	2016-01-31	2016-07-31
B32612A3474K010		2015-07-24	2016-01-31	2016-07-31
B32612A3474K008		2015-07-24	2016-01-31	2016-07-31
B32612A3474J289		2015-07-24	2016-01-31	2016-07-31
B32612A3474J189		2015-07-24	2016-01-31	2016-07-31
B32612A3474J020		2015-07-24	2016-01-31	2016-07-31
B32612A3474J010		2015-07-24	2016-01-31	2016-07-31
B32612A3474J008		2015-07-24	2016-01-31	2016-07-31
B32612A3334K289		2015-07-24	2016-01-31	2016-07-31
B32612A3334K189		2015-07-24	2016-01-31	2016-07-31
B32612A3334K020		2015-07-24	2016-01-31	2016-07-31
B32612A3334K010		2015-07-24	2016-01-31	2016-07-31
B32612A3334K008		2015-07-24	2016-01-31	2016-07-31
B32612A3334J289		2015-07-24	2016-01-31	2016-07-31
B32612A3334J189		2015-07-24	2016-01-31	2016-07-31
B32612A3334J020		2015-07-24	2016-01-31	2016-07-31
B32612A3334J010		2015-07-24	2016-01-31	2016-07-31
B32612A3334J008		2015-07-24	2016-01-31	2016-07-31
B32612A3224K289		2015-07-24	2016-01-31	2016-07-31
B32612A3224K189		2015-07-24	2016-01-31	2016-07-31
B32612A3224K020		2015-07-24	2016-01-31	2016-07-31
B32612A3224K010		2015-07-24	2016-01-31	2016-07-31
B32612A3224K008		2015-07-24	2016-01-31	2016-07-31
B32612A3224J289		2015-07-24	2016-01-31	2016-07-31
B32612A3224J189		2015-07-24	2016-01-31	2016-07-31
B32612A3224J020		2015-07-24	2016-01-31	2016-07-31
B32612A3224J010		2015-07-24	2016-01-31	2016-07-31
B32612A3224J008		2015-07-24	2016-01-31	2016-07-31
B32612A3154K289		2015-07-24	2016-01-31	2016-07-31



Ordering Code	Substitute Product	Date of Withdrawal	Deadline Last Orders	Last Shipments
B32612A3154K189		2015-07-24	2016-01-31	2016-07-31
B32612A3154K020		2015-07-24	2016-01-31	2016-07-31
B32612A3154K010		2015-07-24	2016-01-31	2016-07-31
B32612A3154K008		2015-07-24	2016-01-31	2016-07-31
B32612A3154J289		2015-07-24	2016-01-31	2016-07-31
B32612A3154J189		2015-07-24	2016-01-31	2016-07-31
B32612A3154J020		2015-07-24	2016-01-31	2016-07-31
B32612A3154J010		2015-07-24	2016-01-31	2016-07-31
B32612A3154J008		2015-07-24	2016-01-31	2016-07-31
B32612A2472K289		2015-07-24	2016-01-31	2016-07-31
B32612A2472K189		2015-07-24	2016-01-31	2016-07-31
B32612A2472K020		2015-07-24	2016-01-31	2016-07-31
B32612A2472K010		2015-07-24	2016-01-31	2016-07-31
B32612A2472K008		2015-07-24	2016-01-31	2016-07-31
B32612A2472J289		2015-07-24	2016-01-31	2016-07-31
B32612A2472J189		2015-07-24	2016-01-31	2016-07-31
B32612A2472J020		2015-07-24	2016-01-31	2016-07-31
B32612A2472J010		2015-07-24	2016-01-31	2016-07-31
B32612A2472J008		2015-07-24	2016-01-31	2016-07-31
B32612A2332K289		2015-07-24	2016-01-31	2016-07-31
B32612A2332K189		2015-07-24	2016-01-31	2016-07-31
B32612A2332K020		2015-07-24	2016-01-31	2016-07-31
B32612A2332K010		2015-07-24	2016-01-31	2016-07-31
B32612A2332K008		2015-07-24	2016-01-31	2016-07-31
B32612A2332J289		2015-07-24	2016-01-31	2016-07-31
B32612A2332J189		2015-07-24	2016-01-31	2016-07-31
B32612A2332J020		2015-07-24	2016-01-31	2016-07-31
B32612A2332J010		2015-07-24	2016-01-31	2016-07-31
B32612A2332J008		2015-07-24	2016-01-31	2016-07-31
B32612A2222K289		2015-07-24	2016-01-31	2016-07-31
B32612A2222K189		2015-07-24	2016-01-31	2016-07-31
B32612A2222K020		2015-07-24	2016-01-31	2016-07-31
B32612A2222K010		2015-07-24	2016-01-31	2016-07-31
B32612A2222K008		2015-07-24	2016-01-31	2016-07-31
B32612A2222J289		2015-07-24	2016-01-31	2016-07-31
B32612A2222J189		2015-07-24	2016-01-31	2016-07-31
B32612A2222J020		2015-07-24	2016-01-31	2016-07-31
B32612A2222J010		2015-07-24	2016-01-31	2016-07-31



Ordering Code	Substitute Product	Date of Withdrawal	Deadline Last Orders	Last Shipments
B32612A2222J008		2015-07-24	2016-01-31	2016-07-31
B32612A2152K289		2015-07-24	2016-01-31	2016-07-31
B32612A2152K189		2015-07-24	2016-01-31	2016-07-31
B32612A2152K020		2015-07-24	2016-01-31	2016-07-31
B32612A2152K010		2015-07-24	2016-01-31	2016-07-31
B32612A2152K008		2015-07-24	2016-01-31	2016-07-31
B32612A2152J289		2015-07-24	2016-01-31	2016-07-31
B32612A2152J189		2015-07-24	2016-01-31	2016-07-31
B32612A2152J020		2015-07-24	2016-01-31	2016-07-31
B32612A2152J010		2015-07-24	2016-01-31	2016-07-31
B32612A2152J008		2015-07-24	2016-01-31	2016-07-31
B32612A2102K289		2015-07-24	2016-01-31	2016-07-31
B32612A2102K189		2015-07-24	2016-01-31	2016-07-31
B32612A2102K020		2015-07-24	2016-01-31	2016-07-31
B32612A2102K010		2015-07-24	2016-01-31	2016-07-31
B32612A2102K008		2015-07-24	2016-01-31	2016-07-31
B32612A2102J289		2015-07-24	2016-01-31	2016-07-31
B32612A2102J189		2015-07-24	2016-01-31	2016-07-31
B32612A2102J020		2015-07-24	2016-01-31	2016-07-31
B32612A2102J010		2015-07-24	2016-01-31	2016-07-31
B32612A2102J008		2015-07-24	2016-01-31	2016-07-31
B32612A1682K289		2015-07-24	2016-01-31	2016-07-31
B32612A1682K189		2015-07-24	2016-01-31	2016-07-31
B32612A1682K020		2015-07-24	2016-01-31	2016-07-31
B32612A1682K010		2015-07-24	2016-01-31	2016-07-31
B32612A1682K008		2015-07-24	2016-01-31	2016-07-31
B32612A1682J289		2015-07-24	2016-01-31	2016-07-31
B32612A1682J189		2015-07-24	2016-01-31	2016-07-31
B32612A1682J020		2015-07-24	2016-01-31	2016-07-31
B32612A1682J010		2015-07-24	2016-01-31	2016-07-31
B32612A1682J008		2015-07-24	2016-01-31	2016-07-31
B32612A1472K289		2015-07-24	2016-01-31	2016-07-31
B32612A1472K189		2015-07-24	2016-01-31	2016-07-31
B32612A1472K020		2015-07-24	2016-01-31	2016-07-31
B32612A1472K010		2015-07-24	2016-01-31	2016-07-31
B32612A1472K008		2015-07-24	2016-01-31	2016-07-31
B32612A1472J289		2015-07-24	2016-01-31	2016-07-31
B32612A1472J189		2015-07-24	2016-01-31	2016-07-31



Ordering Code	Substitute Product	Date of Withdrawal	Deadline Last Orders	Last Shipments
B32612A1472J020		2015-07-24	2016-01-31	2016-07-31
B32612A1472J010		2015-07-24	2016-01-31	2016-07-31
B32612A1472J008		2015-07-24	2016-01-31	2016-07-31
B32612A1153K289		2015-07-24	2016-01-31	2016-07-31
B32612A1153K189		2015-07-24	2016-01-31	2016-07-31
B32612A1153K020		2015-07-24	2016-01-31	2016-07-31
B32612A1153K010		2015-07-24	2016-01-31	2016-07-31
B32612A1153K008		2015-07-24	2016-01-31	2016-07-31
B32612A1153J289		2015-07-24	2016-01-31	2016-07-31
B32612A1153J189		2015-07-24	2016-01-31	2016-07-31
B32612A1153J020		2015-07-24	2016-01-31	2016-07-31
B32612A1153J010		2015-07-24	2016-01-31	2016-07-31
B32612A1153J008		2015-07-24	2016-01-31	2016-07-31
B32612A1103K289		2015-07-24	2016-01-31	2016-07-31
B32612A1103K189		2015-07-24	2016-01-31	2016-07-31
B32612A1103K020		2015-07-24	2016-01-31	2016-07-31
B32612A1103K010		2015-07-24	2016-01-31	2016-07-31
B32612A1103K008		2015-07-24	2016-01-31	2016-07-31
B32612A1103J289		2015-07-24	2016-01-31	2016-07-31
B32612A1103J189		2015-07-24	2016-01-31	2016-07-31
B32612A1103J020		2015-07-24	2016-01-31	2016-07-31
B32612A1103J010		2015-07-24	2016-01-31	2016-07-31
B32612A1103J008		2015-07-24	2016-01-31	2016-07-31
B32612A0683K289		2015-07-24	2016-01-31	2016-07-31
B32612A0683K189		2015-07-24	2016-01-31	2016-07-31
B32612A0683K020		2015-07-24	2016-01-31	2016-07-31
B32612A0683K010		2015-07-24	2016-01-31	2016-07-31
B32612A0683K008		2015-07-24	2016-01-31	2016-07-31
B32612A0683J289		2015-07-24	2016-01-31	2016-07-31
B32612A0683J189		2015-07-24	2016-01-31	2016-07-31
B32612A0683J020		2015-07-24	2016-01-31	2016-07-31
B32612A0683J010		2015-07-24	2016-01-31	2016-07-31
B32612A0683J008		2015-07-24	2016-01-31	2016-07-31
B32612A0473K289		2015-07-24	2016-01-31	2016-07-31
B32612A0473K189		2015-07-24	2016-01-31	2016-07-31
B32612A0473K020		2015-07-24	2016-01-31	2016-07-31
B32612A0473K010		2015-07-24	2016-01-31	2016-07-31
B32612A0473K008		2015-07-24	2016-01-31	2016-07-31



Ordering Code	Substitute Product	Date of Withdrawal	Deadline Last Orders	Last Shipments
B32612A0473J289		2015-07-24	2016-01-31	2016-07-31
B32612A0473J189		2015-07-24	2016-01-31	2016-07-31
B32612A0473J020		2015-07-24	2016-01-31	2016-07-31
B32612A0473J010		2015-07-24	2016-01-31	2016-07-31
B32612A0473J008		2015-07-24	2016-01-31	2016-07-31
B32612A0333K289		2015-07-24	2016-01-31	2016-07-31
B32612A0333K189		2015-07-24	2016-01-31	2016-07-31
B32612A0333K020		2015-07-24	2016-01-31	2016-07-31
B32612A0333K010		2015-07-24	2016-01-31	2016-07-31
B32612A0333K008		2015-07-24	2016-01-31	2016-07-31
B32612A0333J289		2015-07-24	2016-01-31	2016-07-31
B32612A0333J189		2015-07-24	2016-01-31	2016-07-31
B32612A0333J020		2015-07-24	2016-01-31	2016-07-31
B32612A0333J010		2015-07-24	2016-01-31	2016-07-31
B32612A0333J008		2015-07-24	2016-01-31	2016-07-31
B32612A0223K289		2015-07-24	2016-01-31	2016-07-31
B32612A0223K189		2015-07-24	2016-01-31	2016-07-31
B32612A0223K020		2015-07-24	2016-01-31	2016-07-31
B32612A0223K010		2015-07-24	2016-01-31	2016-07-31
B32612A0223K008		2015-07-24	2016-01-31	2016-07-31
B32612A0223J289		2015-07-24	2016-01-31	2016-07-31
B32612A0223J189		2015-07-24	2016-01-31	2016-07-31
B32612A0223J020		2015-07-24	2016-01-31	2016-07-31
B32612A0223J010		2015-07-24	2016-01-31	2016-07-31
B32612A0223J008		2015-07-24	2016-01-31	2016-07-31
B32612A0153K289		2015-07-24	2016-01-31	2016-07-31
B32612A0153K189		2015-07-24	2016-01-31	2016-07-31
B32612A0153K020		2015-07-24	2016-01-31	2016-07-31
B32612A0153K010		2015-07-24	2016-01-31	2016-07-31
B32612A0153K008		2015-07-24	2016-01-31	2016-07-31
B32612A0153J289		2015-07-24	2016-01-31	2016-07-31
B32612A0153J189		2015-07-24	2016-01-31	2016-07-31
B32612A0153J020		2015-07-24	2016-01-31	2016-07-31
B32612A0153J010		2015-07-24	2016-01-31	2016-07-31
B32612A0153J008		2015-07-24	2016-01-31	2016-07-31
B32612A0104K289		2015-07-24	2016-01-31	2016-07-31
B32612A0104K189		2015-07-24	2016-01-31	2016-07-31
B32612A0104K020		2015-07-24	2016-01-31	2016-07-31



Ordering Code	Substitute Product	Date of Withdrawal	Deadline Last Orders	Last Shipments
B32612A0104K010		2015-07-24	2016-01-31	2016-07-31
B32612A0104K008		2015-07-24	2016-01-31	2016-07-31
B32612A0104J289		2015-07-24	2016-01-31	2016-07-31
B32612A0104J189		2015-07-24	2016-01-31	2016-07-31
B32612A0104J020		2015-07-24	2016-01-31	2016-07-31
B32612A0104J010		2015-07-24	2016-01-31	2016-07-31
B32612A0104J008		2015-07-24	2016-01-31	2016-07-31
B32612A0103K289		2015-07-24	2016-01-31	2016-07-31
B32612A0103K189		2015-07-24	2016-01-31	2016-07-31
B32612A0103K020		2015-07-24	2016-01-31	2016-07-31
B32612A0103K010		2015-07-24	2016-01-31	2016-07-31
B32612A0103K008		2015-07-24	2016-01-31	2016-07-31
B32612A0103J289		2015-07-24	2016-01-31	2016-07-31
B32612A0103J189		2015-07-24	2016-01-31	2016-07-31
B32612A0103J020		2015-07-24	2016-01-31	2016-07-31
B32612A0103J010		2015-07-24	2016-01-31	2016-07-31
B32612A0103J008		2015-07-24	2016-01-31	2016-07-31

For further information please contact your nearest EPCOS sales office, which will also support you in selecting a suitable substitute. The addresses of our worldwide sales network are presented at www.epcos.com/sales.

High pulse (wound)**Typical applications**

- Electronic ballasts
- Switch-mode power supplies

Climatic

- Max. operating temperature: 110 °C
- Climatic category (IEC 60068-1): 55/100/56

Construction

- Dielectric: polypropylene (PP)
- Wound capacitor technology
- Epoxy resin coating (UL 94 V-0)

Features

- Very high pulse strength
- RoHS-compatible

Terminals

- Crimped wire leads, lead-free tinned, lead length (6 – 1) mm
- Double crimped wire leads, lead-free tinned
- Straight wire leads, lead-free tinned, lead length (17 ±3) mm
- Different lead spacings (reduced and enlarged) available, lead length (6 – 1) mm

Marking

Manufacturer's logo, style and type (P61x), rated capacitance (coded), capacitance tolerance (code letter), rated DC voltage, date of manufacture (code)

Delivery mode

Bulk (untaped)

Taped (Ammo pack or reel)

For notes on taping, refer to chapter "Taping and packing".

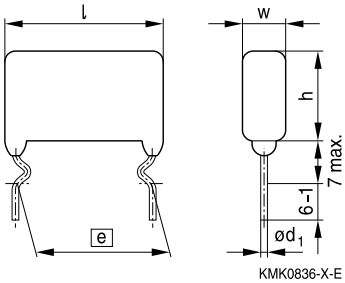
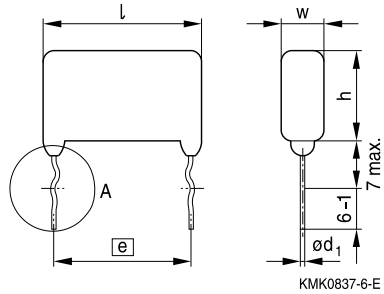
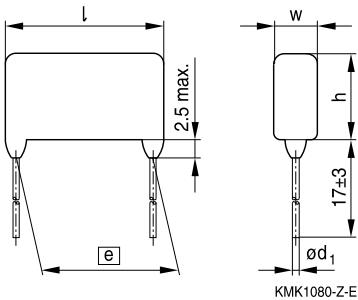
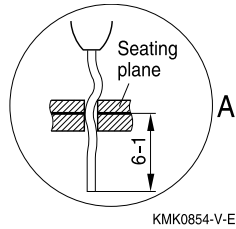
Dimensional drawings
Crimped leads

Double crimped leads

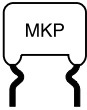
Straight leads

Detail of double crimped version

Dimensions in mm

Lead spacing	Lead diameter	Type
$e \pm 0.8$	d_1	
15.0	0.8	B32612
22.5	0.8	B32613
27.5	0.8	B32614



B32612 ... B32614

High pulse (wound)

Overview of available types

Lead spacing	15.0 mm							
Type	B32612							
Page	7							
V _R (V DC)	250	400	630	1000	1250	1600	1600	2000
V _{RMS} (V AC)	160	200	250	250	500	500	700	700
C _R (nF)								
1.0								
1.5								
2.2								
3.3								
4.7								
6.8								
10								
15								
22								
33								
47								
68								
100								
150								
220								
330								
470								
680								

Lead configurations

Serie	Standard	Reduced	Enlarged	Straight	Double crimped
B32612	15 mm	7.5 / 10 / 12.5 mm	17.5 mm	15 mm	15 mm
B32613	22.5 mm	15 / 17.5 / 20 mm	25 mm	22.5 mm	22.5 mm
B32614	27.5 mm	25 mm	–	27.5 mm	27.5 mm

Overview of available types

Lead spacing	22.5 mm						
Type	B32613						
Page	9						
V_R (V DC)	250	400	630	1000	1600	2000	2000
V_{RMS} (V AC)	160	200	250	250	500	700	1000
C_R (nF)							
3.3							
4.7							
6.8							
10							
15							
22							
33							
47							
68							
100							
150							
220							
330							
470							
680							
1000							

Lead configurations

Serie	Standard	Reduced	Enlarged	Straight	Double crimped
B32612	15 mm	7.5 / 10 / 12.5 mm	17.5 mm	15 mm	15 mm
B32613	22.5 mm	15 / 17.5 / 20 mm	25 mm	22.5 mm	22.5 mm
B32614	27.5 mm	25 mm	—	27.5 mm	27.5 mm

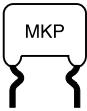

B32612 ... B32614

High pulse (wound)

Overview of available types

Lead spacing	27.5 mm					
Type	B32614					
Page	11					
V _R (V DC)	250	400	630	1000	1600	2000
V _{RMS} (V AC)	160	200	250	250	500	700
C _R (nF)						
10						
15						
22						
33						
47						
68						
100						
150						
220						
470						
680						
1000						
1500						
2200						

Lead configurations

Serie	Standard	Reduced	Enlarged	Straight	Double crimped
B32612	15 mm	7.5 / 10 / 12.5 mm	17.5 mm	15 mm	15 mm
B32613	22.5 mm	15 / 17.5 / 20 mm	25 mm	22.5 mm	22.5 mm
B32614	27.5 mm	25 mm	–	27.5 mm	27.5 mm

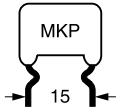
Ordering codes and packing units (lead spacing 15 mm)

V_R	V_{RMS} $f \leq 1$ kHz	C_R	Max. dimensions $w \times h \times l$ mm	Ordering code (composition see below)	Ammo pack pcs./MOQ	Reel pcs./ MOQ	Untaped pcs./ MOQ
V DC	V AC	nF					
250	160	150	6.5 × 12.5 × 18.0	B32612A3154+***	3400	4400	4000
		220	7.0 × 13.5 × 18.0	B32612A3224+***	3200	4000	4000
		330	8.0 × 14.5 × 18.0	B32612A3334+***	2800	3600	2000
		470	9.5 × 16.0 × 18.0	B32612A3474+***	2400	3200	2000
		680	11.5 × 17.5 × 18.0	B32612A3684+***	2000	2600	2000
400	200	68	6.5 × 12.0 × 18.0	B32612A4683+***	3400	4400	4000
		100	7.0 × 12.5 × 18.0	B32612A4104+***	3200	4000	4000
		150	7.5 × 12.5 × 18.0	B32612A4154+***	3000	4000	4000
		220	8.0 × 14.5 × 18.0	B32612A4224+***	2800	3600	2000
		330	9.5 × 16.0 × 18.0	B32612A4334+***	2400	3200	2000
		470	11.0 × 17.5 × 18.0	B32612A4474+***	2000	2600	2000
630	250	68	6.5 × 12.0 × 18.0	B32612A6683+***	3400	4400	4000
		100	7.5 × 13.0 × 18.0	B32612A6104+***	3000	4000	4000
		150	9.0 × 14.5 × 18.0	B32612A6154+***	2400	3200	2000
		220	10.0 × 16.5 × 18.0	B32612A6224+***	2200	3000	2000
1000	250	10	7.0 × 12.5 × 18.0	B32612A0103+***	3200	4000	4000
		15	8.0 × 13.5 × 18.0	B32612A0153+***	2800	3600	4000
		22	9.0 × 15.5 × 18.0	B32612A0223+***	2400	3200	4000
		33	6.5 × 13.0 × 18.0	B32612A0333+***	3400	4400	4000
		47	7.0 × 15.5 × 18.0	B32612A0473+***	3200	4000	4000
		68	8.5 × 16.5 × 18.0	B32612A0683+***	2600	3400	2000
		100	11.0 × 17.5 × 18.0	B32612A0104+***	2000	2600	2000

MOQ = Minimum Order Quantity, consisting of 4 packing units.
Further E series and intermediate capacitance values on request.

Composition of ordering code

+ = Capacitance tolerance code:

K = ±10%

J = ±5%

*** = Packaging code:

289 = Ammo pack

189 = Reel

010 = Untaped crimped (lead length 6 – 1 mm)

008 = Untaped straight (lead length 17±3 mm)

020 = Double crimped (lead length 6 – 1 mm)

Packaging codes for further lead configurations (untaped):

Lead configuration (lead length 6 – 1 mm)	Reduced	Reduced	Reduced	Enlarged
Lead spacing (mm)	7.5 mm	10 mm	12.5 mm	17.5 mm
Packaging code	030	040	050	060

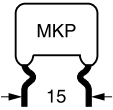
B32612
High pulse (wound)
Ordering codes and packing units (lead spacing 15 mm)

V_R	V_{RMS} $f \leq 1$ kHz	C_R	Max. dimensions $w \times h \times l$ mm	Ordering code (composition see below)	Ammo pack pcs./MOQ	Reel pcs./ MOQ	Untaped pcs./ MOQ
V DC	V AC	nF					
1250	500	6.8	7.0 × 11.0 × 18.0	B32612A7682+***	3200	4000	4000
		10	7.5 × 13.0 × 18.0	B32612A7103+***	3000	4000	4000
		15	8.0 × 14.0 × 18.0	B32612A7153+***	2800	3600	2000
		22	9.5 × 15.5 × 18.0	B32612A7223+***	2400	3200	2000
		33	11.0 × 17.5 × 18.0	B32612A7333+***	2000	2600	2000
1600	500	4.7	6.5 × 12.0 × 18.0	B32612A1472+***	3400	4400	4000
		6.8	8.0 × 13.0 × 18.0	B32612A1682+***	2800	3600	2000
		10	9.0 × 14.5 × 18.0	B32612A1103+***	2400	3200	2000
		15	10.0 × 17.5 × 18.0	B32612A1153+***	2200	3000	2000
1600	700	3.3	6.5 × 11.5 × 18.0	B32612J1332+***	3400	4400	4000
		4.7	7.5 × 12.5 × 18.0	B32612J1472+***	3000	4000	4000
		6.8	8.5 × 14.5 × 18.0	B32612J1682+***	2600	3400	2000
		10	9.5 × 17.0 × 18.0	B32612J1103+***	2400	3200	1000
2000	700	1.0	7.0 × 10.5 × 18.0	B32612A2102+***	3200	4000	4000
		1.5	7.5 × 11.5 × 18.0	B32612A2152+***	3000	4000	4000
		2.2	8.0 × 14.5 × 18.0	B32612A2222+***	2800	3600	4000
		3.3	8.5 × 15.0 × 18.0	B32612A2332+***	2600	3400	2000
		4.7	9.5 × 18.0 × 18.0	B32612A2472+***	2400	3200	2000

MOQ = Minimum Order Quantity, consisting of 4 packing units.
Further E series and intermediate capacitance values on request.

Composition of ordering code

+ = Capacitance tolerance code:

K = ±10%

J = ±5%

*** = Packaging code:

289 = Ammo pack

189 = Reel

010 = Untaped crimped (lead length 6 – 1 mm)

008 = Untaped straight (lead length 17±3 mm)

020 = Double crimped (lead length 6 – 1 mm)

Packaging codes for further lead configurations (untaped):

Lead configuration (lead length 6 – 1 mm)	Reduced	Reduced	Reduced	Enlarged
Lead spacing (mm)	7.5 mm	10 mm	12.5 mm	17.5 mm
Packaging code	030	040	050	060

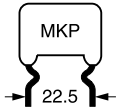
Ordering codes and packing units (lead spacing 22.5 mm)

V_R	V_{RMS} $f \leq 1$ kHz	C_R	Max. dimensions $w \times h \times l$ mm	Ordering code (composition see below)	Ammo pack pcs./MOQ	Reel pcs./ MOQ	Untaped pcs./ MOQ
V DC	V AC	nF					
250	160	220	7.0 × 14.5 × 26.5	B32613A3224+***	2000	2800	2000
		330	7.0 × 14.5 × 26.5	B32613A3334+***	2000	2800	2000
		470	8.0 × 15.5 × 26.5	B32613A3474+***	1800	2400	2000
		680	9.5 × 16.0 × 26.5	B32613A3684+***	1400	2000	2000
		1000	11.0 × 19.0 × 26.5	B32613A3105+***	1200	1800	1000
400	200	150	7.0 × 13.5 × 26.5	B32613A4154+***	2000	2800	2000
		220	7.0 × 14.0 × 26.5	B32613A4224+***	2000	2800	2000
		330	8.0 × 16.0 × 26.5	B32613A4334+***	1800	2400	2000
		470	9.5 × 16.0 × 26.5	B32613A4474+***	1400	2000	1000
		680	11.5 × 17.5 × 26.5	B32613A4684+***	1200	1600	1000
630	250	100	7.0 × 12.5 × 26.5	B32613A6104+***	2000	2800	1000
		150	7.5 × 14.0 × 26.5	B32613A6154+***	1800	2600	1000
		220	9.0 × 15.5 × 26.5	B32613A6224+***	1600	2200	1000
		330	10.0 × 18.0 × 26.5	B32613A6334+***	1400	2000	1000
		470	11.0 × 20.0 × 26.5	B32613A6474+***	1200	1800	1000
1000	250	33	8.5 × 14.5 × 26.5	B32613A0333+***	1600	2200	2000
		47	10.0 × 15.5 × 26.5	B32613A0473+***	1400	2000	1000
		68	11.0 × 17.5 × 26.5	B32613A0683+***	1200	1800	1000
		100	10.0 × 16.5 × 26.5	B32613A0104+***	1400	2000	1000
		150	12.0 × 18.0 × 26.5	B32613A0154+***	1200	1600	1000

MOQ = Minimum Order Quantity, consisting of 4 packing units.

Further E series and intermediate capacitance values on request.

Composition of ordering code

+ = Capacitance tolerance code:

K = ±10%

J = ±5%

*** = Packaging code:

289 = Ammo pack

189 = Reel

010 = Untaped crimped (lead length 6 – 1 mm)

008 = Untaped straight (lead length 17±3 mm)

020 = Double crimped (lead length 6 – 1 mm)

Packaging codes for further lead configurations (untaped):

Lead configuration (lead length 6 – 1 mm)	Reduced	Reduced	Reduced	Enlarged
Lead spacing (mm)	15 mm	17.5 mm	20 mm	25 mm
Packaging code	055	060	070	080

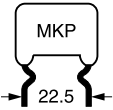
B32613
High pulse (wound)
Ordering codes and packing units (lead spacing 22.5 mm)

V_R	V_{RMS} $f \leq 1$ kHz	C_R	Max. dimensions $w \times h \times l$ mm	Ordering code (composition see below)	Ammo pack pcs./MOQ	Reel pcs./ MOQ	Untaped pcs./ MOQ
V DC	V AC	nF					
1600	500	10	7.0 × 13.5 × 26.5	B32613A1103+***	2000	2800	2000
		15	8.0 × 14.5 × 26.5	B32613A1153+***	1800	2400	2000
		22	9.0 × 17.0 × 26.5	B32613A1223+***	1600	2200	1000
		33	10.5 × 18.5 × 26.5	B32613A1333+***	1400	1800	1000
2000	700	3.3	7.0 × 13.0 × 26.5	B32613A2332+***	2000	2800	2000
		4.7	7.5 × 14.0 × 26.5	B32613A2472+***	1800	2600	2000
		6.8	8.5 × 16.0 × 26.5	B32613A2682+***	1600	2200	2000
		10	10.5 × 17.0 × 26.5	B32613A2103+***	1400	1800	1000
		15	12.0 × 20.5 × 26.5	B32613A2153+***	1200	1600	1000
2000	1000	3.3	8.0 × 14.5 × 26.5	B32613A8332+***	1800	2400	2000
		4.7	8.5 × 16.5 × 26.5	B32613A8472+***	1600	2200	1000
		6.8	10.0 × 18.5 × 26.5	B32613A8682+***	1400	2000	1000
		10	11.5 × 21.5 × 26.5	B32613A8103+***	1200	1600	1000

MOQ = Minimum Order Quantity, consisting of 4 packing units.

Further E series and intermediate capacitance values on request.

Composition of ordering code

+ = Capacitance tolerance code:

K = ±10%

J = ±5%

*** = Packaging code:

289 = Ammo pack

189 = Reel

010 = Untaped crimped (lead length 6 – 1 mm)

008 = Untaped straight (lead length 17±3 mm)

020 = Double crimped (lead length 6 – 1 mm)

Packaging codes for further lead configurations (untaped):

Lead configuration (lead length 6 – 1 mm)	Reduced	Reduced	Reduced	Enlarged
Lead spacing (mm)	15 mm	17.5 mm	20 mm	25 mm
Packaging code	055	060	070	080

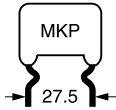
Ordering codes and packing units (lead spacing 27.5 mm)

V_R	V_{RMS} $f \leq 1 \text{ kHz}$	C_R	Max. dimensions $w \times h \times l$	Ordering code (composition see below)	Untaped pcs./MOQ
V DC	V AC	nF	mm		
250	160	470	7.0 × 15.0 × 31.5	B32614A3474+***	2000
		680	8.0 × 16.5 × 31.5	B32614A3684+***	2000
		1000	9.5 × 17.5 × 31.5	B32614A3105+***	800
		1500	11.5 × 19.5 × 31.5	B32614A3155+***	800
		2200	14.0 × 22.0 × 31.5	B32614A3225+***	800
400	200	470	9.5 × 15.0 × 31.5	B32614A4474+***	800
		680	10.0 × 17.5 × 31.5	B32614A4684+***	800
		1000	11.5 × 19.5 × 31.5	B32614A4105+***	800
		1500	14.0 × 22.0 × 31.5	B32614A4155+***	800
		2200	16.5 × 24.5 × 31.5	B32614A4225+***	600
630	250	470	10.5 × 18.5 × 31.5	B32614A6474+***	800
		680	12.0 × 21.5 × 31.5	B32614A6684+***	800
		1000	14.0 × 24.0 × 31.5	B32614A6105+***	800
1000	250	100	11.5 × 17.5 × 31.5	B32614A0104+***	2000
		150	13.0 × 21.0 × 31.5	B32614A0154+***	800
		220	14.5 × 24.5 × 31.5	B32614A0224+***	800
1600	500	22	9.0 × 14.5 × 31.5	B32614A1223+***	2000
		33	10.5 × 16.0 × 31.5	B32614A1333+***	2000
		47	11.0 × 19.5 × 31.5	B32614A1473+***	800
		68	13.0 × 21.5 × 31.5	B32614A1683+***	800
2000	700	10	9.0 × 15.5 × 31.5	B32614A2103+***	2000
		15	11.0 × 17.5 × 31.5	B32614A2153+***	800
		22	13.0 × 19.5 × 31.5	B32614A2223+***	800
		33	14.5 × 23.0 × 31.5	B32614A2333+***	800
		47	16.5 × 25.5 × 31.5	B32614A2473+***	600

MOQ = Minimum Order Quantity, consisting of 4 packing units.
Further E series and intermediate capacitance values on request.

Composition of ordering code

+ = Capacitance tolerance code:

K = ±10%

J = ±5%

*** = Packaging code:

010 = Untaped crimped (lead length 6 – 1 mm)

008 = Untaped straight (lead length 17±3 mm)

020 = Double crimped (lead length 6 – 1 mm)

Packaging codes for further lead configurations (untaped):

Lead configuration (lead length 6 – 1 mm)	Reduced
Lead spacing (mm)	25 mm
Packaging code	090

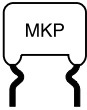

B32612 ... B32614
High pulse (wound)
Technical data

Operating temperature range	Max. operating temperature $T_{op,max}$			+110 °C
	Upper category temperature T_{max}			+100 °C
	Lower category temperature T_{min}			-55 °C
	Rated temperature T_R			+85 °C
Dissipation factor $\tan \delta$ (in 10^{-3}) at 20 °C (upper limit values)	at	$C_R \leq 0.1 \mu F$	$0.1 \mu F < C_R \leq 1 \mu F$	$C_R > 1 \mu F$
	1 kHz	–	0.5	0.5
	10 kHz	–	0.8	1.5
	100 kHz	5.0	–	–
Insulation resistance R_{ins} or time constant $\tau = C_R \cdot R_{ins}$ at 20 °C, rel. humidity $\leq 65\%$ (minimum as-delivered values)	$C_R \leq 0.33 \mu F$		$C_R > 0.33 \mu F$	
	100 G Ω		30000 s	
DC test voltage	$1.6 \cdot V_R, 2 s$			
Category voltage V_C (continuous operation with V_{DC} or V_{AC} at $f \leq 1 kHz$)	T_A (°C)	DC voltage derating	AC voltage derating	
	$T_A \leq 85$ $85 < T_A \leq 100$	$V_C = V_R$ $V_C = V_R \cdot (165 - T_A) / 80$	$V_{C,RMS} = V_{RMS}$ $V_{C,RMS} = V_{RMS} \cdot (165 - T_A) / 80$	
Operating voltage V_{op} for short operating periods (V_{DC} or V_{AC} at $f \leq 1 kHz$)	T_A (°C)	DC voltage (max. hours)	AC voltage (max. hours)	
	$T_A \leq 100$ $100 < T_A \leq 110$	$V_{op} = 1.25 \cdot V_C$ (2000 h) $V_{op} = 1.25 \cdot V_C$ (1000 h)	$V_{op} = 1.0 \cdot V_{C,RMS}$ (2000 h) $V_{op} = 1.0 \cdot V_{C,RMS}$ (1000 h)	
Damp heat test Limit values after damp heat test	56 days/40 °C/93% relative humidity			
	Capacitance change $ \Delta C/C $		$\leq 3\%$	
	Dissipation factor change $\Delta \tan \delta$		$\leq 0.5 \cdot 10^{-3}$ (at 1 kHz) $\leq 1.0 \cdot 10^{-3}$ (at 10 kHz)	
	Insulation resistance R_{ins} or time constant $\tau = C_R \cdot R_{ins}$		$\geq 50\%$ of minimum as-delivered values	
Reliability: Failure rate λ Service life t_{SL}	1 fit ($\leq 1 \cdot 10^{-9}$ /h) at $0.5 \cdot V_R, 40$ °C 200 000 h at $1.0 \cdot V_R, 85$ °C For conversion to other operating conditions and temperatures, refer to chapter "Quality, 2 Reliability".			
Failure criteria: Total failure Failure due to variation of parameters	Short circuit or open circuit			
	Capacitance change $ \Delta C/C $		$> 10\%$	
	Dissipation factor $\tan \delta$		$> 4 \cdot$ upper limit value	
	Insulation resistance R_{ins} or time constant $\tau = C_R \cdot R_{ins}$		$< 1500 M\Omega$ ($C_R \leq 0.33 \mu F$) $< 500 s$ ($C_R > 0.33 \mu F$)	

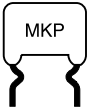

Characteristic voltages V_{DC} , V_{AC} , V_{pp}

V_{DC} V	V_{AC} V	V_{pp} V
1000	250	700
1250	500	1250
1600	500	1400
1600	700	1600
2000	700	1600
2000	1000	2000



B32612 ... B32614

High pulse (wound)

Pulse handling capability

"dV/dt" represents the maximum permissible voltage change per unit of time for non-sinusoidal voltages, expressed in V/ μ s.

"k₀" represents the maximum permissible pulse characteristic of the waveform applied to the capacitor, expressed in V²/ μ s.

Note:

The values of dV/dt and k₀ provided below must not be exceeded in order to avoid damaging the capacitor.

dV/dt values

Lead spacing		15 mm	22.5 mm	27.5 mm
V _R V DC	V _{RMS} V AC	dV/dt in V/ μ s		
250	160	200	120	50
400	200	300	180	100
630	250	400	300	150
1000	250	975	600	300
1250	500	1850	1150	600
1600	500	4500	2400	1000
1600	700	5200	—	—
2000	700	8000	7000	2300
2000	1000	—	7500	—

k₀ values

Lead spacing		15 mm	22.5 mm	27.5 mm
V _R V DC	V _{RMS} V AC	k ₀ in V ² / μ s		
250	160	100 000	60 000	25 000
400	200	250 000	200 000	110 000
630	250	500 000	350 000	250 000
1000	250	3 000 000	1 500 000	1 000 000
1250	500	9 000 000	3 750 000	2 000 000
1600	500	20 000 000	10 000 000	4 000 000
1600	700	28 000 000	—	—
2000	700	60 000 000	40 000 000	15 000 000
2000	1000	—	50 000 000	—

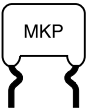

Impedance Z versus frequency f
(typical values)

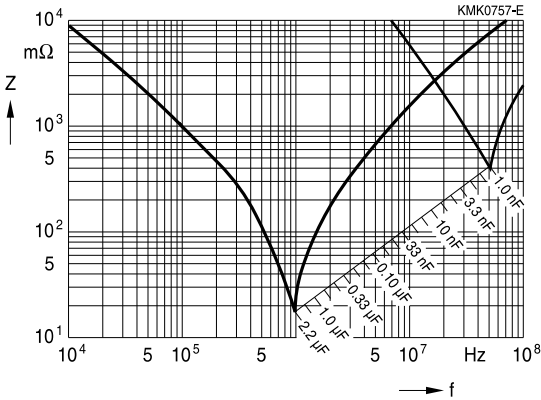

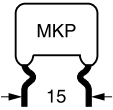

B32612

High pulse (wound)

Permissible AC voltage V_{RMS} versus frequency f (for sinusoidal waveforms, $T_A \leq 90^\circ C$)

For $T_A > 90^\circ C$, please refer to "General technical information", section 3.2.3.

Lead spacing 15 mm

250 V DC/160 V AC

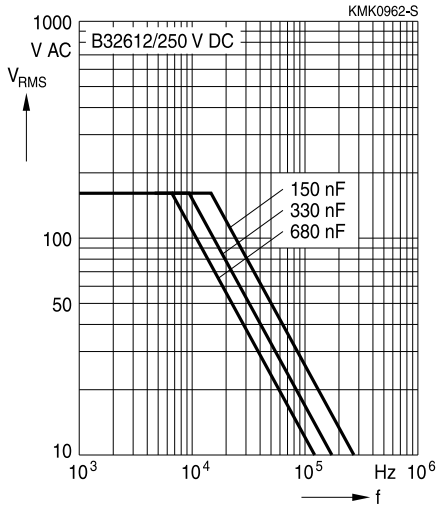

400 V DC/200 V AC

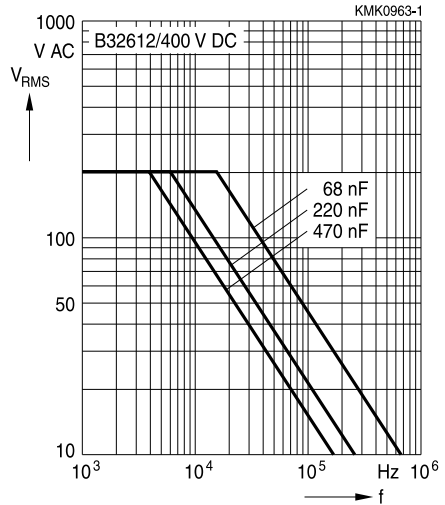

630 V DC/250 V AC

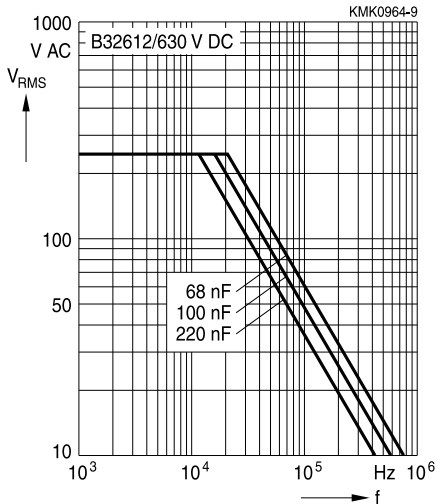

1000 V DC/250 V AC

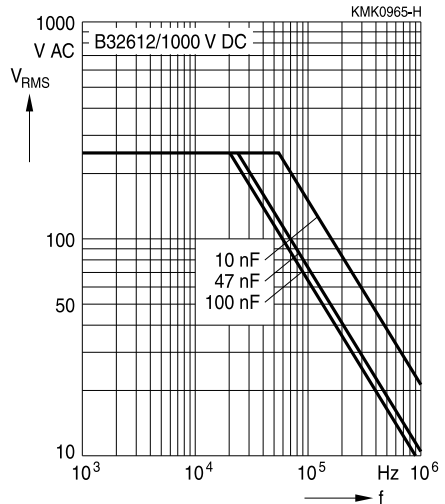

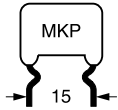

Permissible AC voltage V_{RMS} versus frequency f (for sinusoidal waveforms, $T_A \leq 90^\circ C$)

For $T_A > 90^\circ C$, please refer to "General technical information", section 3.2.3.

Lead spacing 15 mm

1250 V DC/500 V AC

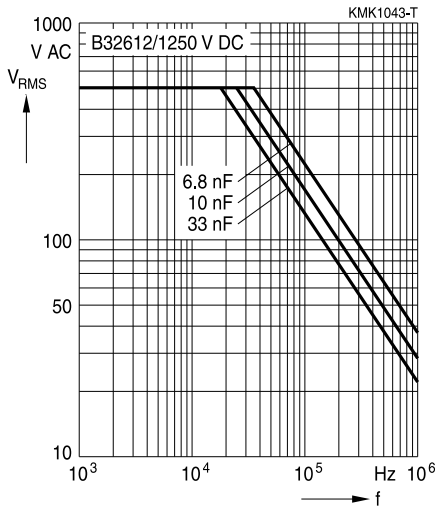

1600 V DC/500 V AC

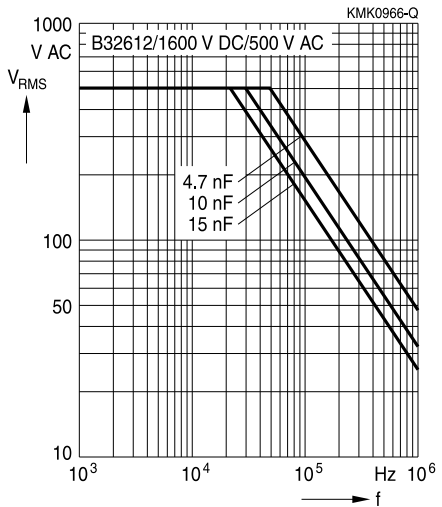

1600 V DC/700 V AC

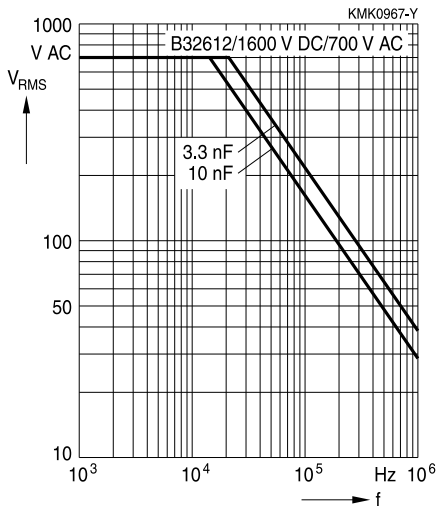

2000 V DC/700 V AC

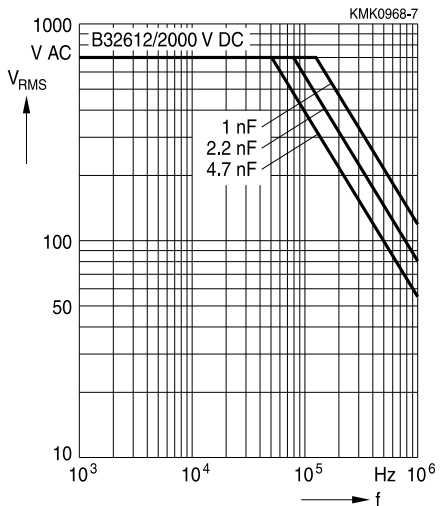

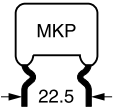

B32613

High pulse (wound)

Permissible AC voltage V_{RMS} versus frequency f (for sinusoidal waveforms, $T_A \leq 90^\circ C$)

For $T_A > 90^\circ C$, please refer to "General technical information", section 3.2.3.

Lead spacing 22.5 mm

250 V DC/160 V AC

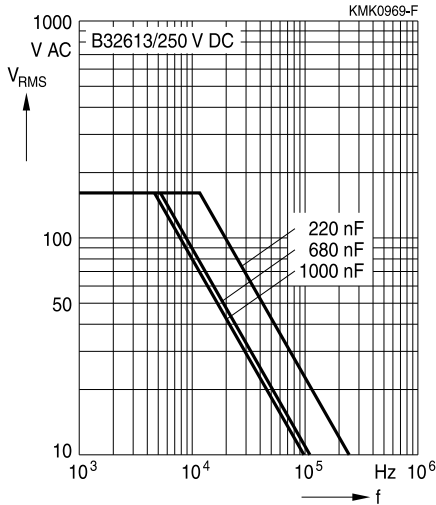

400 V DC/200 V AC

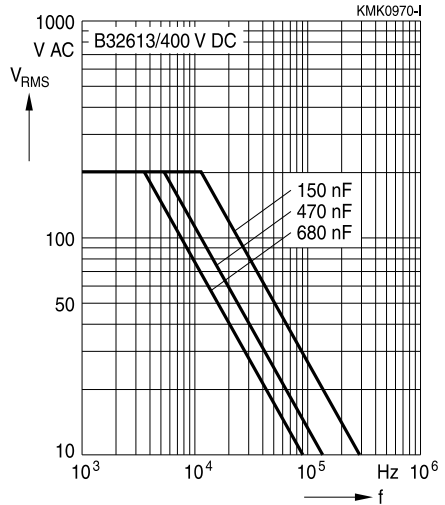

630 V DC/250 V AC

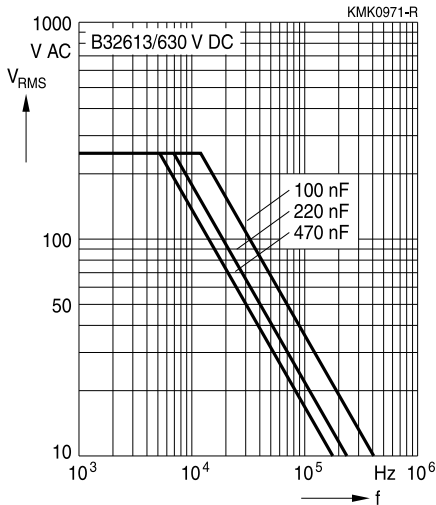

1000 V DC/250 V AC

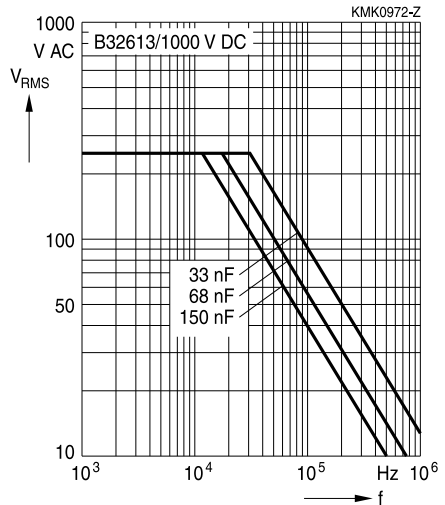

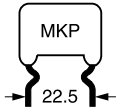

Permissible AC voltage V_{RMS} versus frequency f (for sinusoidal waveforms, $T_A \leq 90^\circ C$)

For $T_A > 90^\circ C$, please refer to "General technical information", section 3.2.3.

Lead spacing 22.5 mm

1600 V DC/500 V AC

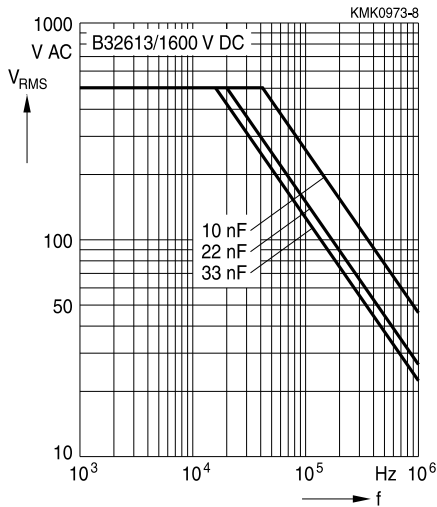

2000 V DC/700 V AC

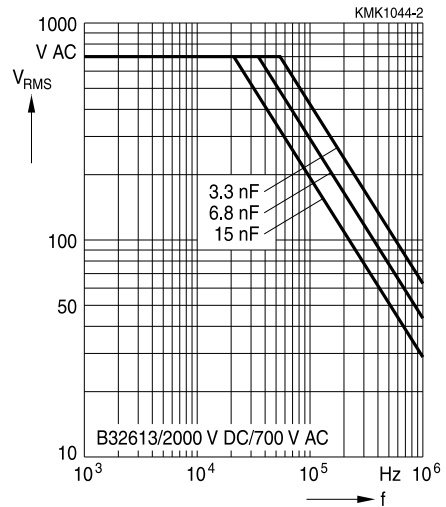

2000 V DC/1000 V AC

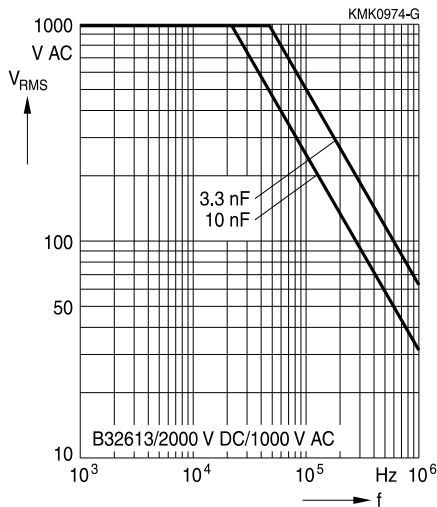

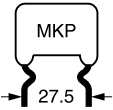

B32614

High pulse (wound)

Permissible AC voltage V_{RMS} versus frequency f (for sinusoidal waveforms, $T_A \leq 90^\circ C$)

For $T_A > 90^\circ C$, please refer to "General technical information", section 3.2.3.

Lead spacing 27.5 mm

250 V DC/160 V AC

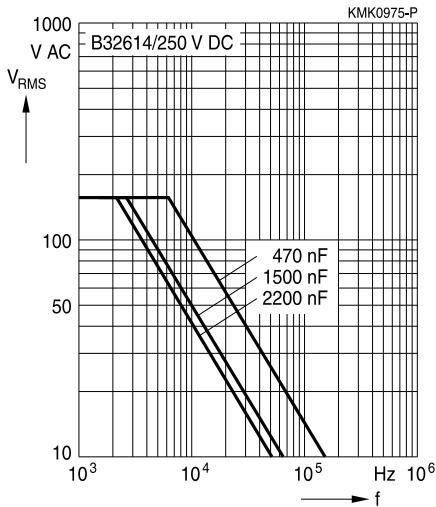

400 V DC/200 V AC

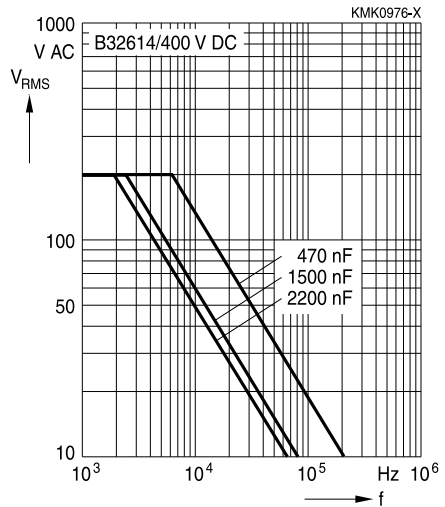

630 V DC/250 V AC

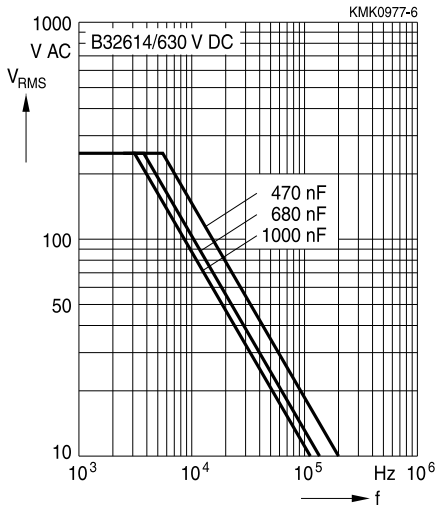

1000 V DC/250 V AC

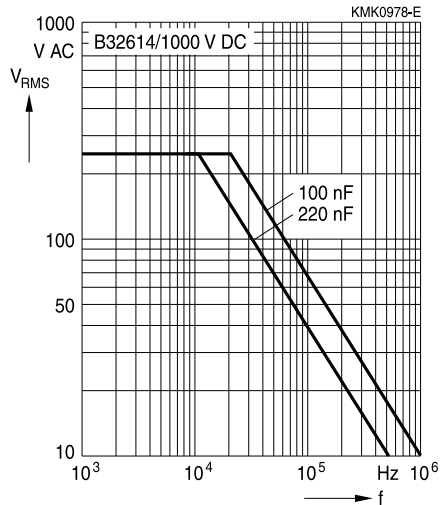

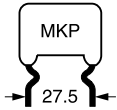

Permissible AC voltage V_{RMS} versus frequency f (for sinusoidal waveforms, $T_A \leq 90^\circ C$)

For $T_A > 90^\circ C$, please refer to "General technical information", section 3.2.3.

Lead spacing 27.5 mm

1600 V DC/500 V AC

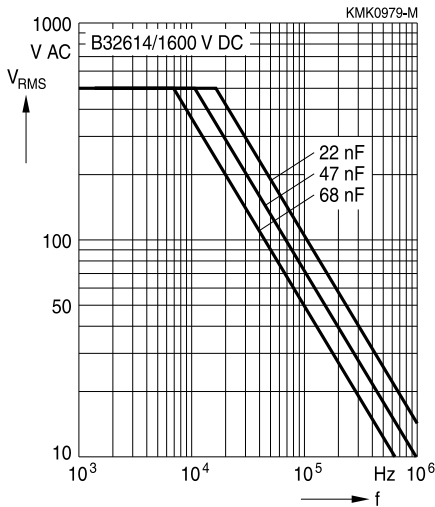

2000 V DC/700 V AC

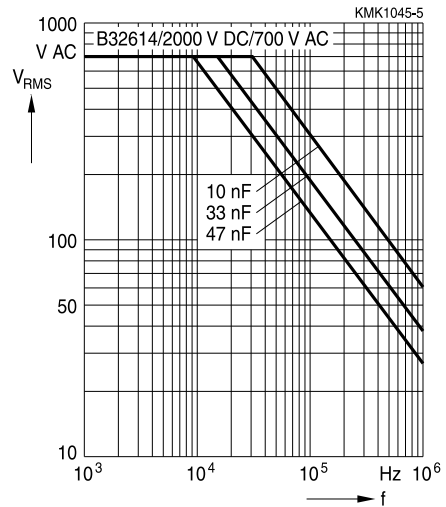

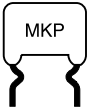

B32612 ... B32614

High pulse (wound)

Mounting guidelines

1 Soldering

1.1 Solderability of leads

The solderability of terminal leads is tested to IEC 60068-2-20, test Ta, method 1.

Before a solderability test is carried out, terminals are subjected to accelerated ageing (to IEC 60068-2-2, test Ba: 4 h exposure to dry heat at 155 °C). Since the ageing temperature is far higher than the upper category temperature of the capacitors, the terminal wires should be cut off from the capacitor before the ageing procedure to prevent the solderability being impaired by the products of any capacitor decomposition that might occur.

Solder bath temperature	235 ±5 °C
Soldering time	2.0 ±0.5 s
Immersion depth	2.0 +0/-0.5 mm from capacitor body or seating plane
Evaluation criteria: Visual inspection	Wetting of wire surface by new solder ≥90%, free-flowing solder

1.2 Resistance to soldering heat

Resistance to soldering heat is tested to IEC 60068-2-20, test Tb, method 1A.

Conditions:

Series	Solder bath temperature	Soldering time
MKT boxed (except 2.5 × 6.5 × 7.2 mm) coated uncoated (lead spacing > 10 mm)	260 ±5 °C	10 ±1 s
MFP MKP (lead spacing > 7.5 mm)		
MKT boxed (case 2.5 × 6.5 × 7.2 mm)	260 ±5 °C	5 ±1 s
MKP (lead spacing ≤ 7.5 mm)		< 4 s
MKT uncoated (lead spacing ≤ 10 mm) insulated (B32559)		recommended soldering profile for MKT uncoated (lead spacing ≤ 10 mm) and insulated (B32559)

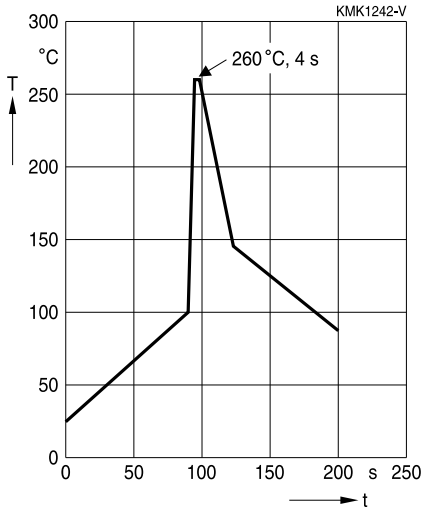
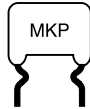

Immersion depth	2.0 +0/−0.5 mm from capacitor body or seating plane
Shield	Heat-absorbing board, (1.5 ±0.5) mm thick, between capacitor body and liquid solder
Evaluation criteria:	
Visual inspection	No visible damage
$\Delta C/C_0$	2% for MKT/MKP/MFP 5% for EMI suppression capacitors
$\tan \delta$	As specified in sectional specification



B32612 ... B32614

High pulse (wound)

1.3 General notes on soldering

Permissible heat exposure loads on film capacitors are primarily characterized by the upper category temperature T_{max} . Long exposure to temperatures above this type-related temperature limit can lead to changes in the plastic dielectric and thus change irreversibly a capacitor's electrical characteristics. For short exposures (as in practical soldering processes) the heat load (and thus the possible effects on a capacitor) will also depend on other factors like:

- Pre-heating temperature and time
- Forced cooling immediately after soldering
- Terminal characteristics:
diameter, length, thermal resistance, special configurations (e.g. crimping)
- Height of capacitor above solder bath
- Shadowing by neighboring components
- Additional heating due to heat dissipation by neighboring components
- Use of solder-resist coatings

The overheating associated with some of these factors can usually be reduced by suitable countermeasures. For example, if a pre-heating step cannot be avoided, an additional or reinforced cooling process may possibly have to be included.

EPCOS recommends the following conditions:

- Pre-heating with a maximum temperature of 110 °C
- Temperature inside the capacitor should not exceed the following limits:
 - MKP/MFP 110 °C
 - MKT 160 °C
- When SMD components are used together with leaded ones, the leaded film capacitors should not pass into the SMD adhesive curing oven. The leaded components should be assembled after the SMD curing step.
- Leaded film capacitors are not suitable for reflow soldering.

Uncoated capacitors

For uncoated MKT capacitors with lead spacings ≤ 10 mm (B32560/B32561) the following measures are recommended:

- pre-heating to not more than 110 °C in the preheater phase
- rapid cooling after soldering



Cautions and warnings

- Do not exceed the upper category temperature (UCT).
- Do not apply any mechanical stress to the capacitor terminals.
- Avoid any compressive, tensile or flexural stress.
- Do not move the capacitor after it has been soldered to the PC board.
- Do not pick up the PC board by the soldered capacitor.
- Do not place the capacitor on a PC board whose PTH hole spacing differs from the specified lead spacing.
- Do not exceed the specified time or temperature limits during soldering.
- Avoid external energy inputs, such as fire or electricity.
- Avoid overload of the capacitors.

The table below summarizes the safety instructions that must always be observed. A detailed description can be found in the relevant sections of the chapters "General technical information" and "Mounting guidelines".

Topic	Safety information	Reference chapter "General technical information"
Storage conditions	Make sure that capacitors are stored within the specified range of time, temperature and humidity conditions.	4.5 "Storage conditions"
Flammability	Avoid external energy, such as fire or electricity (passive flammability), avoid overload of the capacitors (active flammability) and consider the flammability of materials.	5.3 "Flammability"
Resistance to vibration	Do not exceed the tested ability to withstand vibration. The capacitors are tested to IEC 60068-2-6. EPCOS offers film capacitors specially designed for operation under more severe vibration regimes such as those found in automotive applications. Consult our catalog "Film Capacitors for Automotive Electronics".	5.2 "Resistance to vibration"



B32612 ... B32614

High pulse (wound)

Topic	Safety information	Reference chapter "Mounting guidelines"
Soldering	Do not exceed the specified time or temperature limits during soldering.	1 "Soldering"
Cleaning	Use only suitable solvents for cleaning capacitors.	2 "Cleaning"
Embedding of capacitors in finished assemblies	When embedding finished circuit assemblies in plastic resins, chemical and thermal influences must be taken into account. Caution: Consult us first, if you also wish to embed other uncoated component types!	3 "Embedding of capacitors in finished assemblies"

Symbols and terms

Symbol	English	German
α	Heat transfer coefficient	Wärmeübergangszahl
α_C	Temperature coefficient of capacitance	Temperaturkoeffizient der Kapazität
A	Capacitor surface area	Kondensatoroberfläche
β_C	Humidity coefficient of capacitance	Feuchtekoeffizient der Kapazität
C	Capacitance	Kapazität
C_R	Rated capacitance	Nennkapazität
ΔC	Absolute capacitance change	Absolute Kapazitätsänderung
$\Delta C/C$	Relative capacitance change (relative deviation of actual value)	Relative Kapazitätsänderung (relative Abweichung vom Ist-Wert)
$\Delta C/C_R$	Capacitance tolerance (relative deviation from rated capacitance)	Kapazitätstoleranz (relative Abweichung vom Nennwert)
dt	Time differential	Differentielle Zeit
Δt	Time interval	Zeitintervall
ΔT	Absolute temperature change (self-heating)	Absolute Temperaturänderung (Selbsterwärmung)
$\Delta \tan \delta$	Absolute change of dissipation factor	Absolute Änderung des Verlustfaktors
ΔV	Absolute voltage change	Absolute Spannungsänderung
dV/dt	Time differential of voltage function (rate of voltage rise)	Differentielle Spannungsänderung (Spannungsflankensteilheit)
$\Delta V/\Delta t$	Voltage change per time interval	Spannungsänderung pro Zeitintervall
E	Activation energy for diffusion	Aktivierungsenergie zur Diffusion
ESL	Self-inductance	Eigeninduktivität
ESR	Equivalent series resistance	Ersatz-Serienwiderstand
f	Frequency	Frequenz
f_1	Frequency limit for reducing permissible AC voltage due to thermal limits	Grenzfrequenz für thermisch bedingte Reduzierung der zulässigen Wechselspannung
f_2	Frequency limit for reducing permissible AC voltage due to current limit	Grenzfrequenz für strombedingte Reduzierung der zulässigen Wechselspannung
f_r	Resonant frequency	Resonanzfrequenz
F_D	Thermal acceleration factor for diffusion	Therm. Beschleunigungsfaktor zur Diffusion
F_T	Derating factor	Deratingfaktor
i	Current (peak)	Stromspitze
I_C	Category current (max. continuous current)	Kategoriestrom (max. Dauerstrom)

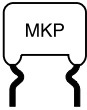

B32612 ... B32614

High pulse (wound)

Symbol	English	German
I_{RMS}	(Sinusoidal) alternating current, root-mean-square value	(Sinusförmiger) Wechselstrom
i_z	Capacitance drift	Inkonstanz der Kapazität
k_0	Pulse characteristic	Impuls Kennwert
L_S	Series inductance	Serieninduktivität
λ	Failure rate	Ausfallrate
λ_0	Constant failure rate during useful service life	Konstante Ausfallrate in der Nutzungsphase
λ_{test}	Failure rate, determined by tests	Experimentell ermittelte Ausfallrate
P_{diss}	Dissipated power	Abgegebene Verlustleistung
P_{gen}	Generated power	Erzeugte Verlustleistung
Q	Heat energy	Wärmeenergie
ρ	Density of water vapor in air	Dichte von Wasserdampf in Luft
R	Universal molar constant for gases	Allg. Molarkonstante für Gas
R	Ohmic resistance of discharge circuit	Ohmscher Widerstand des Entladekreises
R_i	Internal resistance	Innenwiderstand
R_{ins}	Insulation resistance	Isolationswiderstand
R_P	Parallel resistance	Parallelwiderstand
R_S	Series resistance	Serienwiderstand
S	severity (humidity test)	Schärfegrad (Feuchtest)
t	Time	Zeit
T	Temperature	Temperatur
τ	Time constant	Zeitkonstante
$\tan \delta$	Dissipation factor	Verlustfaktor
$\tan \delta_D$	Dielectric component of dissipation factor	Dielektrischer Anteil des Verlustfaktors
$\tan \delta_P$	Parallel component of dissipation factor	Parallelanteil des Verlustfaktors
$\tan \delta_S$	Series component of dissipation factor	Serienanteil des Verlustfaktors
T_A	Ambient temperature	Umgebungstemperatur
T_{max}	Upper category temperature	Obere Kategorietemperatur
T_{min}	Lower category temperature	Untere Kategorietemperatur
t_{OL}	Operating life at operating temperature and voltage	Betriebszeit bei Betriebstemperatur und -spannung
T_{op}	Operating temperature	Betriebstemperatur
T_R	Rated temperature	Nenntemperatur
T_{ref}	Reference temperature	Referenztemperatur
t_{SL}	Reference service life	Referenz-Lebensdauer
V_{AC}	AC voltage	Wechselspannung

Symbol	English	German
V_C	Category voltage	Kategorie spannung
$V_{C,RMS}$	Category AC voltage	(Sinusförmige) Kategorie-Wechsel spannung
V_{CD}	Corona-discharge onset voltage	Teilentlade-Einsatz spannung
V_{ch}	Charging voltage	Ladespannung
V_{DC}	DC voltage	Gleichspannung
V_{FB}	Fly-back capacitor voltage	Spannung (Flyback)
V_i	Input voltage	Eingangsspannung
V_o	Output voltage	Ausgangssspannung
V_{op}	Operating voltage	Betriebsspannung
V_p	Peak pulse voltage	Impuls-Spitzen spannung
V_{pp}	Peak-to-peak voltage Impedance	Spannungshub
V_R	Rated voltage	Nennspannung
\hat{V}_R	Amplitude of rated AC voltage	Amplitude der Nenn-Wechsel spannung
V_{RMS}	(Sinusoidal) alternating voltage, root-mean-square value	(Sinusförmige) Wechsel spannung
V_{SC}	S-correction voltage	Spannung bei Anwendung "S-correction"
V_{sn}	Snubber capacitor voltage	Spannung bei Anwendung "Beschaltung"
Z	Impedance	Scheinwiderstand
e	Lead spacing	Rastermaß

Important notes

The following applies to all products named in this publication:

1. Some parts of this publication contain **statements about the suitability of our products for certain areas of application**. These statements are based on our knowledge of typical requirements that are often placed on our products in the areas of application concerned. We nevertheless expressly point out **that such statements cannot be regarded as binding statements about the suitability of our products for a particular customer application**. As a rule we are either unfamiliar with individual customer applications or less familiar with them than the customers themselves. For these reasons, it is always ultimately incumbent on the customer to check and decide whether a product with the properties described in the product specification is suitable for use in a particular customer application.
2. We also point out that **in individual cases, a malfunction of electronic components or failure before the end of their usual service life cannot be completely ruled out in the current state of the art, even if they are operated as specified**. In customer applications requiring a very high level of operational safety and especially in customer applications in which the malfunction or failure of an electronic component could endanger human life or health (e.g. in accident prevention or life-saving systems), it must therefore be ensured by means of suitable design of the customer application or other action taken by the customer (e.g. installation of protective circuitry or redundancy) that no injury or damage is sustained by third parties in the event of malfunction or failure of an electronic component.
3. **The warnings, cautions and product-specific notes must be observed.**
4. In order to satisfy certain technical requirements, **some of the products described in this publication may contain substances subject to restrictions in certain jurisdictions (e.g. because they are classed as hazardous)**. Useful information on this will be found in our Material Data Sheets on the Internet (www.tdk-electronics.tdk.com/material). Should you have any more detailed questions, please contact our sales offices.
5. We constantly strive to improve our products. Consequently, **the products described in this publication may change from time to time**. The same is true of the corresponding product specifications. Please check therefore to what extent product descriptions and specifications contained in this publication are still applicable before or when you place an order.

We also **reserve the right to discontinue production and delivery of products**. Consequently, we cannot guarantee that all products named in this publication will always be available. The aforementioned does not apply in the case of individual agreements deviating from the foregoing for customer-specific products.
6. Unless otherwise agreed in individual contracts, **all orders are subject to our General Terms and Conditions of Supply**.
7. **Our manufacturing sites serving the automotive business apply the IATF 16949 standard**. The IATF certifications confirm our compliance with requirements regarding the quality management system in the automotive industry. Referring to customer requirements and customer specific requirements ("CSR") TDK always has and will continue to have the policy of respecting individual agreements. Even if IATF 16949 may appear to support the acceptance of unilateral requirements, we hereby like to emphasize that **only requirements mutually agreed upon can and will be implemented in our Quality Management System**. For clarification purposes we like to point out that obligations from IATF 16949 shall only become legally binding if individually agreed upon.
8. The trade names EPCOS, CeraCharge, CeraDiode, CeraLink, CeraPad, CeraPlas, CSMP, CTVS, DeltaCap, DigiSiMic, ExoCore, FilterCap, FormFit, LeaXield, MiniBlue, MiniCell, MKD, MKK, MotorCap, PCC, PhaseCap, PhaseCube, PhaseMod, PhiCap, PowerHap, PQSine, PQvar, SIFERRIT, SIFI, SIKOREL, SilverCap, SIMDAD, SiMic, SIMID, SineFormer, SIOV, ThermoFuse, WindCap are **trademarks registered or pending** in Europe and in other countries. Further information will be found on the Internet at www.tdk-electronics.tdk.com/trademarks.