

Metallized Polypropylene Capacitors (MKP/MFP)

Series/Type: B32692 ... B32694

The following products presented in this data sheet are being withdrawn.

Ordering Code	Substitute Product	Date of Withdrawal	Deadline Last Orders	Last Shipments
B32692A7682K289		2015-07-24	2016-01-31	2016-07-31
B32692A7682K189		2015-07-24	2016-01-31	2016-07-31
B32692A7682K020		2015-07-24	2016-01-31	2016-07-31



Ordering Code	Substitute Product	Date of Withdrawal	Deadline Last Orders	Last Shipments
B32692A7682K011		2015-07-24	2016-01-31	2016-07-31
B32692A7682K010		2015-07-24	2016-01-31	2016-07-31
B32692A7682K008		2015-07-24	2016-01-31	2016-07-31
B32692A7682J289		2015-07-24	2016-01-31	2016-07-31
B32692A7682J189		2015-07-24	2016-01-31	2016-07-31
B32692A7682J020		2015-07-24	2016-01-31	2016-07-31
B32692A7682J011		2015-07-24	2016-01-31	2016-07-31
B32692A7682J010		2015-07-24	2016-01-31	2016-07-31
B32692A7682J008		2015-07-24	2016-01-31	2016-07-31
B32692A7682A289		2015-07-24	2016-01-31	2016-07-31
B32692A7682A189		2015-07-24	2016-01-31	2016-07-31
B32692A7682A020		2015-07-24	2016-01-31	2016-07-31
B32692A7682A011		2015-07-24	2016-01-31	2016-07-31
B32692A7682A010		2015-07-24	2016-01-31	2016-07-31
B32692A7682A008		2015-07-24	2016-01-31	2016-07-31
B32692A7472K289		2015-07-24	2016-01-31	2016-07-31
B32692A7472K189		2015-07-24	2016-01-31	2016-07-31
B32692A7472K020		2015-07-24	2016-01-31	2016-07-31
B32692A7472K011		2015-07-24	2016-01-31	2016-07-31
B32692A7472K010		2015-07-24	2016-01-31	2016-07-31
B32692A7472K008		2015-07-24	2016-01-31	2016-07-31
B32692A7472J289		2015-07-24	2016-01-31	2016-07-31
B32692A7472J189		2015-07-24	2016-01-31	2016-07-31
B32692A7472J020		2015-07-24	2016-01-31	2016-07-31
B32692A7472J011		2015-07-24	2016-01-31	2016-07-31
B32692A7472J010		2015-07-24	2016-01-31	2016-07-31
B32692A7472J008		2015-07-24	2016-01-31	2016-07-31
B32692A7472A289		2015-07-24	2016-01-31	2016-07-31
B32692A7472A189		2015-07-24	2016-01-31	2016-07-31
B32692A7472A020		2015-07-24	2016-01-31	2016-07-31
B32692A7472A011		2015-07-24	2016-01-31	2016-07-31
B32692A7472A010		2015-07-24	2016-01-31	2016-07-31
B32692A7472A008		2015-07-24	2016-01-31	2016-07-31
B32692A7332K289		2015-07-24	2016-01-31	2016-07-31
B32692A7332K189		2015-07-24	2016-01-31	2016-07-31
B32692A7332K020		2015-07-24	2016-01-31	2016-07-31
B32692A7332K011		2015-07-24	2016-01-31	2016-07-31
B32692A7332K010		2015-07-24	2016-01-31	2016-07-31



Ordering Code	Substitute Product	Date of Withdrawal	Deadline Last Orders	Last Shipments
B32692A7332K008		2015-07-24	2016-01-31	2016-07-31
B32692A7332J289		2015-07-24	2016-01-31	2016-07-31
B32692A7332J189		2015-07-24	2016-01-31	2016-07-31
B32692A7332J020		2015-07-24	2016-01-31	2016-07-31
B32692A7332J011		2015-07-24	2016-01-31	2016-07-31
B32692A7332J010		2015-07-24	2016-01-31	2016-07-31
B32692A7332J008		2015-07-24	2016-01-31	2016-07-31
B32692A7332A289		2015-07-24	2016-01-31	2016-07-31
B32692A7332A189		2015-07-24	2016-01-31	2016-07-31
B32692A7332A020		2015-07-24	2016-01-31	2016-07-31
B32692A7332A011		2015-07-24	2016-01-31	2016-07-31
B32692A7332A010		2015-07-24	2016-01-31	2016-07-31
B32692A7332A008		2015-07-24	2016-01-31	2016-07-31
B32692A7222K289		2015-07-24	2016-01-31	2016-07-31
B32692A7222K189		2015-07-24	2016-01-31	2016-07-31
B32692A7222K020		2015-07-24	2016-01-31	2016-07-31
B32692A7222K011		2015-07-24	2016-01-31	2016-07-31
B32692A7222K010		2015-07-24	2016-01-31	2016-07-31
B32692A7222K008		2015-07-24	2016-01-31	2016-07-31
B32692A7222J289		2015-07-24	2016-01-31	2016-07-31
B32692A7222J189		2015-07-24	2016-01-31	2016-07-31
B32692A7222J020		2015-07-24	2016-01-31	2016-07-31
B32692A7222J011		2015-07-24	2016-01-31	2016-07-31
B32692A7222J010		2015-07-24	2016-01-31	2016-07-31
B32692A7222J008		2015-07-24	2016-01-31	2016-07-31
B32692A7222A289		2015-07-24	2016-01-31	2016-07-31
B32692A7222A189		2015-07-24	2016-01-31	2016-07-31
B32692A7222A020		2015-07-24	2016-01-31	2016-07-31
B32692A7222A011		2015-07-24	2016-01-31	2016-07-31
B32692A7222A010		2015-07-24	2016-01-31	2016-07-31
B32692A7222A008		2015-07-24	2016-01-31	2016-07-31
B32692A7153K289		2015-07-24	2016-01-31	2016-07-31
B32692A7153K189		2015-07-24	2016-01-31	2016-07-31
B32692A7153K020		2015-07-24	2016-01-31	2016-07-31
B32692A7153K011		2015-07-24	2016-01-31	2016-07-31
B32692A7153K010		2015-07-24	2016-01-31	2016-07-31
B32692A7153K008		2015-07-24	2016-01-31	2016-07-31
B32692A7153J289		2015-07-24	2016-01-31	2016-07-31



Ordering Code	Substitute Product	Date of Withdrawal	Deadline Last Orders	Last Shipments
B32692A7153J189		2015-07-24	2016-01-31	2016-07-31
B32692A7153J020		2015-07-24	2016-01-31	2016-07-31
B32692A7153J011		2015-07-24	2016-01-31	2016-07-31
B32692A7153J010		2015-07-24	2016-01-31	2016-07-31
B32692A7153J008		2015-07-24	2016-01-31	2016-07-31
B32692A7153A289		2015-07-24	2016-01-31	2016-07-31
B32692A7153A189		2015-07-24	2016-01-31	2016-07-31
B32692A7153A020		2015-07-24	2016-01-31	2016-07-31
B32692A7153A011		2015-07-24	2016-01-31	2016-07-31
B32692A7153A010		2015-07-24	2016-01-31	2016-07-31
B32692A7153A008		2015-07-24	2016-01-31	2016-07-31
B32692A7152K289		2015-07-24	2016-01-31	2016-07-31
B32692A7152K189		2015-07-24	2016-01-31	2016-07-31
B32692A7152K020		2015-07-24	2016-01-31	2016-07-31
B32692A7152K011		2015-07-24	2016-01-31	2016-07-31
B32692A7152K010		2015-07-24	2016-01-31	2016-07-31
B32692A7152K008		2015-07-24	2016-01-31	2016-07-31
B32692A7152J289		2015-07-24	2016-01-31	2016-07-31
B32692A7152J189		2015-07-24	2016-01-31	2016-07-31
B32692A7152J020		2015-07-24	2016-01-31	2016-07-31
B32692A7152J011		2015-07-24	2016-01-31	2016-07-31
B32692A7152J010		2015-07-24	2016-01-31	2016-07-31
B32692A7152J008		2015-07-24	2016-01-31	2016-07-31
B32692A7152A289		2015-07-24	2016-01-31	2016-07-31
B32692A7152A189		2015-07-24	2016-01-31	2016-07-31
B32692A7152A020		2015-07-24	2016-01-31	2016-07-31
B32692A7152A011		2015-07-24	2016-01-31	2016-07-31
B32692A7152A010		2015-07-24	2016-01-31	2016-07-31
B32692A7152A008		2015-07-24	2016-01-31	2016-07-31
B32692A7103K289		2015-07-24	2016-01-31	2016-07-31
B32692A7103K189		2015-07-24	2016-01-31	2016-07-31
B32692A7103K020		2015-07-24	2016-01-31	2016-07-31
B32692A7103K011		2015-07-24	2016-01-31	2016-07-31
B32692A7103K010		2015-07-24	2016-01-31	2016-07-31
B32692A7103K008		2015-07-24	2016-01-31	2016-07-31
B32692A7103J289		2015-07-24	2016-01-31	2016-07-31
B32692A7103J189		2015-07-24	2016-01-31	2016-07-31
B32692A7103J020		2015-07-24	2016-01-31	2016-07-31



Ordering Code	Substitute Product	Date of Withdrawal	Deadline Last Orders	Last Shipments
B32692A7103J011		2015-07-24	2016-01-31	2016-07-31
B32692A7103J010		2015-07-24	2016-01-31	2016-07-31
B32692A7103J008		2015-07-24	2016-01-31	2016-07-31
B32692A7103A289		2015-07-24	2016-01-31	2016-07-31
B32692A7103A189		2015-07-24	2016-01-31	2016-07-31
B32692A7103A020		2015-07-24	2016-01-31	2016-07-31
B32692A7103A011		2015-07-24	2016-01-31	2016-07-31
B32692A7103A010		2015-07-24	2016-01-31	2016-07-31
B32692A7103A008		2015-07-24	2016-01-31	2016-07-31
B32692A7102K289		2015-07-24	2016-01-31	2016-07-31
B32692A7102K189		2015-07-24	2016-01-31	2016-07-31
B32692A7102K020		2015-07-24	2016-01-31	2016-07-31
B32692A7102K011		2015-07-24	2016-01-31	2016-07-31
B32692A7102K010		2015-07-24	2016-01-31	2016-07-31
B32692A7102K008		2015-07-24	2016-01-31	2016-07-31
B32692A7102J289		2015-07-24	2016-01-31	2016-07-31
B32692A7102J189		2015-07-24	2016-01-31	2016-07-31
B32692A7102J020		2015-07-24	2016-01-31	2016-07-31
B32692A7102J011		2015-07-24	2016-01-31	2016-07-31
B32692A7102J010		2015-07-24	2016-01-31	2016-07-31
B32692A7102J008		2015-07-24	2016-01-31	2016-07-31
B32692A7102A289		2015-07-24	2016-01-31	2016-07-31
B32692A7102A189		2015-07-24	2016-01-31	2016-07-31
B32692A7102A020		2015-07-24	2016-01-31	2016-07-31
B32692A7102A011		2015-07-24	2016-01-31	2016-07-31
B32692A7102A010		2015-07-24	2016-01-31	2016-07-31
B32692A7102A008		2015-07-24	2016-01-31	2016-07-31
B32692A6682K289		2015-07-24	2016-01-31	2016-07-31
B32692A6682K189		2015-07-24	2016-01-31	2016-07-31
B32692A6682K020		2015-07-24	2016-01-31	2016-07-31
B32692A6682K011		2015-07-24	2016-01-31	2016-07-31
B32692A6682K010		2015-07-24	2016-01-31	2016-07-31
B32692A6682K008		2015-07-24	2016-01-31	2016-07-31
B32692A6682J289		2015-07-24	2016-01-31	2016-07-31
B32692A6682J189		2015-07-24	2016-01-31	2016-07-31
B32692A6682J020		2015-07-24	2016-01-31	2016-07-31
B32692A6682J011		2015-07-24	2016-01-31	2016-07-31
B32692A6682J010		2015-07-24	2016-01-31	2016-07-31



Ordering Code	Substitute Product	Date of Withdrawal	Deadline Last Orders	Last Shipments
B32692A6682J008		2015-07-24	2016-01-31	2016-07-31
B32692A6682A289		2015-07-24	2016-01-31	2016-07-31
B32692A6682A189		2015-07-24	2016-01-31	2016-07-31
B32692A6682A020		2015-07-24	2016-01-31	2016-07-31
B32692A6682A011		2015-07-24	2016-01-31	2016-07-31
B32692A6682A010		2015-07-24	2016-01-31	2016-07-31
B32692A6682A008		2015-07-24	2016-01-31	2016-07-31
B32692A6473K289		2015-07-24	2016-01-31	2016-07-31
B32692A6473K189		2015-07-24	2016-01-31	2016-07-31
B32692A6473K020		2015-07-24	2016-01-31	2016-07-31
B32692A6473K011		2015-07-24	2016-01-31	2016-07-31
B32692A6473K010		2015-07-24	2016-01-31	2016-07-31
B32692A6473K008		2015-07-24	2016-01-31	2016-07-31
B32692A6473J289		2015-07-24	2016-01-31	2016-07-31
B32692A6473J189		2015-07-24	2016-01-31	2016-07-31
B32692A6473J020		2015-07-24	2016-01-31	2016-07-31
B32692A6473J011		2015-07-24	2016-01-31	2016-07-31
B32692A6473J010		2015-07-24	2016-01-31	2016-07-31
B32692A6473J008		2015-07-24	2016-01-31	2016-07-31
B32692A6473A289		2015-07-24	2016-01-31	2016-07-31
B32692A6473A189		2015-07-24	2016-01-31	2016-07-31
B32692A6473A020		2015-07-24	2016-01-31	2016-07-31
B32692A6473A011		2015-07-24	2016-01-31	2016-07-31
B32692A6473A010		2015-07-24	2016-01-31	2016-07-31
B32692A6473A008		2015-07-24	2016-01-31	2016-07-31
B32692A6472K289		2015-07-24	2016-01-31	2016-07-31
B32692A6472K189		2015-07-24	2016-01-31	2016-07-31
B32692A6472K020		2015-07-24	2016-01-31	2016-07-31
B32692A6472K011		2015-07-24	2016-01-31	2016-07-31
B32692A6472K010		2015-07-24	2016-01-31	2016-07-31
B32692A6472K008		2015-07-24	2016-01-31	2016-07-31
B32692A6472J289		2015-07-24	2016-01-31	2016-07-31
B32692A6472J189		2015-07-24	2016-01-31	2016-07-31
B32692A6472J020		2015-07-24	2016-01-31	2016-07-31
B32692A6472J011		2015-07-24	2016-01-31	2016-07-31
B32692A6472J010		2015-07-24	2016-01-31	2016-07-31
B32692A6472J008		2015-07-24	2016-01-31	2016-07-31
B32692A6472A289		2015-07-24	2016-01-31	2016-07-31



Ordering Code	Substitute Product	Date of Withdrawal	Deadline Last Orders	Last Shipments
B32692A6472A189		2015-07-24	2016-01-31	2016-07-31
B32692A6472A020		2015-07-24	2016-01-31	2016-07-31
B32692A6472A011		2015-07-24	2016-01-31	2016-07-31
B32692A6472A010		2015-07-24	2016-01-31	2016-07-31
B32692A6472A008		2015-07-24	2016-01-31	2016-07-31
B32692A6333K289		2015-07-24	2016-01-31	2016-07-31
B32692A6333K189		2015-07-24	2016-01-31	2016-07-31
B32692A6333K020		2015-07-24	2016-01-31	2016-07-31
B32692A6333K011		2015-07-24	2016-01-31	2016-07-31
B32692A6333K010		2015-07-24	2016-01-31	2016-07-31
B32692A6333K008		2015-07-24	2016-01-31	2016-07-31
B32692A6333J289		2015-07-24	2016-01-31	2016-07-31
B32692A6333J189		2015-07-24	2016-01-31	2016-07-31
B32692A6333J020		2015-07-24	2016-01-31	2016-07-31
B32692A6333J011		2015-07-24	2016-01-31	2016-07-31
B32692A6333J010		2015-07-24	2016-01-31	2016-07-31
B32692A6333J008		2015-07-24	2016-01-31	2016-07-31
B32692A6333A289		2015-07-24	2016-01-31	2016-07-31
B32692A6333A189		2015-07-24	2016-01-31	2016-07-31
B32692A6333A020		2015-07-24	2016-01-31	2016-07-31
B32692A6333A011		2015-07-24	2016-01-31	2016-07-31
B32692A6333A010		2015-07-24	2016-01-31	2016-07-31
B32692A6333A008		2015-07-24	2016-01-31	2016-07-31
B32692A6332K289		2015-07-24	2016-01-31	2016-07-31
B32692A6332K189		2015-07-24	2016-01-31	2016-07-31
B32692A6332K020		2015-07-24	2016-01-31	2016-07-31
B32692A6332K011		2015-07-24	2016-01-31	2016-07-31
B32692A6332K010		2015-07-24	2016-01-31	2016-07-31
B32692A6332K008		2015-07-24	2016-01-31	2016-07-31
B32692A6332J289		2015-07-24	2016-01-31	2016-07-31
B32692A6332J189		2015-07-24	2016-01-31	2016-07-31
B32692A6332J020		2015-07-24	2016-01-31	2016-07-31
B32692A6332J011		2015-07-24	2016-01-31	2016-07-31
B32692A6332J010		2015-07-24	2016-01-31	2016-07-31
B32692A6332J008		2015-07-24	2016-01-31	2016-07-31
B32692A6332A289		2015-07-24	2016-01-31	2016-07-31
B32692A6332A189		2015-07-24	2016-01-31	2016-07-31
B32692A6332A020		2015-07-24	2016-01-31	2016-07-31



Ordering Code	Substitute Product	Date of Withdrawal	Deadline Last Orders	Last Shipments
B32692A6332A011		2015-07-24	2016-01-31	2016-07-31
B32692A6332A010		2015-07-24	2016-01-31	2016-07-31
B32692A6332A008		2015-07-24	2016-01-31	2016-07-31
B32692A6223K289		2015-07-24	2016-01-31	2016-07-31
B32692A6223K189		2015-07-24	2016-01-31	2016-07-31
B32692A6223K020		2015-07-24	2016-01-31	2016-07-31
B32692A6223K011		2015-07-24	2016-01-31	2016-07-31
B32692A6223K010		2015-07-24	2016-01-31	2016-07-31
B32692A6223K008		2015-07-24	2016-01-31	2016-07-31
B32692A6223J289		2015-07-24	2016-01-31	2016-07-31
B32692A6223J189		2015-07-24	2016-01-31	2016-07-31
B32692A6223J020		2015-07-24	2016-01-31	2016-07-31
B32692A6223J011		2015-07-24	2016-01-31	2016-07-31
B32692A6223J010		2015-07-24	2016-01-31	2016-07-31
B32692A6223J008		2015-07-24	2016-01-31	2016-07-31
B32692A6223A289		2015-07-24	2016-01-31	2016-07-31
B32692A6223A189		2015-07-24	2016-01-31	2016-07-31
B32692A6223A020		2015-07-24	2016-01-31	2016-07-31
B32692A6223A011		2015-07-24	2016-01-31	2016-07-31
B32692A6223A010		2015-07-24	2016-01-31	2016-07-31
B32692A6223A008		2015-07-24	2016-01-31	2016-07-31
B32692A6222K289		2015-07-24	2016-01-31	2016-07-31
B32692A6222K189		2015-07-24	2016-01-31	2016-07-31
B32692A6222K020		2015-07-24	2016-01-31	2016-07-31
B32692A6222K011		2015-07-24	2016-01-31	2016-07-31
B32692A6222K010		2015-07-24	2016-01-31	2016-07-31
B32692A6222K008		2015-07-24	2016-01-31	2016-07-31
B32692A6222J289		2015-07-24	2016-01-31	2016-07-31
B32692A6222J189		2015-07-24	2016-01-31	2016-07-31
B32692A6222J020		2015-07-24	2016-01-31	2016-07-31
B32692A6222J011		2015-07-24	2016-01-31	2016-07-31
B32692A6222J010		2015-07-24	2016-01-31	2016-07-31
B32692A6222J008		2015-07-24	2016-01-31	2016-07-31
B32692A6222A289		2015-07-24	2016-01-31	2016-07-31
B32692A6222A189		2015-07-24	2016-01-31	2016-07-31
B32692A6222A020		2015-07-24	2016-01-31	2016-07-31
B32692A6222A011		2015-07-24	2016-01-31	2016-07-31
B32692A6222A010		2015-07-24	2016-01-31	2016-07-31



Ordering Code	Substitute Product	Date of Withdrawal	Deadline Last Orders	Last Shipments
B32692A6222A008		2015-07-24	2016-01-31	2016-07-31
B32692A6153K289		2015-07-24	2016-01-31	2016-07-31
B32692A6153K189		2015-07-24	2016-01-31	2016-07-31
B32692A6153K020		2015-07-24	2016-01-31	2016-07-31
B32692A6153K011		2015-07-24	2016-01-31	2016-07-31
B32692A6153K010		2015-07-24	2016-01-31	2016-07-31
B32692A6153K008		2015-07-24	2016-01-31	2016-07-31
B32692A6153J289		2015-07-24	2016-01-31	2016-07-31
B32692A6153J189		2015-07-24	2016-01-31	2016-07-31
B32692A6153J020		2015-07-24	2016-01-31	2016-07-31
B32692A6153J011		2015-07-24	2016-01-31	2016-07-31
B32692A6153J010		2015-07-24	2016-01-31	2016-07-31
B32692A6153J008		2015-07-24	2016-01-31	2016-07-31
B32692A6153A289		2015-07-24	2016-01-31	2016-07-31
B32692A6153A189		2015-07-24	2016-01-31	2016-07-31
B32692A6153A020		2015-07-24	2016-01-31	2016-07-31
B32692A6153A011		2015-07-24	2016-01-31	2016-07-31
B32692A6153A010		2015-07-24	2016-01-31	2016-07-31
B32692A6153A008		2015-07-24	2016-01-31	2016-07-31
B32692A6103K289		2015-07-24	2016-01-31	2016-07-31
B32692A6103K189		2015-07-24	2016-01-31	2016-07-31
B32692A6103K020		2015-07-24	2016-01-31	2016-07-31
B32692A6103K011		2015-07-24	2016-01-31	2016-07-31
B32692A6103K010		2015-07-24	2016-01-31	2016-07-31
B32692A6103K008		2015-07-24	2016-01-31	2016-07-31
B32692A6103J289		2015-07-24	2016-01-31	2016-07-31
B32692A6103J189		2015-07-24	2016-01-31	2016-07-31
B32692A6103J020		2015-07-24	2016-01-31	2016-07-31
B32692A6103J011		2015-07-24	2016-01-31	2016-07-31
B32692A6103J010		2015-07-24	2016-01-31	2016-07-31
B32692A6103J008		2015-07-24	2016-01-31	2016-07-31
B32692A6103A289		2015-07-24	2016-01-31	2016-07-31
B32692A6103A189		2015-07-24	2016-01-31	2016-07-31
B32692A6103A020		2015-07-24	2016-01-31	2016-07-31
B32692A6103A011		2015-07-24	2016-01-31	2016-07-31
B32692A6103A010		2015-07-24	2016-01-31	2016-07-31
B32692A6103A008		2015-07-24	2016-01-31	2016-07-31
B32692A2682K289		2015-07-24	2016-01-31	2016-07-31



Ordering Code	Substitute Product	Date of Withdrawal	Deadline Last Orders	Last Shipments
B32692A2682K189		2015-07-24	2016-01-31	2016-07-31
B32692A2682K020		2015-07-24	2016-01-31	2016-07-31
B32692A2682K011		2015-07-24	2016-01-31	2016-07-31
B32692A2682K010		2015-07-24	2016-01-31	2016-07-31
B32692A2682K008		2015-07-24	2016-01-31	2016-07-31
B32692A2682J289		2015-07-24	2016-01-31	2016-07-31
B32692A2682J189		2015-07-24	2016-01-31	2016-07-31
B32692A2682J020		2015-07-24	2016-01-31	2016-07-31
B32692A2682J011		2015-07-24	2016-01-31	2016-07-31
B32692A2682J010		2015-07-24	2016-01-31	2016-07-31
B32692A2682J008		2015-07-24	2016-01-31	2016-07-31
B32692A2682A289		2015-07-24	2016-01-31	2016-07-31
B32692A2682A189		2015-07-24	2016-01-31	2016-07-31
B32692A2682A020		2015-07-24	2016-01-31	2016-07-31
B32692A2682A011		2015-07-24	2016-01-31	2016-07-31
B32692A2682A010		2015-07-24	2016-01-31	2016-07-31
B32692A2682A008		2015-07-24	2016-01-31	2016-07-31
B32692A2681M289		2015-07-24	2016-01-31	2016-07-31
B32692A2681M189		2015-07-24	2016-01-31	2016-07-31
B32692A2681M020		2015-07-24	2016-01-31	2016-07-31
B32692A2681M011		2015-07-24	2016-01-31	2016-07-31
B32692A2681M010		2015-07-24	2016-01-31	2016-07-31
B32692A2681M008		2015-07-24	2016-01-31	2016-07-31
B32692A2681K289		2015-07-24	2016-01-31	2016-07-31
B32692A2681K189		2015-07-24	2016-01-31	2016-07-31
B32692A2681K020		2015-07-24	2016-01-31	2016-07-31
B32692A2681K011		2015-07-24	2016-01-31	2016-07-31
B32692A2681K010		2015-07-24	2016-01-31	2016-07-31
B32692A2681K008		2015-07-24	2016-01-31	2016-07-31
B32692A2472K289		2015-07-24	2016-01-31	2016-07-31
B32692A2472K189		2015-07-24	2016-01-31	2016-07-31
B32692A2472K020		2015-07-24	2016-01-31	2016-07-31
B32692A2472K011		2015-07-24	2016-01-31	2016-07-31
B32692A2472K010		2015-07-24	2016-01-31	2016-07-31
B32692A2472K008		2015-07-24	2016-01-31	2016-07-31
B32692A2472J289		2015-07-24	2016-01-31	2016-07-31
B32692A2472J189		2015-07-24	2016-01-31	2016-07-31
B32692A2472J020		2015-07-24	2016-01-31	2016-07-31



Ordering Code	Substitute Product	Date of Withdrawal	Deadline Last Orders	Last Shipments
B32692A2472J011		2015-07-24	2016-01-31	2016-07-31
B32692A2472J010		2015-07-24	2016-01-31	2016-07-31
B32692A2472J008		2015-07-24	2016-01-31	2016-07-31
B32692A2472A289		2015-07-24	2016-01-31	2016-07-31
B32692A2472A189		2015-07-24	2016-01-31	2016-07-31
B32692A2472A020		2015-07-24	2016-01-31	2016-07-31
B32692A2472A011		2015-07-24	2016-01-31	2016-07-31
B32692A2472A010		2015-07-24	2016-01-31	2016-07-31
B32692A2472A008		2015-07-24	2016-01-31	2016-07-31
B32692A2471M289		2015-07-24	2016-01-31	2016-07-31
B32692A2471M189		2015-07-24	2016-01-31	2016-07-31
B32692A2471M020		2015-07-24	2016-01-31	2016-07-31
B32692A2471M011		2015-07-24	2016-01-31	2016-07-31
B32692A2471M010		2015-07-24	2016-01-31	2016-07-31
B32692A2471M008		2015-07-24	2016-01-31	2016-07-31
B32692A2471K289		2015-07-24	2016-01-31	2016-07-31
B32692A2471K189		2015-07-24	2016-01-31	2016-07-31
B32692A2471K020		2015-07-24	2016-01-31	2016-07-31
B32692A2471K011		2015-07-24	2016-01-31	2016-07-31
B32692A2471K010		2015-07-24	2016-01-31	2016-07-31
B32692A2471K008		2015-07-24	2016-01-31	2016-07-31
B32692A2332K289		2015-07-24	2016-01-31	2016-07-31
B32692A2332K189		2015-07-24	2016-01-31	2016-07-31
B32692A2332K020		2015-07-24	2016-01-31	2016-07-31
B32692A2332K011		2015-07-24	2016-01-31	2016-07-31
B32692A2332K010		2015-07-24	2016-01-31	2016-07-31
B32692A2332K008		2015-07-24	2016-01-31	2016-07-31
B32692A2332J289		2015-07-24	2016-01-31	2016-07-31
B32692A2332J189		2015-07-24	2016-01-31	2016-07-31
B32692A2332J020		2015-07-24	2016-01-31	2016-07-31
B32692A2332J011		2015-07-24	2016-01-31	2016-07-31
B32692A2332J010		2015-07-24	2016-01-31	2016-07-31
B32692A2332J008		2015-07-24	2016-01-31	2016-07-31
B32692A2332A289		2015-07-24	2016-01-31	2016-07-31
B32692A2332A189		2015-07-24	2016-01-31	2016-07-31
B32692A2332A020		2015-07-24	2016-01-31	2016-07-31
B32692A2332A011		2015-07-24	2016-01-31	2016-07-31
B32692A2332A010		2015-07-24	2016-01-31	2016-07-31



Ordering Code	Substitute Product	Date of Withdrawal	Deadline Last Orders	Last Shipments
B32692A2332A008		2015-07-24	2016-01-31	2016-07-31
B32692A2222K289		2015-07-24	2016-01-31	2016-07-31
B32692A2222K189		2015-07-24	2016-01-31	2016-07-31
B32692A2222K020		2015-07-24	2016-01-31	2016-07-31
B32692A2222K011		2015-07-24	2016-01-31	2016-07-31
B32692A2222K010		2015-07-24	2016-01-31	2016-07-31
B32692A2222K008		2015-07-24	2016-01-31	2016-07-31
B32692A2222J289		2015-07-24	2016-01-31	2016-07-31
B32692A2222J189		2015-07-24	2016-01-31	2016-07-31
B32692A2222J020		2015-07-24	2016-01-31	2016-07-31
B32692A2222J011		2015-07-24	2016-01-31	2016-07-31
B32692A2222J010		2015-07-24	2016-01-31	2016-07-31
B32692A2222J008		2015-07-24	2016-01-31	2016-07-31
B32692A2222A289		2015-07-24	2016-01-31	2016-07-31
B32692A2222A189		2015-07-24	2016-01-31	2016-07-31
B32692A2222A020		2015-07-24	2016-01-31	2016-07-31
B32692A2222A011		2015-07-24	2016-01-31	2016-07-31
B32692A2222A010		2015-07-24	2016-01-31	2016-07-31
B32692A2222A008		2015-07-24	2016-01-31	2016-07-31
B32692A2152K289		2015-07-24	2016-01-31	2016-07-31
B32692A2152K189		2015-07-24	2016-01-31	2016-07-31
B32692A2152K020		2015-07-24	2016-01-31	2016-07-31
B32692A2152K011		2015-07-24	2016-01-31	2016-07-31
B32692A2152K010		2015-07-24	2016-01-31	2016-07-31
B32692A2152K008		2015-07-24	2016-01-31	2016-07-31
B32692A2152J289		2015-07-24	2016-01-31	2016-07-31
B32692A2152J189		2015-07-24	2016-01-31	2016-07-31
B32692A2152J020		2015-07-24	2016-01-31	2016-07-31
B32692A2152J011		2015-07-24	2016-01-31	2016-07-31
B32692A2152J010		2015-07-24	2016-01-31	2016-07-31
B32692A2152J008		2015-07-24	2016-01-31	2016-07-31
B32692A2152A289		2015-07-24	2016-01-31	2016-07-31
B32692A2152A189		2015-07-24	2016-01-31	2016-07-31
B32692A2152A020		2015-07-24	2016-01-31	2016-07-31
B32692A2152A011		2015-07-24	2016-01-31	2016-07-31
B32692A2152A010		2015-07-24	2016-01-31	2016-07-31
B32692A2152A008		2015-07-24	2016-01-31	2016-07-31
B32692A2102K289		2015-07-24	2016-01-31	2016-07-31



Ordering Code	Substitute Product	Date of Withdrawal	Deadline Last Orders	Last Shipments
B32692A2102K189		2015-07-24	2016-01-31	2016-07-31
B32692A2102K020		2015-07-24	2016-01-31	2016-07-31
B32692A2102K011		2015-07-24	2016-01-31	2016-07-31
B32692A2102K010		2015-07-24	2016-01-31	2016-07-31
B32692A2102K008		2015-07-24	2016-01-31	2016-07-31
B32692A2102J289		2015-07-24	2016-01-31	2016-07-31
B32692A2102J189		2015-07-24	2016-01-31	2016-07-31
B32692A2102J020		2015-07-24	2016-01-31	2016-07-31
B32692A2102J011		2015-07-24	2016-01-31	2016-07-31
B32692A2102J010		2015-07-24	2016-01-31	2016-07-31
B32692A2102J008		2015-07-24	2016-01-31	2016-07-31
B32692A2102A289		2015-07-24	2016-01-31	2016-07-31
B32692A2102A189		2015-07-24	2016-01-31	2016-07-31
B32692A2102A020		2015-07-24	2016-01-31	2016-07-31
B32692A2102A011		2015-07-24	2016-01-31	2016-07-31
B32692A2102A010		2015-07-24	2016-01-31	2016-07-31
B32692A2102A008		2015-07-24	2016-01-31	2016-07-31
B32692A1682K289		2015-07-24	2016-01-31	2016-07-31
B32692A1682K189		2015-07-24	2016-01-31	2016-07-31
B32692A1682K020		2015-07-24	2016-01-31	2016-07-31
B32692A1682K011		2015-07-24	2016-01-31	2016-07-31
B32692A1682K010		2015-07-24	2016-01-31	2016-07-31
B32692A1682K008		2015-07-24	2016-01-31	2016-07-31
B32692A1682J289		2015-07-24	2016-01-31	2016-07-31
B32692A1682J189		2015-07-24	2016-01-31	2016-07-31
B32692A1682J020		2015-07-24	2016-01-31	2016-07-31
B32692A1682J011		2015-07-24	2016-01-31	2016-07-31
B32692A1682J010		2015-07-24	2016-01-31	2016-07-31
B32692A1682J008		2015-07-24	2016-01-31	2016-07-31
B32692A1682A289		2015-07-24	2016-01-31	2016-07-31
B32692A1682A189		2015-07-24	2016-01-31	2016-07-31
B32692A1682A020		2015-07-24	2016-01-31	2016-07-31
B32692A1682A011		2015-07-24	2016-01-31	2016-07-31
B32692A1682A010		2015-07-24	2016-01-31	2016-07-31
B32692A1682A008		2015-07-24	2016-01-31	2016-07-31
B32692A1472K289		2015-07-24	2016-01-31	2016-07-31
B32692A1472K189		2015-07-24	2016-01-31	2016-07-31
B32692A1472K020		2015-07-24	2016-01-31	2016-07-31



Ordering Code	Substitute Product	Date of Withdrawal	Deadline Last Orders	Last Shipments
B32692A1472K011		2015-07-24	2016-01-31	2016-07-31
B32692A1472K010		2015-07-24	2016-01-31	2016-07-31
B32692A1472K008		2015-07-24	2016-01-31	2016-07-31
B32692A1472J289		2015-07-24	2016-01-31	2016-07-31
B32692A1472J189		2015-07-24	2016-01-31	2016-07-31
B32692A1472J020		2015-07-24	2016-01-31	2016-07-31
B32692A1472J011		2015-07-24	2016-01-31	2016-07-31
B32692A1472J010		2015-07-24	2016-01-31	2016-07-31
B32692A1472J008		2015-07-24	2016-01-31	2016-07-31
B32692A1472A289		2015-07-24	2016-01-31	2016-07-31
B32692A1472A189		2015-07-24	2016-01-31	2016-07-31
B32692A1472A020		2015-07-24	2016-01-31	2016-07-31
B32692A1472A011		2015-07-24	2016-01-31	2016-07-31
B32692A1472A010		2015-07-24	2016-01-31	2016-07-31
B32692A1472A008		2015-07-24	2016-01-31	2016-07-31
B32692A1332K289		2015-07-24	2016-01-31	2016-07-31
B32692A1332K189		2015-07-24	2016-01-31	2016-07-31
B32692A1332K020		2015-07-24	2016-01-31	2016-07-31
B32692A1332K011		2015-07-24	2016-01-31	2016-07-31
B32692A1332K010		2015-07-24	2016-01-31	2016-07-31
B32692A1332K008		2015-07-24	2016-01-31	2016-07-31
B32692A1332J289		2015-07-24	2016-01-31	2016-07-31
B32692A1332J189		2015-07-24	2016-01-31	2016-07-31
B32692A1332J020		2015-07-24	2016-01-31	2016-07-31
B32692A1332J011		2015-07-24	2016-01-31	2016-07-31
B32692A1332J010		2015-07-24	2016-01-31	2016-07-31
B32692A1332J008		2015-07-24	2016-01-31	2016-07-31
B32692A1332A289		2015-07-24	2016-01-31	2016-07-31
B32692A1332A189		2015-07-24	2016-01-31	2016-07-31
B32692A1332A020		2015-07-24	2016-01-31	2016-07-31
B32692A1332A011		2015-07-24	2016-01-31	2016-07-31
B32692A1332A010		2015-07-24	2016-01-31	2016-07-31
B32692A1332A008		2015-07-24	2016-01-31	2016-07-31
B32692A1222K289		2015-07-24	2016-01-31	2016-07-31
B32692A1222K189		2015-07-24	2016-01-31	2016-07-31
B32692A1222K020		2015-07-24	2016-01-31	2016-07-31
B32692A1222K011		2015-07-24	2016-01-31	2016-07-31
B32692A1222K010		2015-07-24	2016-01-31	2016-07-31



Ordering Code	Substitute Product	Date of Withdrawal	Deadline Last Orders	Last Shipments
B32692A1222K008		2015-07-24	2016-01-31	2016-07-31
B32692A1222J289		2015-07-24	2016-01-31	2016-07-31
B32692A1222J189		2015-07-24	2016-01-31	2016-07-31
B32692A1222J020		2015-07-24	2016-01-31	2016-07-31
B32692A1222J011		2015-07-24	2016-01-31	2016-07-31
B32692A1222J010		2015-07-24	2016-01-31	2016-07-31
B32692A1222J008		2015-07-24	2016-01-31	2016-07-31
B32692A1222A289		2015-07-24	2016-01-31	2016-07-31
B32692A1222A189		2015-07-24	2016-01-31	2016-07-31
B32692A1222A020		2015-07-24	2016-01-31	2016-07-31
B32692A1222A011		2015-07-24	2016-01-31	2016-07-31
B32692A1222A010		2015-07-24	2016-01-31	2016-07-31
B32692A1222A008		2015-07-24	2016-01-31	2016-07-31
B32692A1152K289		2015-07-24	2016-01-31	2016-07-31
B32692A1152K189		2015-07-24	2016-01-31	2016-07-31
B32692A1152K020		2015-07-24	2016-01-31	2016-07-31
B32692A1152K011		2015-07-24	2016-01-31	2016-07-31
B32692A1152K010		2015-07-24	2016-01-31	2016-07-31
B32692A1152K008		2015-07-24	2016-01-31	2016-07-31
B32692A1152J289		2015-07-24	2016-01-31	2016-07-31
B32692A1152J189		2015-07-24	2016-01-31	2016-07-31
B32692A1152J020		2015-07-24	2016-01-31	2016-07-31
B32692A1152J011		2015-07-24	2016-01-31	2016-07-31
B32692A1152J010		2015-07-24	2016-01-31	2016-07-31
B32692A1152J008		2015-07-24	2016-01-31	2016-07-31
B32692A1152A289		2015-07-24	2016-01-31	2016-07-31
B32692A1152A189		2015-07-24	2016-01-31	2016-07-31
B32692A1152A020		2015-07-24	2016-01-31	2016-07-31
B32692A1152A011		2015-07-24	2016-01-31	2016-07-31
B32692A1152A010		2015-07-24	2016-01-31	2016-07-31
B32692A1152A008		2015-07-24	2016-01-31	2016-07-31
B32692A1103K289		2015-07-24	2016-01-31	2016-07-31
B32692A1103K189		2015-07-24	2016-01-31	2016-07-31
B32692A1103K020		2015-07-24	2016-01-31	2016-07-31
B32692A1103K011		2015-07-24	2016-01-31	2016-07-31
B32692A1103K010		2015-07-24	2016-01-31	2016-07-31
B32692A1103K008		2015-07-24	2016-01-31	2016-07-31
B32692A1103J289		2015-07-24	2016-01-31	2016-07-31



Ordering Code	Substitute Product	Date of Withdrawal	Deadline Last Orders	Last Shipments
B32692A1103J189		2015-07-24	2016-01-31	2016-07-31
B32692A1103J020		2015-07-24	2016-01-31	2016-07-31
B32692A1103J011		2015-07-24	2016-01-31	2016-07-31
B32692A1103J010		2015-07-24	2016-01-31	2016-07-31
B32692A1103J008		2015-07-24	2016-01-31	2016-07-31
B32692A1103A289		2015-07-24	2016-01-31	2016-07-31
B32692A1103A189		2015-07-24	2016-01-31	2016-07-31
B32692A1103A020		2015-07-24	2016-01-31	2016-07-31
B32692A1103A011		2015-07-24	2016-01-31	2016-07-31
B32692A1103A010		2015-07-24	2016-01-31	2016-07-31
B32692A1103A008		2015-07-24	2016-01-31	2016-07-31
B32692A1102K289		2015-07-24	2016-01-31	2016-07-31
B32692A1102K189		2015-07-24	2016-01-31	2016-07-31
B32692A1102K020		2015-07-24	2016-01-31	2016-07-31
B32692A1102K011		2015-07-24	2016-01-31	2016-07-31
B32692A1102K010		2015-07-24	2016-01-31	2016-07-31
B32692A1102K008		2015-07-24	2016-01-31	2016-07-31
B32692A1102J289		2015-07-24	2016-01-31	2016-07-31
B32692A1102J189		2015-07-24	2016-01-31	2016-07-31
B32692A1102J020		2015-07-24	2016-01-31	2016-07-31
B32692A1102J011		2015-07-24	2016-01-31	2016-07-31
B32692A1102J010		2015-07-24	2016-01-31	2016-07-31
B32692A1102J008		2015-07-24	2016-01-31	2016-07-31
B32692A1102A289		2015-07-24	2016-01-31	2016-07-31
B32692A1102A189		2015-07-24	2016-01-31	2016-07-31
B32692A1102A020		2015-07-24	2016-01-31	2016-07-31
B32692A1102A011		2015-07-24	2016-01-31	2016-07-31
B32692A1102A010		2015-07-24	2016-01-31	2016-07-31
B32692A1102A008		2015-07-24	2016-01-31	2016-07-31
B32692A0682K289		2015-07-24	2016-01-31	2016-07-31
B32692A0682K189		2015-07-24	2016-01-31	2016-07-31
B32692A0682K020		2015-07-24	2016-01-31	2016-07-31
B32692A0682K011		2015-07-24	2016-01-31	2016-07-31
B32692A0682K010		2015-07-24	2016-01-31	2016-07-31
B32692A0682K008		2015-07-24	2016-01-31	2016-07-31
B32692A0682J289		2015-07-24	2016-01-31	2016-07-31
B32692A0682J189		2015-07-24	2016-01-31	2016-07-31
B32692A0682J020		2015-07-24	2016-01-31	2016-07-31



Ordering Code	Substitute Product	Date of Withdrawal	Deadline Last Orders	Last Shipments
B32692A0682J011		2015-07-24	2016-01-31	2016-07-31
B32692A0682J010		2015-07-24	2016-01-31	2016-07-31
B32692A0682J008		2015-07-24	2016-01-31	2016-07-31
B32692A0682A289		2015-07-24	2016-01-31	2016-07-31
B32692A0682A189		2015-07-24	2016-01-31	2016-07-31
B32692A0682A020		2015-07-24	2016-01-31	2016-07-31
B32692A0682A011		2015-07-24	2016-01-31	2016-07-31
B32692A0682A010		2015-07-24	2016-01-31	2016-07-31
B32692A0682A008		2015-07-24	2016-01-31	2016-07-31
B32692A0472K289		2015-07-24	2016-01-31	2016-07-31
B32692A0472K189		2015-07-24	2016-01-31	2016-07-31
B32692A0472K020		2015-07-24	2016-01-31	2016-07-31
B32692A0472K011		2015-07-24	2016-01-31	2016-07-31
B32692A0472K010		2015-07-24	2016-01-31	2016-07-31
B32692A0472K008		2015-07-24	2016-01-31	2016-07-31
B32692A0472J289		2015-07-24	2016-01-31	2016-07-31
B32692A0472J189		2015-07-24	2016-01-31	2016-07-31
B32692A0472J020		2015-07-24	2016-01-31	2016-07-31
B32692A0472J011		2015-07-24	2016-01-31	2016-07-31
B32692A0472J010		2015-07-24	2016-01-31	2016-07-31
B32692A0472J008		2015-07-24	2016-01-31	2016-07-31
B32692A0472A289		2015-07-24	2016-01-31	2016-07-31
B32692A0472A189		2015-07-24	2016-01-31	2016-07-31
B32692A0472A020		2015-07-24	2016-01-31	2016-07-31
B32692A0472A011		2015-07-24	2016-01-31	2016-07-31
B32692A0472A010		2015-07-24	2016-01-31	2016-07-31
B32692A0472A008		2015-07-24	2016-01-31	2016-07-31
B32692A0332K289		2015-07-24	2016-01-31	2016-07-31
B32692A0332K189		2015-07-24	2016-01-31	2016-07-31
B32692A0332K020		2015-07-24	2016-01-31	2016-07-31
B32692A0332K011		2015-07-24	2016-01-31	2016-07-31
B32692A0332K010		2015-07-24	2016-01-31	2016-07-31
B32692A0332K008		2015-07-24	2016-01-31	2016-07-31
B32692A0332J289		2015-07-24	2016-01-31	2016-07-31
B32692A0332J189		2015-07-24	2016-01-31	2016-07-31
B32692A0332J020		2015-07-24	2016-01-31	2016-07-31
B32692A0332J011		2015-07-24	2016-01-31	2016-07-31
B32692A0332J010		2015-07-24	2016-01-31	2016-07-31



Ordering Code	Substitute Product	Date of Withdrawal	Deadline Last Orders	Last Shipments
B32692A0332J008		2015-07-24	2016-01-31	2016-07-31
B32692A0332A289		2015-07-24	2016-01-31	2016-07-31
B32692A0332A189		2015-07-24	2016-01-31	2016-07-31
B32692A0332A020		2015-07-24	2016-01-31	2016-07-31
B32692A0332A011		2015-07-24	2016-01-31	2016-07-31
B32692A0332A010		2015-07-24	2016-01-31	2016-07-31
B32692A0332A008		2015-07-24	2016-01-31	2016-07-31
B32692A0222K289		2015-07-24	2016-01-31	2016-07-31
B32692A0222K189		2015-07-24	2016-01-31	2016-07-31
B32692A0222K020		2015-07-24	2016-01-31	2016-07-31
B32692A0222K011		2015-07-24	2016-01-31	2016-07-31
B32692A0222K010		2015-07-24	2016-01-31	2016-07-31
B32692A0222K008		2015-07-24	2016-01-31	2016-07-31
B32692A0222J289		2015-07-24	2016-01-31	2016-07-31
B32692A0222J189		2015-07-24	2016-01-31	2016-07-31
B32692A0222J020		2015-07-24	2016-01-31	2016-07-31
B32692A0222J011		2015-07-24	2016-01-31	2016-07-31
B32692A0222J010		2015-07-24	2016-01-31	2016-07-31
B32692A0222J008		2015-07-24	2016-01-31	2016-07-31
B32692A0222A289		2015-07-24	2016-01-31	2016-07-31
B32692A0222A189		2015-07-24	2016-01-31	2016-07-31
B32692A0222A020		2015-07-24	2016-01-31	2016-07-31
B32692A0222A011		2015-07-24	2016-01-31	2016-07-31
B32692A0222A010		2015-07-24	2016-01-31	2016-07-31
B32692A0222A008		2015-07-24	2016-01-31	2016-07-31
B32692A0153K289		2015-07-24	2016-01-31	2016-07-31
B32692A0153K189		2015-07-24	2016-01-31	2016-07-31
B32692A0153K020		2015-07-24	2016-01-31	2016-07-31
B32692A0153K011		2015-07-24	2016-01-31	2016-07-31
B32692A0153K010		2015-07-24	2016-01-31	2016-07-31
B32692A0153K008		2015-07-24	2016-01-31	2016-07-31
B32692A0153J289		2015-07-24	2016-01-31	2016-07-31
B32692A0153J189		2015-07-24	2016-01-31	2016-07-31
B32692A0153J020		2015-07-24	2016-01-31	2016-07-31
B32692A0153J011		2015-07-24	2016-01-31	2016-07-31
B32692A0153J010		2015-07-24	2016-01-31	2016-07-31
B32692A0153J008		2015-07-24	2016-01-31	2016-07-31
B32692A0153A289		2015-07-24	2016-01-31	2016-07-31



Ordering Code	Substitute Product	Date of Withdrawal	Deadline Last Orders	Last Shipments
B32692A0153A189		2015-07-24	2016-01-31	2016-07-31
B32692A0153A020		2015-07-24	2016-01-31	2016-07-31
B32692A0153A011		2015-07-24	2016-01-31	2016-07-31
B32692A0153A010		2015-07-24	2016-01-31	2016-07-31
B32692A0153A008		2015-07-24	2016-01-31	2016-07-31
B32692A0103K289		2015-07-24	2016-01-31	2016-07-31
B32692A0103K189		2015-07-24	2016-01-31	2016-07-31
B32692A0103K020		2015-07-24	2016-01-31	2016-07-31
B32692A0103K011		2015-07-24	2016-01-31	2016-07-31
B32692A0103K010		2015-07-24	2016-01-31	2016-07-31
B32692A0103K008		2015-07-24	2016-01-31	2016-07-31
B32692A0103J289		2015-07-24	2016-01-31	2016-07-31
B32692A0103J189		2015-07-24	2016-01-31	2016-07-31
B32692A0103J020		2015-07-24	2016-01-31	2016-07-31
B32692A0103J011		2015-07-24	2016-01-31	2016-07-31
B32692A0103J010		2015-07-24	2016-01-31	2016-07-31
B32692A0103J008		2015-07-24	2016-01-31	2016-07-31
B32692A0103A289		2015-07-24	2016-01-31	2016-07-31
B32692A0103A189		2015-07-24	2016-01-31	2016-07-31
B32692A0103A020		2015-07-24	2016-01-31	2016-07-31
B32692A0103A011		2015-07-24	2016-01-31	2016-07-31
B32692A0103A010		2015-07-24	2016-01-31	2016-07-31
B32692A0103A008		2015-07-24	2016-01-31	2016-07-31

For further information please contact your nearest EPCOS sales office, which will also support you in selecting a suitable substitute. The addresses of our worldwide sales network are presented at www.epcos.com/sales.

High pulse (wound)**Typical applications**

- High-frequency sinusoidal AC loads
- Electronic ballasts
- Ignition devices

Climatic

- Max. operating temperature: 110 °C
- Climatic category (IEC 60068-1): 55/100/56

Construction

- Dielectric: polypropylene (PP)
- Film metallized on one side and metal foils internally connected in series
- Direct welding
- Wound capacitor technology
- Epoxy resin coating (UL 94 V-0)

Features

- Very high pulse strength
- Self-healing properties
- RoHS-compatible

Terminals

- Crimped wire leads, lead-free tinned, lead length (6 – 1) mm or min. 20 mm
- Double crimped wire leads, lead-free tinned
- Straight wire leads, lead-free tinned, lead length (17 ±3) mm
- Different lead spacings (reduced and enlarged) available, lead length (6 – 1) mm

Marking

Manufacturer's logo, style and type (P6xx),
rated capacitance (coded),
capacitance tolerance (code letter),
rated DC voltage, date of manufacture (coded)

Delivery mode

Bulk (untaped)

Taped (Ammo pack or reel)

For notes on taping, refer to chapter "Taping and packing".

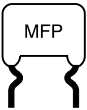

Dimensional drawings

Crimped leads

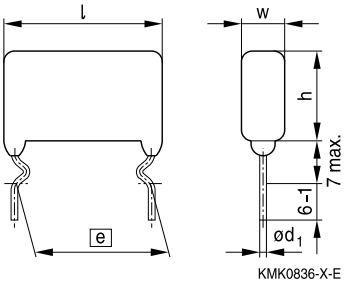

Double crimped leads

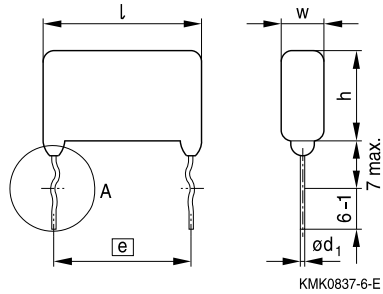

Straight leads

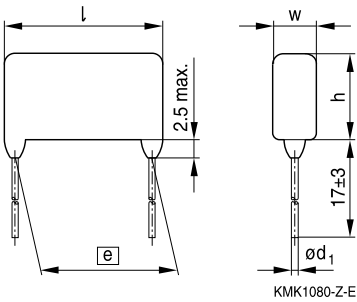

Detail of double crimped version

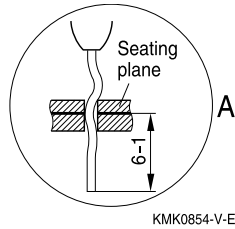

Lead spacing	Lead diameter	Type
$e \pm 0.8$	d_1	
15.0	0.8	B32692
22.5	0.8	B32693
27.5	0.8	B32694



B32692 ... B32694

High pulse (wound)

Overview of available types

Lead spacing	15.0 mm					22.5 mm					27.5 mm			
Type	B32692					B32693					B32694			
Page	5					7					9			
V_R (V DC)	630	1000	1250	1600	2000	630	1250	1600	2000	2500	630	1250	1600	2000
V_{RMS} (V AC)	300	400	450	450	500	300	450	450	500	750	300	450	450	500
C_R (nF)														
0.47														
0.68														
1.0														
1.5														
2.2														
3.3														
4.7														
6.8														
10														
15														
22														
33														
47														
68														
100														
150														
220														
330														

Lead configurations

Series	Standard	Reduced	Enlarged	Straight	Double crimped
B32692	15 mm	7.5 / 10 / 12.5 mm	17.5 mm	15 mm	15 mm
B32693	22.5 mm	17.5 / 20 mm	25 mm	22.5 mm	22.5 mm
B32694	27.5 mm	25 mm	–	27.5 mm	27.5 mm

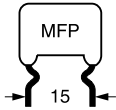
Ordering codes and packing units (lead spacing 15 mm)

V_R	V_{RMS} $f \leq 1$ kHz	C_R	Max. dimensions $w \times h \times l$ mm	Ordering code (composition see below)	Ammo pack pcs./MOQ	Reel pcs./MOQ	Untaped pcs./MOQ
V DC	V AC	nF					
630	300	2.2	6.0 × 11.5 × 19.0	B32692A6222+***	3600	4800	4000
		3.3	6.0 × 11.5 × 19.0	B32692A6332+***	3600	4800	4000
		4.7	6.0 × 11.5 × 19.0	B32692A6472+***	3600	4800	4000
		6.8	6.0 × 11.5 × 19.0	B32692A6682+***	3600	4800	4000
		10	6.0 × 11.5 × 19.0	B32692A6103+***	3600	4800	4000
		15	7.0 × 12.0 × 19.0	B32692A6153+***	3200	4000	4000
		22	8.0 × 13.5 × 19.0	B32692A6223+***	2800	3600	4000
		33	9.5 × 15.5 × 19.0	B32692A6333+***	2400	3200	2000
		47	12.0 × 17.0 × 19.0	B32692A6473+***	1800	2400	2000
1000	400	2.2	6.5 × 12.0 × 19.0	B32692A0222+***	3400	4400	4000
		3.3	7.0 × 12.5 × 19.0	B32692A0332+***	3200	4000	4000
		4.7	7.0 × 12.5 × 19.0	B32692A0472+***	3200	4000	4000
		6.8	7.5 × 14.0 × 19.0	B32692A0682+***	3000	4000	4000
		10	9.0 × 15.5 × 19.0	B32692A0103+***	2400	3200	2000
		15	12.0 × 16.5 × 19.0	B32692A0153+***	1800	2400	2000
1250	450	1.0	6.5 × 11.5 × 19.0	B32692A7102+***	3400	4400	4000
		1.5	6.5 × 11.5 × 19.0	B32692A7152+***	3400	4400	4000
		2.2	6.5 × 12.0 × 19.0	B32692A7222+***	3400	4400	4000
		3.3	7.0 × 12.5 × 19.0	B32692A7332+***	3200	4000	4000
		4.7	7.0 × 12.5 × 19.0	B32692A7472+***	3200	4000	4000
		6.8	7.5 × 14.0 × 19.0	B32692A7682+***	3000	4000	4000
		10	9.0 × 15.5 × 19.0	B32692A7103+***	2400	3200	2000
		15	12.0 × 16.5 × 19.0	B32692A7153+***	1800	2400	2000

MOQ = Minimum Order Quantity, consisting of 4 packing units.

Further E series and intermediate capacitance values on request.

Composition of ordering code

+ = Capacitance tolerance code:

K = ±10%
 J = ±5%
 A = ±3.5%
 on request = ±2.5%

*** = Packaging code:

289 = Ammo pack
 189 = Reel
 010 = Untaped crimped (lead length 6 – 1 mm)
 011 = Untaped crimped (lead length min. 20 mm)
 008 = Untaped straight (lead length 17±3 mm)
 020 = Double crimped (lead length 6 – 1 mm)

Packaging codes for further lead configurations (untaped):

Lead configuration (lead length 6 – 1 mm)	Reduced	Reduced	Reduced	Enlarged
Lead spacing (mm)	7.5 mm	10 mm	12.5 mm	17.5 mm
Packaging code	030	040	050	060

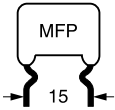
B32692
High pulse (wound)
Ordering codes and packing units (lead spacing 15 mm)

V_R	V_{RMS} $f \leq 1$ kHz	C_R	Max. dimensions $w \times h \times l$ mm	Ordering code (composition see below)	Ammo pack pcs./MOQ	Reel pcs./MOQ	Untaped pcs./MOQ
V DC	V AC	nF					
1600	450	1.0	6.0 × 11.5 × 19.0	B32692A1102+***	3600	4800	4000
		1.5	6.0 × 11.5 × 19.0	B32692A1152+***	3600	4800	4000
		2.2	7.0 × 12.0 × 19.0	B32692A1222+***	3200	4000	4000
		3.3	8.0 × 13.5 × 19.0	B32692A1332+***	2800	3600	4000
		4.7	9.5 × 15.5 × 19.0	B32692A1472+***	2400	3200	4000
		6.8	10.5 × 16.0 × 19.0	B32692A1682+***	2000	2800	2000
		10	12.5 × 17.5 × 19.0	B32692A1103+***	1800	2400	2000
2000	500	0.47	6.5 × 11.5 × 19.0	B32692A2471K***	3400	4400	4000
		0.47	6.5 × 11.5 × 19.0	B32692A2471M***	3400	4400	4000
		0.68	6.5 × 12.5 × 19.0	B32692A2681K***	3400	4400	4000
		0.68	6.5 × 12.5 × 19.0	B32692A2681M***	3400	4400	4000
		1.0	6.5 × 12.5 × 19.0	B32692A2102+***	3400	4400	4000
		1.5	6.5 × 12.5 × 19.0	B32692A2152+***	3400	4400	4000
		2.2	7.0 × 13.5 × 19.0	B32692A2222+***	3200	4000	2000
		3.3	8.5 × 15.0 × 19.0	B32692A2332+***	2600	3400	2000
		4.7	10.5 × 16.0 × 19.0	B32692A2472+***	2000	2800	2000
		6.8	12.5 × 17.5 × 19.0	B32692A2682+***	1800	2400	2000

MOQ = Minimum Order Quantity, consisting of 4 packing units.

Further E series and intermediate capacitance values on request.

Composition of ordering code

+ = Capacitance tolerance code:

K = ±10%
 J = ±5%
 A = ±3.5%
 on request = ±2.5%

*** = Packaging code:

289 = Ammo pack
 189 = Reel
 010 = Untaped crimped (lead length 6 – 1 mm)
 011 = Untaped crimped (lead length min. 20 mm)
 008 = Untaped straight (lead length 17±3 mm)
 020 = Double crimped (lead length 6 – 1 mm)

Packaging codes for further lead configurations (untaped):

Lead configuration (lead length 6 – 1 mm)	Reduced	Reduced	Reduced	Enlarged
Lead spacing (mm)	7.5 mm	10 mm	12.5 mm	17.5 mm
Packaging code	030	040	050	060

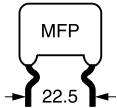
Ordering codes and packing units (lead spacing 22.5 mm)

V_R	V_{RMS} $f \leq 1$ kHz	C_R	Max. dimensions $w \times h \times l$ mm	Ordering code (composition see below)	Ammo pack pcs./MOQ	Reel pcs./MOQ	Untaped pcs./MOQ
V DC	V AC	nF					
630	300	22	6.5 × 12.5 × 27.5	B32693A6223+***	2200	3000	4000
		33	7.0 × 15.0 × 27.5	B32693A6333+***	2000	2800	2000
		47	8.0 × 17.0 × 27.5	B32693A6473+***	1800	2400	2000
		68	9.5 × 17.5 × 27.5	B32693A6683+***	1400	2000	2000
		100	11.5 × 19.5 × 27.5	B32693A6104+***	1200	1600	1000
1250	450	10	7.0 × 15.0 × 27.5	B32693A7103+***	2000	2800	2000
		15	8.0 × 16.0 × 27.5	B32693A7153+***	1800	2400	2000
		22	10.0 × 17.5 × 27.5	B32693A7223+***	1400	2000	2000
		33	12.0 × 19.5 × 27.5	B32693A7333+***	1200	1600	1000
		47	14.0 × 21.0 × 27.5	B32693A7473+***	1000	1400	1000
1600	450	3.3	7.0 × 13.0 × 27.5	B32693A1332+***	2000	2800	4000
		4.7	7.0 × 13.0 × 27.5	B32693A1472+***	2000	2800	4000
		6.8	7.0 × 16.0 × 27.5	B32693A1682+***	2000	2800	2000
		10	8.0 × 17.0 × 27.5	B32693A1103+***	1800	2400	2000
		15	9.5 × 17.5 × 27.5	B32693A1153+***	1400	2000	1000
		22	11.5 × 19.5 × 27.5	B32693A1223+***	1200	1600	1000
		33	15.5 × 22.5 × 27.5	B32693A1333+***	1000	1200	1000

MOQ = Minimum Order Quantity, consisting of 4 packing units.

Further E series and intermediate capacitance values on request.

Composition of ordering code

+ = Capacitance tolerance code:

K =	±10%
J =	±5%
A =	±3.5%
on request =	±2.5%

*** = Packaging code:

289 =	Ammo pack
189 =	Reel
010 =	Untaped crimped (lead length 6 – 1 mm)
011 =	Untaped crimped (lead length min. 20 mm)
008 =	Untaped straight (lead length 17±3 mm)
020 =	Double crimped (lead length 6 – 1 mm)

Packaging codes for further lead configurations (untaped):

Lead configuration (lead length 6 – 1 mm)	Reduced	Reduced	Enlarged
Lead spacing (mm)	17.5 mm	20 mm	25 mm
Packaging code	060	070	080

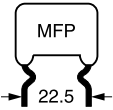
B32693
High pulse (wound)
Ordering codes and packing units (lead spacing 22.5 mm)

V_R	V_{RMS} $f \leq 1$ kHz	C_R	Max. dimensions $w \times h \times l$ mm	Ordering code (composition see below)	Ammo pack pcs./MOQ	Reel pcs./MOQ	Untaped pcs./MOQ
V DC	V AC	nF					
2000	500	2.2	7.0 × 14.0 × 27.5	B32693A2222+***	2000	2800	4000
		3.3	7.0 × 14.0 × 27.5	B32693A2332+***	2000	2800	4000
		4.7	7.0 × 15.5 × 27.5	B32693A2472+***	2000	2800	2000
		6.8	9.0 × 16.5 × 27.5	B32693A2682+***	1600	2200	2000
		10	10.5 × 17.5 × 27.5	B32693A2103+***	1400	1800	1000
		15	13.0 × 20.5 × 27.5	B32693A2153+***	1000	1400	1000
		22	15.5 × 22.5 × 27.5	B32693A2223+***	800	1200	1000
2500	750	1.0	7.5 × 14.0 × 27.5	B32693A3102+***	1800	2600	4000
		1.5	7.5 × 15.0 × 27.5	B32693A3152+***	1800	2600	4000
		2.2	8.0 × 16.0 × 27.5	B32693A3222+***	1800	2400	2000
		3.3	9.5 × 16.0 × 27.5	B32693A3332+***	1400	2000	2000
		4.7	10.0 × 18.5 × 27.5	B32693A3472+***	1400	2000	2000
		6.8	12.0 × 20.5 × 27.5	B32693A3682+***	1200	1600	1000
		10	14.0 × 23.0 × 27.5	B32693A3103+***	1000	1400	1000
		15	17.0 × 26.0 × 27.5	B32693A3153+***	800	1200	800

MOQ = Minimum Order Quantity, consisting of 4 packing units.
Further E series and intermediate capacitance values on request.

Composition of ordering code

+ = Capacitance tolerance code:

K = ±10%
J = ±5%
A = ±3.5%
on request = ±2.5%

*** = Packaging code:

289 = Ammo pack
189 = Reel
010 = Untaped crimped (lead length 6 – 1 mm)
011 = Untaped crimped (lead length min. 20 mm)
008 = Untaped straight (lead length 17±3 mm)
020 = Double crimped (lead length 6 – 1 mm)

Packaging codes for further lead configurations (untaped):

Lead configuration (lead length 6 – 1 mm)	Reduced	Reduced	Enlarged
Lead spacing (mm)	17.5 mm	20 mm	25 mm
Packaging code	060	070	080

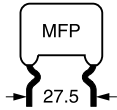
Ordering codes and packing units (lead spacing 27.5 mm)

V_R	V_{RMS} $f \leq 1$ kHz	C_R	Max. dimensions $w \times h \times l$	Ordering code (composition see below)	Untaped
V DC	V AC	nF	mm		pcs./MOQ
630	300	100	9.5 × 18.0 × 32.5	B32694A6104+***	1000
		150	12.0 × 22.0 × 32.5	B32694A6154+***	800
		220	13.5 × 22.5 × 32.5	B32694A6224+***	800
		330	16.0 × 25.5 × 32.5	B32694A6334+***	600
1250	450	33	9.5 × 18.0 × 32.5	B32694A7333+***	1000
		47	11.5 × 20.0 × 32.5	B32694A7473+***	1000
		68	13.0 × 23.0 × 32.5	B32694A7683+***	800
		100	16.0 × 26.0 × 32.5	B32694A7104+***	600
1600	450	10	8.5 × 15.5 × 32.5	B32694A1103+***	2000
		15	8.5 × 17.0 × 32.5	B32694A1153+***	2000
		22	10.0 × 18.5 × 32.5	B32694A1223+***	1000
		33	12.0 × 22.0 × 32.5	B32694A1333+***	1000
		47	14.0 × 22.5 × 32.5	B32694A1473+***	800
		68	16.0 × 25.5 × 32.5	B32694A1683+***	600
2000	500	10	8.5 × 17.0 × 32.5	B32694A2103+***	2000
		15	10.0 × 20.0 × 32.5	B32694A2153+***	1000
		22	12.0 × 22.0 × 32.5	B32694A2223+***	1000
		33	15.0 × 25.0 × 32.5	B32694A2333+***	800

MOQ = Minimum Order Quantity, consisting of 4 packing units.
Further E series and intermediate capacitance values on request.

Composition of ordering code

+ = Capacitance tolerance code:

K = ±10%
J = ±5%
A = ±3.5%
on request = ±2.5%

*** = Packaging code:

010 = Untaped crimped (lead length 6 – 1 mm)
011 = Untaped crimped (lead length min. 20 mm)
008 = Untaped straight (lead length 17±3 mm)
020 = Double crimped (lead length 6 – 1 mm)

Packaging codes for further lead configurations (untaped):

Lead configuration (lead length 6 – 1 mm)	Reduced
Lead spacing (mm)	25 mm
Packaging code	090

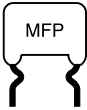

B32692 ... B32694

High pulse (wound)

Technical data

Operating temperature range	Max. operating temperature $T_{op,max}$	+110 °C	
	Upper category temperature T_{max}	+100 °C	
	Lower category temperature T_{min}	-55 °C	
	Rated temperature T_R	+85 °C	
Dissipation factor $\tan \delta$ at 20 °C (upper limit values)	1.0 · 10 ⁻³ (at 10 kHz)		
	Insulation resistance R_{ins} at 20 °C, rel. humidity ≤ 65% (minimum as-delivered values)	100 GΩ	
DC test voltage	2.0 · V_R , 2 s		
Category voltage V_C (continuous operation with V_{DC} or V_{AC} at $f \leq 1$ kHz)	T_A (°C)	DC voltage derating	AC voltage derating
	$T_A \leq 85$ $85 < T_A \leq 100$	$V_C = V_R$ $V_C = V_R \cdot (165 - T_A)/80$	$V_{C,RMS} = V_{RMS}$ $V_{C,RMS} = V_{RMS} \cdot (165 - T_A)/80$
Operating voltage V_{op} for short operating periods (V_{DC} or V_{AC} at $f \leq 1$ kHz)	T_A (°C)	DC voltage (max. hours)	AC voltage (max. hours)
	$T_A \leq 85$ $85 < T_A \leq 100$	$V_{op} = 1.25 \cdot V_C$ (2000h) $V_{op} = 1.25 \cdot V_C$ (1000h)	$V_{op} = 1.0 \cdot V_{C,RMS}$ (2000h) $V_{op} = 1.0 \cdot V_{C,RMS}$ (1000h)
Damp heat test	56 days/40 °C/93% relative humidity		
Limit values after damp heat test	Capacitance change $ \Delta C/C $	≤ 2%	
	Dissipation factor change $\Delta \tan \delta$	≤ 1.0 · 10 ⁻³ (at 10 kHz)	
	Insulation resistance R_{ins}	≥ 50% of minimum as-delivered values	
Reliability:			
Failure rate λ	2 fit (≤ 2 · 10 ⁻⁹ /h) at 0.5 · V_R , 40 °C		
Service life t_{SL}	200 000 h at 1.0 · V_R , 40 °C		
	For conversion to other operating conditions and temperatures, refer to chapter "Quality, 2 Reliability".		
Failure criteria:			
Total failure	Short circuit or open circuit		
Failure due to variation of parameters	Capacitance change $ \Delta C/C $	> 10%	
	Dissipation factor $\tan \delta$	> 4 · upper limit value	
	Insulation resistance R_{ins}	< 1500 MΩ	



Characteristic voltages V_{DC} , V_{AC} , V_{pp}

V_{DC} V	V_{AC} V	V_{pp} V
630	300	560
1000	400	800
1250	450	1000
1600	450	1200
2000	500	1400
2500	750	1750



B32692 ... B32694

High pulse (wound)

Pulse handling capability

"dV/dt" represents the maximum permissible voltage change per unit of time for non-sinusoidal voltages, expressed in V/ μ s.

"k₀" represents the maximum permissible pulse characteristic of the waveform applied to the capacitor, expressed in V²/ μ s.

Note:

The values of dV/dt and k₀ provided below must not be exceeded in order to avoid damaging the capacitor.

dV/dt values

Lead spacing		15 mm	22.5 mm	27.5 mm
V _R	V _{RMS}	dV/dt in V/ μ s		
V DC	V AC			
630	300	5 000	3 000	2 000
1000	400	8 000	–	–
1250	450	12 000	7 000	4 500
1600	450	14 000	9 000	5 500
2000	500	17 000	12 000	7 000
2500	750	–	14 000	–

k₀ values

Lead spacing		15 mm	22.5 mm	27.5 mm
V _R	V _{RMS}	k ₀ in V ² / μ s		
V DC	V AC			
630	300	6 300 000	3 800 000	2 500 000
1000	400	16 000 000	–	–
1250	450	30 000 000	17 500 000	11 000 000
1600	450	45 000 000	29 000 000	17 500 000
2000	500	68 000 000	48 000 000	28 000 000
2500	750	–	59 000 000	–

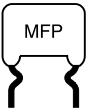

Impedance Z versus frequency f

(typical values)

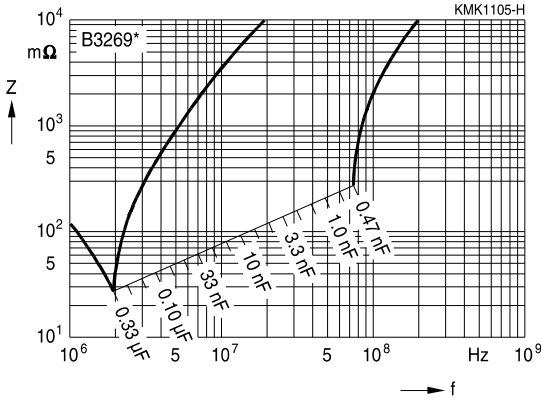

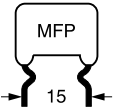

B32692

High pulse (wound)

Permissible AC voltage V_{RMS} versus frequency f (for sinusoidal waveforms, $T_A \leq 90^\circ C$)

For $T_A > 90^\circ C$, please refer to "General technical information", section 3.2.3.

Lead spacing 15 mm

630 V DC/300 V AC

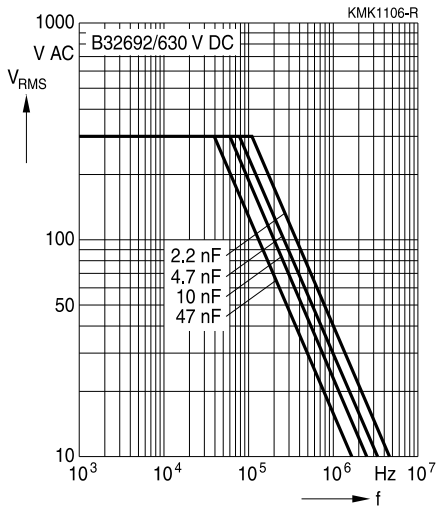

1000 V DC/400 V AC

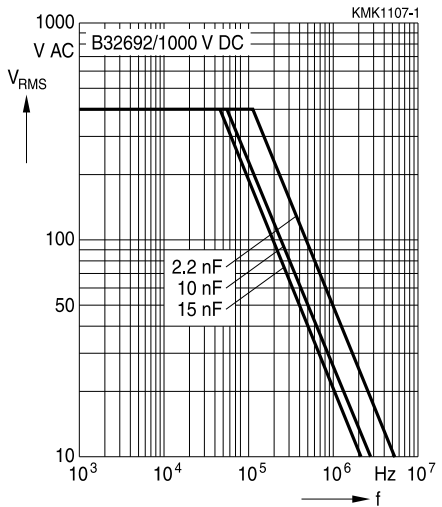

1250 V DC/450 V AC

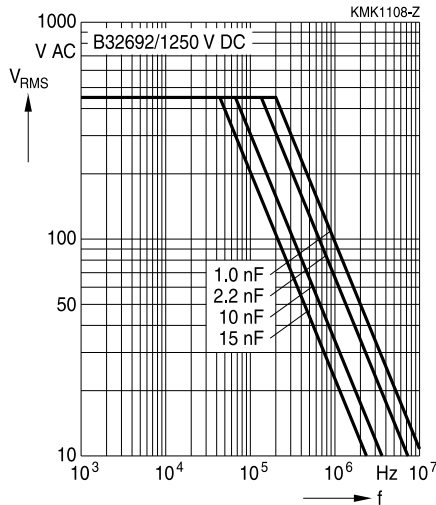

1600 V DC/450 V AC

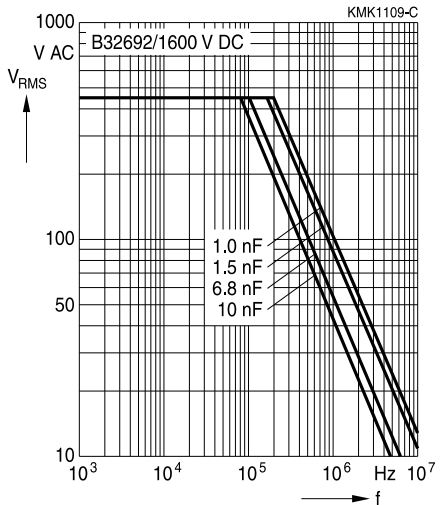

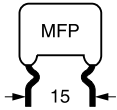

Permissible AC voltage V_{RMS} versus frequency f (for sinusoidal waveforms, $T_A \leq 90\text{ }^\circ\text{C}$)

For $T_A > 90\text{ }^\circ\text{C}$, please refer to "General technical information", section 3.2.3.

Lead spacing 15 mm

2000 V DC/500 V AC

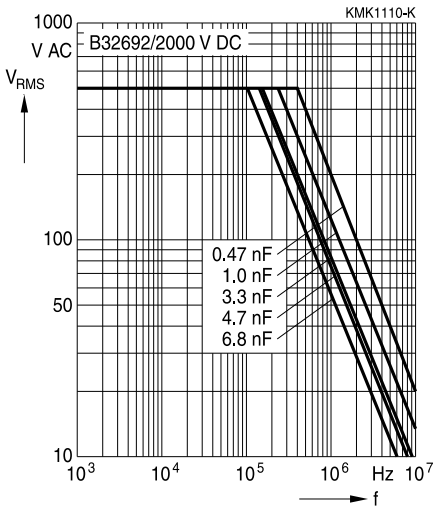

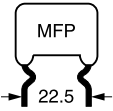

B32693

High pulse (wound)

Permissible AC voltage V_{RMS} versus frequency f (for sinusoidal waveforms, $T_A \leq 90^\circ C$)
 For $T_A > 90^\circ C$, please refer to "General technical information", section 3.2.3.

Lead spacing 22.5 mm

630 V DC/300 V AC

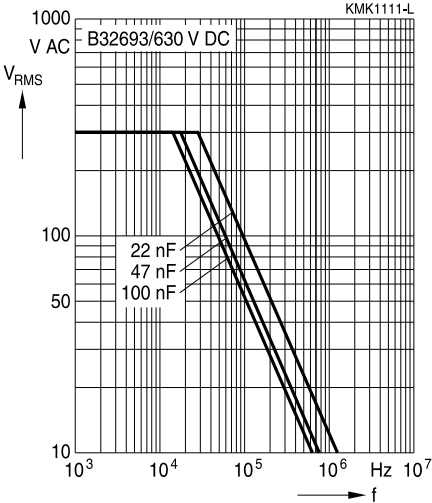

1250 V DC/450 V AC

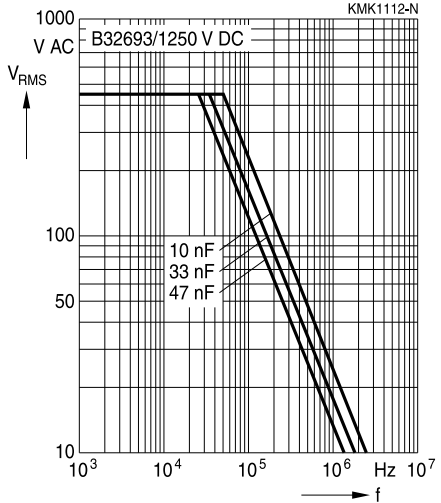

1600 V DC/450 V AC

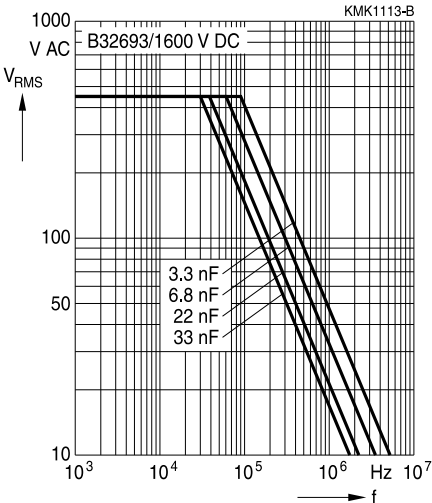

2000 V DC/500 V AC

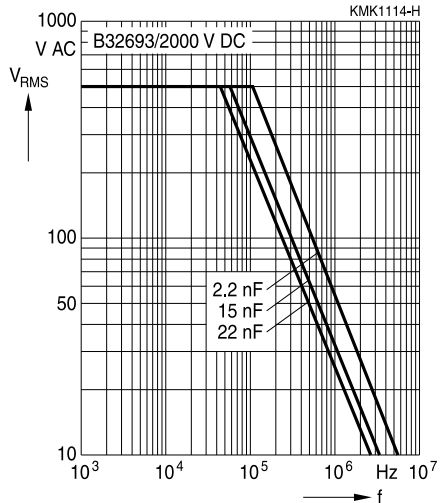

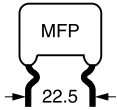

Permissible AC voltage V_{RMS} versus frequency f (for sinusoidal waveforms, $T_A \leq 90\text{ }^\circ\text{C}$)
 For $T_A > 90\text{ }^\circ\text{C}$, please refer to "General technical information", section 3.2.3.

Lead spacing 22.5 mm

2500 V DC/750 V AC

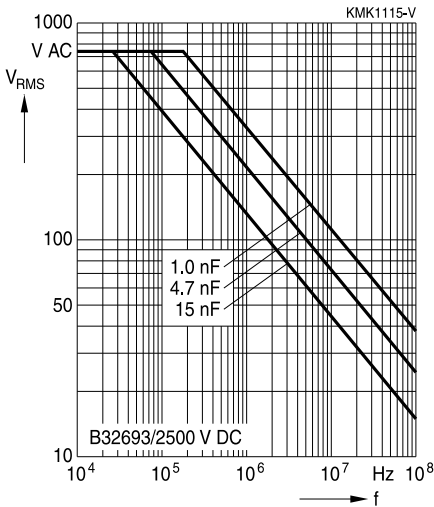

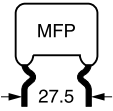

B32694

High pulse (wound)

Permissible AC voltage V_{RMS} versus frequency f (for sinusoidal waveforms, $T_A \leq 90^\circ C$)

For $T_A > 90^\circ C$, please refer to "General technical information", section 3.2.3.

Lead spacing 27.5 mm

630 V DC/300 V AC

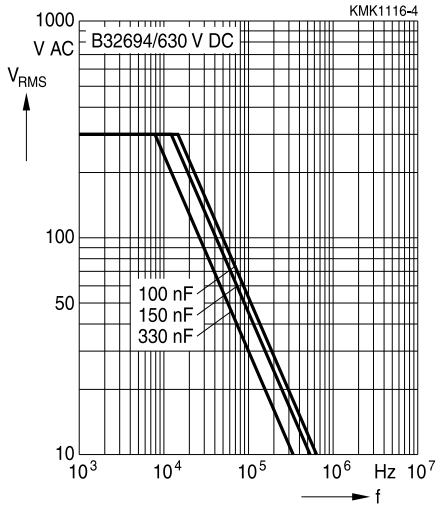

1250 V DC/450 V AC

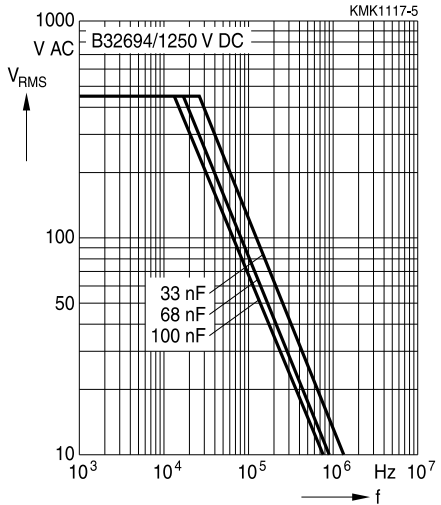

1600 V DC/450 V AC

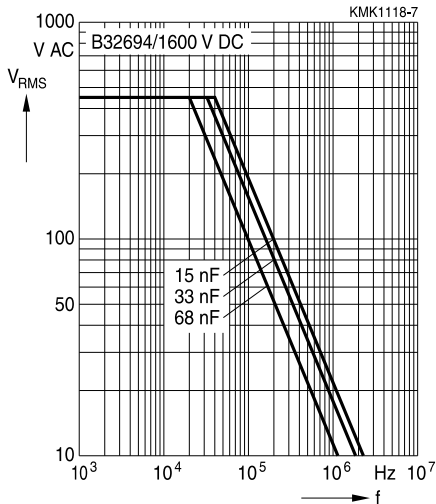

2000 V DC/500 V AC

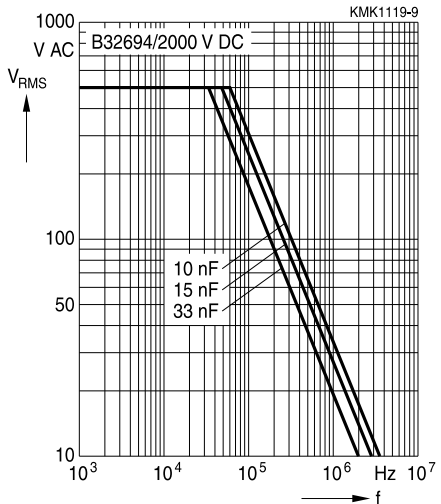

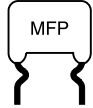

Mounting guidelines

1 Soldering

1.1 Solderability of leads

The solderability of terminal leads is tested to IEC 60068-2-20, test Ta, method 1.

Before a solderability test is carried out, terminals are subjected to accelerated ageing (to IEC 60068-2-2, test Ba: 4 h exposure to dry heat at 155 °C). Since the ageing temperature is far higher than the upper category temperature of the capacitors, the terminal wires should be cut off from the capacitor before the ageing procedure to prevent the solderability being impaired by the products of any capacitor decomposition that might occur.

Solder bath temperature	235 ±5 °C
Soldering time	2.0 ±0.5 s
Immersion depth	2.0 +0/-0.5 mm from capacitor body or seating plane
Evaluation criteria:	
Visual inspection	Wetting of wire surface by new solder ≥90%, free-flowing solder

1.2 Resistance to soldering heat

Resistance to soldering heat is tested to IEC 60068-2-20, test Tb, method 1A.

Conditions:

Series	Solder bath temperature	Soldering time
MKT boxed (except 2.5 × 6.5 × 7.2 mm) coated uncoated (lead spacing > 10 mm)	260 ±5 °C	10 ±1 s
MFP MKP (lead spacing > 7.5 mm)		
MKT boxed (case 2.5 × 6.5 × 7.2 mm)		5 ±1 s
MKP (lead spacing ≤ 7.5 mm)		< 4 s
MKT uncoated (lead spacing ≤ 10 mm) insulated (B32559)		recommended soldering profile for MKT uncoated (lead spacing ≤ 10 mm) and insulated (B32559)



B32692 ... B32694

High pulse (wound)

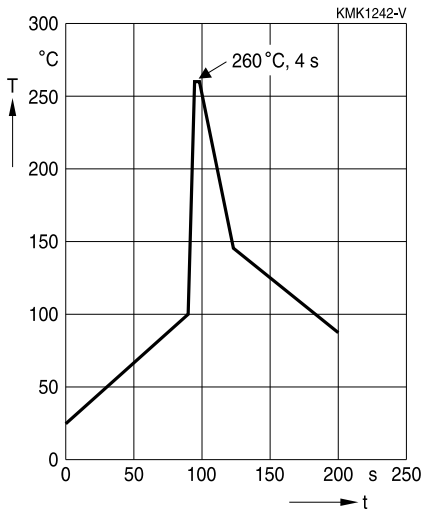

Immersion depth	2.0 +0/−0.5 mm from capacitor body or seating plane
Shield	Heat-absorbing board, (1.5 ±0.5) mm thick, between capacitor body and liquid solder
Evaluation criteria:	
Visual inspection	No visible damage
$\Delta C/C_0$	2% for MKT/MKP/MFP 5% for EMI suppression capacitors
$\tan \delta$	As specified in sectional specification

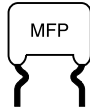

1.3 General notes on soldering

Permissible heat exposure loads on film capacitors are primarily characterized by the upper category temperature T_{max} . Long exposure to temperatures above this type-related temperature limit can lead to changes in the plastic dielectric and thus change irreversibly a capacitor's electrical characteristics. For short exposures (as in practical soldering processes) the heat load (and thus the possible effects on a capacitor) will also depend on other factors like:

- Pre-heating temperature and time
- Forced cooling immediately after soldering
- Terminal characteristics:
 - diameter, length, thermal resistance, special configurations (e.g. crimping)
- Height of capacitor above solder bath
- Shadowing by neighboring components
- Additional heating due to heat dissipation by neighboring components
- Use of solder-resist coatings

The overheating associated with some of these factors can usually be reduced by suitable countermeasures. For example, if a pre-heating step cannot be avoided, an additional or reinforced cooling process may possibly have to be included.

EPCOS recommends the following conditions:

- Pre-heating with a maximum temperature of 110 °C
- Temperature inside the capacitor should not exceed the following limits:
 - MKP/MFP 110 °C
 - MKT 160 °C
- When SMD components are used together with leaded ones, the leaded film capacitors should not pass into the SMD adhesive curing oven. The leaded components should be assembled after the SMD curing step.
- Leaded film capacitors are not suitable for reflow soldering.

Uncoated capacitors

For uncoated MKT capacitors with lead spacings ≤ 10 mm (B32560/B32561) the following measures are recommended:

- pre-heating to not more than 110 °C in the preheater phase
- rapid cooling after soldering



B32692 ... B32694

High pulse (wound)

Cautions and warnings

- Do not exceed the upper category temperature (UCT).
- Do not apply any mechanical stress to the capacitor terminals.
- Avoid any compressive, tensile or flexural stress.
- Do not move the capacitor after it has been soldered to the PC board.
- Do not pick up the PC board by the soldered capacitor.
- Do not place the capacitor on a PC board whose PTH hole spacing differs from the specified lead spacing.
- Do not exceed the specified time or temperature limits during soldering.
- Avoid external energy inputs, such as fire or electricity.
- Avoid overload of the capacitors.

The table below summarizes the safety instructions that must always be observed. A detailed description can be found in the relevant sections of the chapters "General technical information" and "Mounting guidelines".

Topic	Safety information	Reference chapter "General technical information"
Storage conditions	Make sure that capacitors are stored within the specified range of time, temperature and humidity conditions.	4.5 "Storage conditions"
Flammability	Avoid external energy, such as fire or electricity (passive flammability), avoid overload of the capacitors (active flammability) and consider the flammability of materials.	5.3 "Flammability"
Resistance to vibration	Do not exceed the tested ability to withstand vibration. The capacitors are tested to IEC 60068-2-6. EPCOS offers film capacitors specially designed for operation under more severe vibration regimes such as those found in automotive applications. Consult our catalog "Film Capacitors for Automotive Electronics".	5.2 "Resistance to vibration"

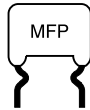

Topic	Safety information	Reference chapter "Mounting guidelines"
Soldering	Do not exceed the specified time or temperature limits during soldering.	1 "Soldering"
Cleaning	Use only suitable solvents for cleaning capacitors.	2 "Cleaning"
Embedding of capacitors in finished assemblies	When embedding finished circuit assemblies in plastic resins, chemical and thermal influences must be taken into account. Caution: Consult us first, if you also wish to embed other uncoated component types!	3 "Embedding of capacitors in finished assemblies"

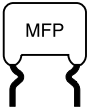

B32692 ... B32694

High pulse (wound)

Symbols and terms

Symbol	English	German
α	Heat transfer coefficient	Wärmeübergangszahl
α_C	Temperature coefficient of capacitance	Temperaturkoeffizient der Kapazität
A	Capacitor surface area	Kondensatoroberfläche
β_C	Humidity coefficient of capacitance	Feuchtekoeffizient der Kapazität
C	Capacitance	Kapazität
C_R	Rated capacitance	Nennkapazität
ΔC	Absolute capacitance change	Absolute Kapazitätsänderung
$\Delta C/C$	Relative capacitance change (relative deviation of actual value)	Relative Kapazitätsänderung (relative Abweichung vom Ist-Wert)
$\Delta C/C_R$	Capacitance tolerance (relative deviation from rated capacitance)	Kapazitätstoleranz (relative Abweichung vom Nennwert)
dt	Time differential	Differentielle Zeit
Δt	Time interval	Zeitintervall
ΔT	Absolute temperature change (self-heating)	Absolute Temperaturänderung (Selbsterwärmung)
$\Delta \tan \delta$	Absolute change of dissipation factor	Absolute Änderung des Verlustfaktors
ΔV	Absolute voltage change	Absolute Spannungsänderung
dV/dt	Time differential of voltage function (rate of voltage rise)	Differentielle Spannungsänderung (Spannungsflankensteilheit)
$\Delta V/\Delta t$	Voltage change per time interval	Spannungsänderung pro Zeitintervall
E	Activation energy for diffusion	Aktivierungsenergie zur Diffusion
ESL	Self-inductance	Eigeninduktivität
ESR	Equivalent series resistance	Ersatz-Serienwiderstand
f	Frequency	Frequenz
f_1	Frequency limit for reducing permissible AC voltage due to thermal limits	Grenzfrequenz für thermisch bedingte Reduzierung der zulässigen Wechselspannung
f_2	Frequency limit for reducing permissible AC voltage due to current limit	Grenzfrequenz für strombedingte Reduzierung der zulässigen Wechselspannung
f_r	Resonant frequency	Resonanzfrequenz
F_D	Thermal acceleration factor for diffusion	Therm. Beschleunigungsfaktor zur Diffusion
F_T	Derating factor	Deratingfaktor
i	Current (peak)	Stromspitze
I_C	Category current (max. continuous current)	Kategoriestrom (max. Dauerstrom)

Symbol	English	German
I_{RMS}	(Sinusoidal) alternating current, root-mean-square value	(Sinusförmiger) Wechselstrom
i_z	Capacitance drift	Inkonstanz der Kapazität
k_0	Pulse characteristic	Impuls Kennwert
L_S	Series inductance	Serieninduktivität
λ	Failure rate	Ausfallrate
λ_0	Constant failure rate during useful service life	Konstante Ausfallrate in der Nutzungsphase
λ_{test}	Failure rate, determined by tests	Experimentell ermittelte Ausfallrate
P_{diss}	Dissipated power	Abgegebene Verlustleistung
P_{gen}	Generated power	Erzeugte Verlustleistung
Q	Heat energy	Wärmeenergie
ρ	Density of water vapor in air	Dichte von Wasserdampf in Luft
R	Universal molar constant for gases	Allg. Molarkonstante für Gas
R	Ohmic resistance of discharge circuit	Ohmscher Widerstand des Entladekreises
R_i	Internal resistance	Innenwiderstand
R_{ins}	Insulation resistance	Isolationswiderstand
R_P	Parallel resistance	Parallelwiderstand
R_S	Series resistance	Serienwiderstand
S	severity (humidity test)	Schärfegrad (Feuchtest)
t	Time	Zeit
T	Temperature	Temperatur
τ	Time constant	Zeitkonstante
$\tan \delta$	Dissipation factor	Verlustfaktor
$\tan \delta_D$	Dielectric component of dissipation factor	Dielektrischer Anteil des Verlustfaktors
$\tan \delta_P$	Parallel component of dissipation factor	Parallelanteil des Verlustfaktors
$\tan \delta_S$	Series component of dissipation factor	Serienanteil des Verlustfaktors
T_A	Ambient temperature	Umgebungstemperatur
T_{max}	Upper category temperature	Obere Kategorietemperatur
T_{min}	Lower category temperature	Untere Kategorietemperatur
t_{OL}	Operating life at operating temperature and voltage	Betriebszeit bei Betriebstemperatur und -spannung
T_{op}	Operating temperature	Betriebstemperatur
T_R	Rated temperature	Nenntemperatur
T_{ref}	Reference temperature	Referenztemperatur
t_{SL}	Reference service life	Referenz-Lebensdauer
V_{AC}	AC voltage	Wechselspannung

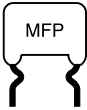

B32692 ... B32694

High pulse (wound)

Symbol	English	German
V_C	Category voltage	Kategoriespannung
$V_{C,RMS}$	Category AC voltage	(Sinusförmige) Kategorie-Wechselspannung
V_{CD}	Corona-discharge onset voltage	Teilentlade-Einsatzspannung
V_{ch}	Charging voltage	Ladespannung
V_{DC}	DC voltage	Gleichspannung
V_{FB}	Fly-back capacitor voltage	Spannung (Flyback)
V_i	Input voltage	Eingangsspannung
V_o	Output voltage	Ausgangssspannung
V_{op}	Operating voltage	Betriebsspannung
V_p	Peak pulse voltage	Impuls-Spitzenspannung
V_{pp}	Peak-to-peak voltage Impedance	Spannungshub
V_R	Rated voltage	Nennspannung
\hat{V}_R	Amplitude of rated AC voltage	Amplitude der Nenn-Wechselspannung
V_{RMS}	(Sinusoidal) alternating voltage, root-mean-square value	(Sinusförmige) Wechselspannung
V_{SC}	S-correction voltage	Spannung bei Anwendung "S-correction"
V_{sn}	Snubber capacitor voltage	Spannung bei Anwendung "Beschaltung"
Z	Impedance	Scheinwiderstand
e	Lead spacing	Rastermaß

Important notes

The following applies to all products named in this publication:

1. Some parts of this publication contain **statements about the suitability of our products for certain areas of application**. These statements are based on our knowledge of typical requirements that are often placed on our products in the areas of application concerned. We nevertheless expressly point out **that such statements cannot be regarded as binding statements about the suitability of our products for a particular customer application**. As a rule we are either unfamiliar with individual customer applications or less familiar with them than the customers themselves. For these reasons, it is always ultimately incumbent on the customer to check and decide whether a product with the properties described in the product specification is suitable for use in a particular customer application.
2. We also point out that **in individual cases, a malfunction of electronic components or failure before the end of their usual service life cannot be completely ruled out in the current state of the art, even if they are operated as specified**. In customer applications requiring a very high level of operational safety and especially in customer applications in which the malfunction or failure of an electronic component could endanger human life or health (e.g. in accident prevention or life-saving systems), it must therefore be ensured by means of suitable design of the customer application or other action taken by the customer (e.g. installation of protective circuitry or redundancy) that no injury or damage is sustained by third parties in the event of malfunction or failure of an electronic component.
3. **The warnings, cautions and product-specific notes must be observed.**
4. In order to satisfy certain technical requirements, **some of the products described in this publication may contain substances subject to restrictions in certain jurisdictions (e.g. because they are classed as hazardous)**. Useful information on this will be found in our Material Data Sheets on the Internet (www.tdk-electronics.tdk.com/material). Should you have any more detailed questions, please contact our sales offices.
5. We constantly strive to improve our products. Consequently, **the products described in this publication may change from time to time**. The same is true of the corresponding product specifications. Please check therefore to what extent product descriptions and specifications contained in this publication are still applicable before or when you place an order.

We also **reserve the right to discontinue production and delivery of products**. Consequently, we cannot guarantee that all products named in this publication will always be available. The aforementioned does not apply in the case of individual agreements deviating from the foregoing for customer-specific products.
6. Unless otherwise agreed in individual contracts, **all orders are subject to our General Terms and Conditions of Supply**.
7. **Our manufacturing sites serving the automotive business apply the IATF 16949 standard**. The IATF certifications confirm our compliance with requirements regarding the quality management system in the automotive industry. Referring to customer requirements and customer specific requirements ("CSR") TDK always has and will continue to have the policy of respecting individual agreements. Even if IATF 16949 may appear to support the acceptance of unilateral requirements, we hereby like to emphasize that **only requirements mutually agreed upon can and will be implemented in our Quality Management System**. For clarification purposes we like to point out that obligations from IATF 16949 shall only become legally binding if individually agreed upon.
8. The trade names EPCOS, CeraCharge, CeraDiode, CeraLink, CeraPad, CeraPlas, CSMP, CTVS, DeltaCap, DigiSiMic, ExoCore, FilterCap, FormFit, LeaXield, MiniBlue, MiniCell, MKD, MKK, MotorCap, PCC, PhaseCap, PhaseCube, PhaseMod, PhiCap, PowerHap, PQSine, PQvar, SIFERRIT, SIFI, SIKOREL, SilverCap, SIMDAD, SiMic, SIMID, SineFormer, SIOV, ThermoFuse, WindCap are **trademarks registered or pending** in Europe and in other countries. Further information will be found on the Internet at www.tdk-electronics.tdk.com/trademarks.