



CeraLink

Capacitors for fast-switching semiconductors

Series/Type: SMD 2220 series
Ordering code: B58043*
Date: 2021-06-14
Version: 2.0

Applications

- Power converters and inverters
- DC link / snubber capacitor for power converters and inverters

Features

- High ripple current capability
- High temperature robustness
- Low equivalent serial inductance (ESL)
- Low equivalent serial resistance (ESR)
- Low power loss
- Low dielectric absorption
- Optimized for high frequencies up to several MHz
- Increasing capacitance with DC bias up to operating voltage
- High capacitance density
- Minimized dielectric loss at high temperatures
- Available with soft termination
- Qualification based on AEC-Q200
- RoHS-compatible

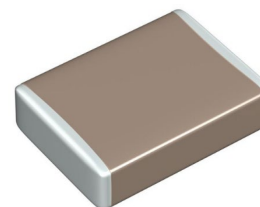

Construction

- Multilayer technology
- PLZT ceramic (lead lanthanum zirconium titanate)
- Copper inner electrodes
- Nickel barrier termination (Cu/Ni/Sn), recommended for lead-free soldering and compatible with tin/lead solder
- Conductive resin layer between Cu and Ni layer (soft termination only)
- Recommended for reflow soldering

General technical data

Dissipation factor	$\tan \delta$	< 0.025	
Insulation resistance	$R_{ins, typ}^{1)}$	> 10	G Ω
Operating device temperature	T_{device}	-40 ... +150	°C

¹⁾ Typical insulation resistance, measured at operating voltage V_{op} and measurement time ≥ 240 s, +25 °C

Electrical specifications and ordering code

Ordering code	Termination	V _{pk, max} V	V _R V	V _{op} V	C _{nom, typ} nF	C _{eff, typ} nF	C ₀ nF	C _{0, typ} ^{unpoled} nF
B58043I5254M052	Standard	650	500	400	250	150	85 ±20%	50
B58043E5254M052	Soft							

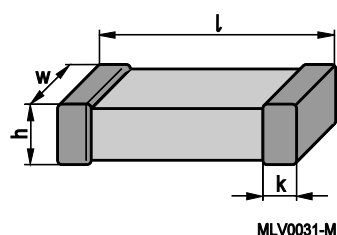
Dimensional drawings

Dimensions in mm

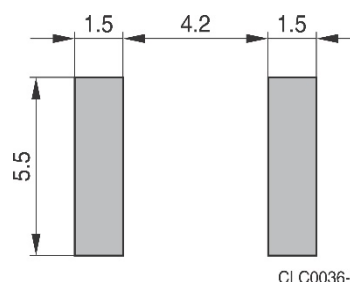
Recommended solder pad layout

Case size EIA / mm	l	w	h	k
2220 / 5750	5.7 ±0.4	5.0 ±0.4	1.4 ±0.2	0.25 ... 1.00

Typical values as a design reference for CeraLink applications

Ordering code	ESR	ESR	ESL	I _{op} ²⁾	I _{op} ²⁾
	0 V _{DC} 0.5 V _{AC,RMS} @1 kHz T _{amb} = 25 °C	0 V _{DC} 0.5 V _{AC,RMS} @1 MHz T _{amb} = 25 °C		100 kHz T _{amb} = 85 °C	100 kHz T _{amb} = 105 °C
	Ω	mΩ	nH	A _{RMS}	A _{RMS}
B58043I5254M052	15	40	3	5.0	4.3
B58043E5254M052				4.5	3.8

²⁾ Normal operating current without forced cooling at T_{device} = +150°C. Higher values permissible at reduced lifetime.

Polarity and marking of components

In contrast to other CeraLink® types, CeraLink 2220 components do not have a polarity marking.

 Note that after reflow soldering, the components are usually unpoled due to temperature effects, where the re-poling happens automatically after switching on the operating voltage V_{op}.

 If components are operated below the specified operating voltage V_{op}, a first time poling is required to establish the specified capacitance values, see our *CeraLink Technical Guide* for further details.

Typical characteristics as a function of temperature and voltage
(0.5 V_{AC,RMS}, frequency = 1 kHz)

All given temperatures are device temperatures.

The curves show the relative changes of the capacitance, dissipation factor and ESR. The 100% values correspond to tanδ, resp. C_{eff,typ} & ESR_{1kHz} which are given on page 2, resp. page 3 of this data sheet.

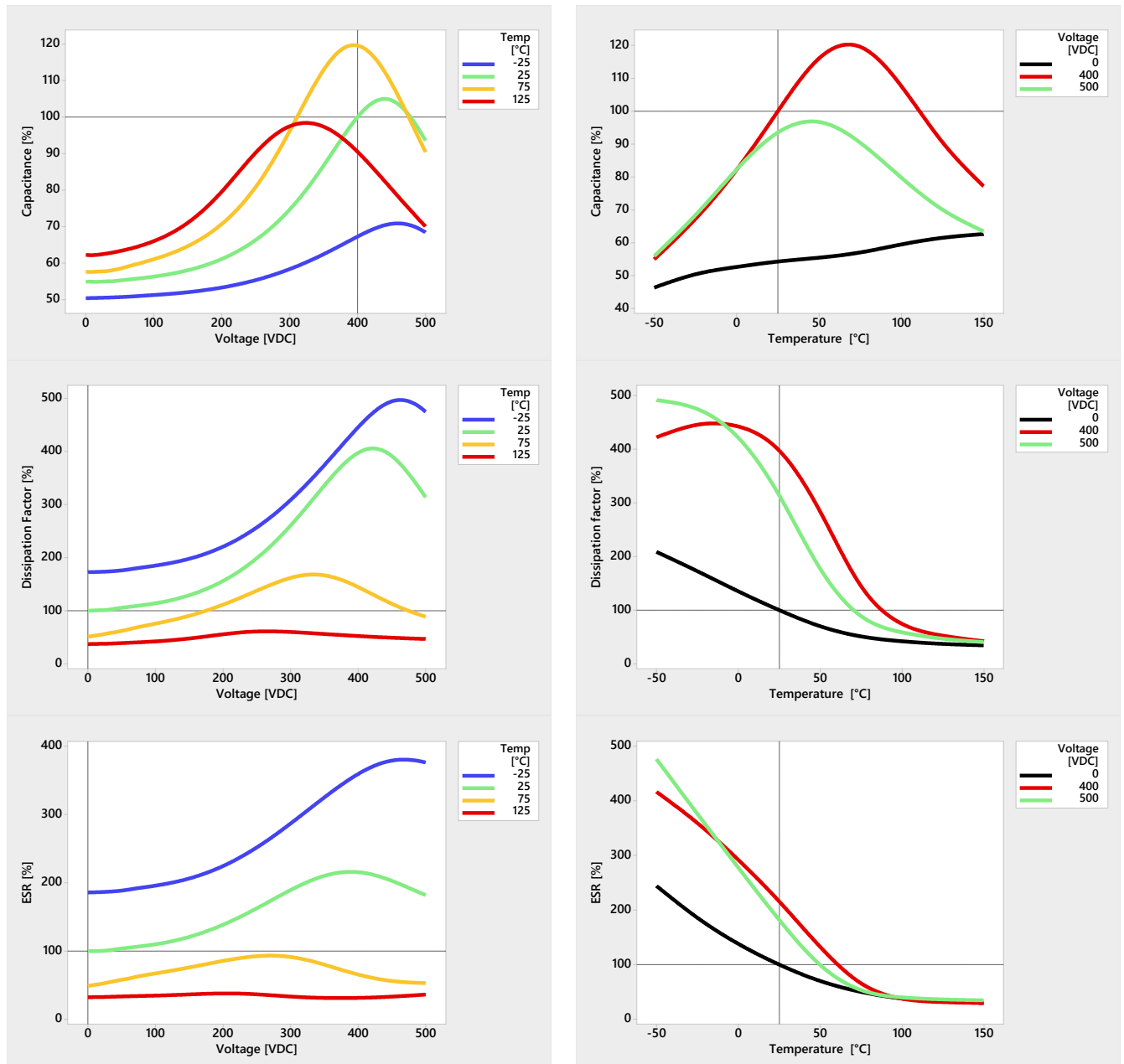

Depolarization over time

The capacitor shows a decrease of capacitance over time if no voltage is applied. The typical rate is about 2.5% per logarithmic decade in hours. This effect is completely reversible when V_{op} is applied.

Further typical electrical characteristics as a design reference for CeraLink applications

Typical capacitance values as a function of voltage (B58043*5254M052)

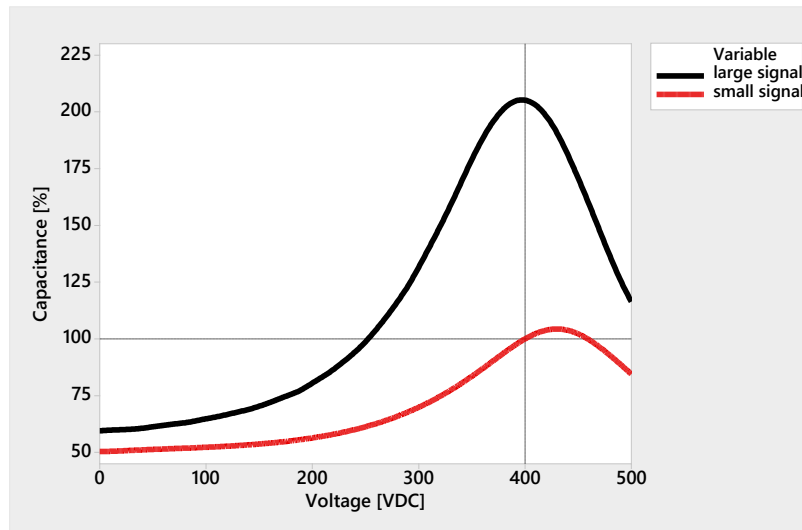

Large signal capacitance:

Quasistatic (slow voltage variation voltage), 25 °C

The nominal capacitance C_{nom} is defined as the large signal capacitance at V_{op} .

See glossary for further information.

Small signal capacitance:

0.5 $V_{AC,RMS}$, 1 kHz, 25 °C

The effective capacitance C_{eff} is defined as the small signal capacitance at V_{op} .

Typical impedance and ESR as a function of frequency (B58043*5254M052)

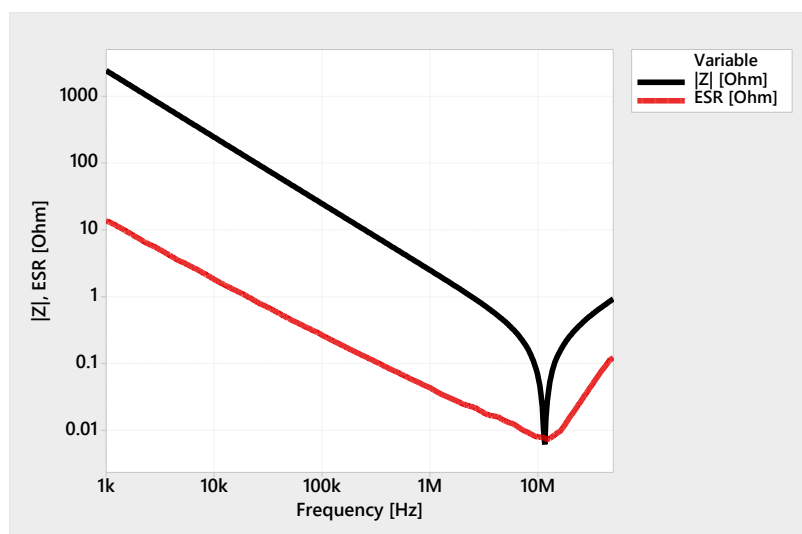

$V_{DC} = 0 V$, 0.5 $V_{AC,RMS}$, $T_{device} = 25 °C$

Typical permissible current as a function of frequency

Standard termination type (B58043I5254M052)

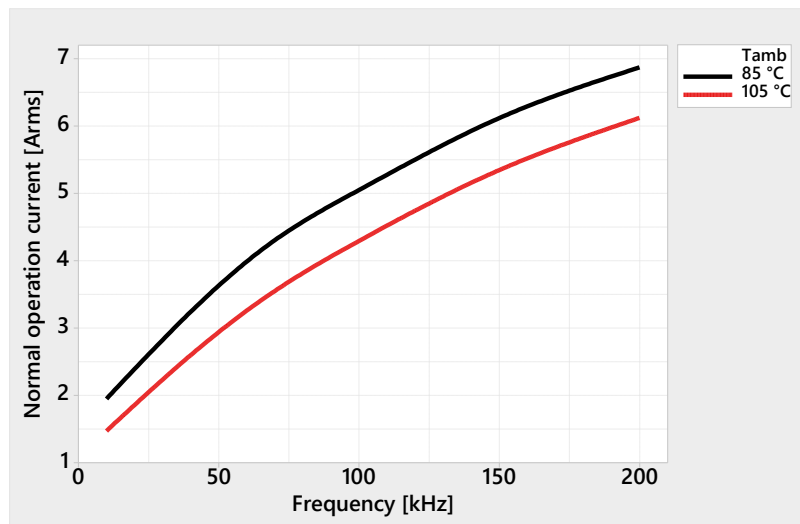

Measurement performed at V_{op} without forced cooling.

The values correspond to a device temperature of 150 °C.

Note that with additional cooling the typical permissible current can be significantly higher.

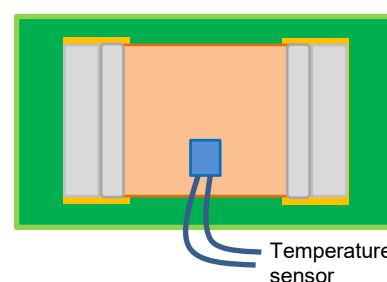

Soft termination type (B58043E5254M052)

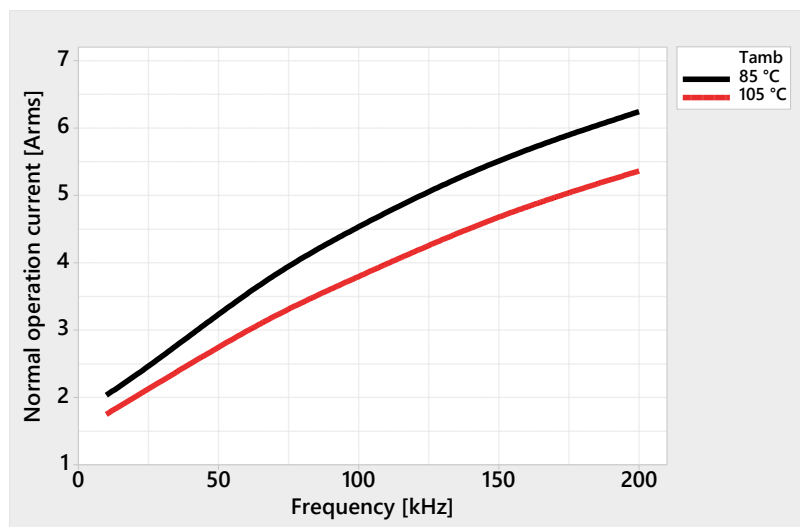

Typical permissible current as a function of ambient temperature

Standard termination type (B58043I5254M052)

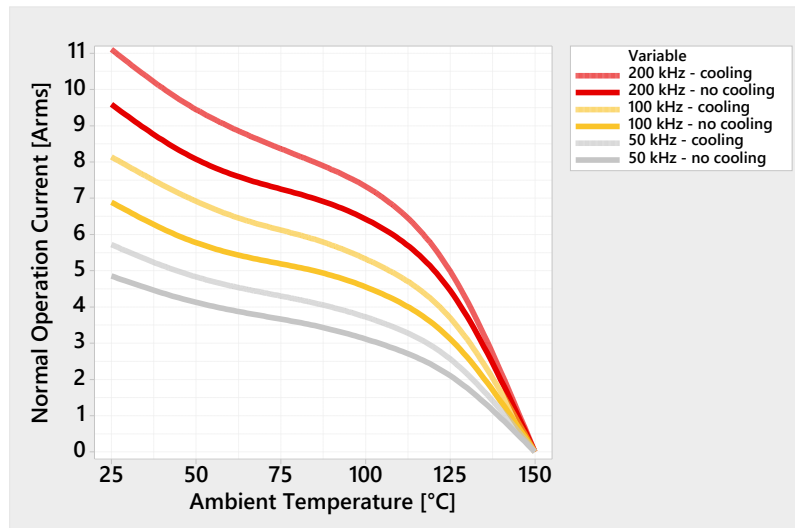

Measurement performed at V_{op} . The values correspond to a device temperature of 150 °C.

Without forced cooling:

Component mounted on PCB without any heatsink nor active airflow (convection only)



Without heatsink

With cooling:

Component mounted on PCB with additional heatsink (40 mm x 75 mm x 100 mm, aluminum, 1.2-1.4 K/W).

Heatsink is isolated from the PCB by a layer of Kapton® foil.

Moderate forced airflow is provided by the oven fan.

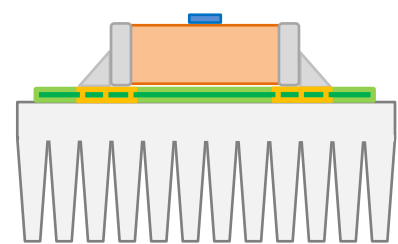

With heatsink

Soft termination type (B58043E5254M052)

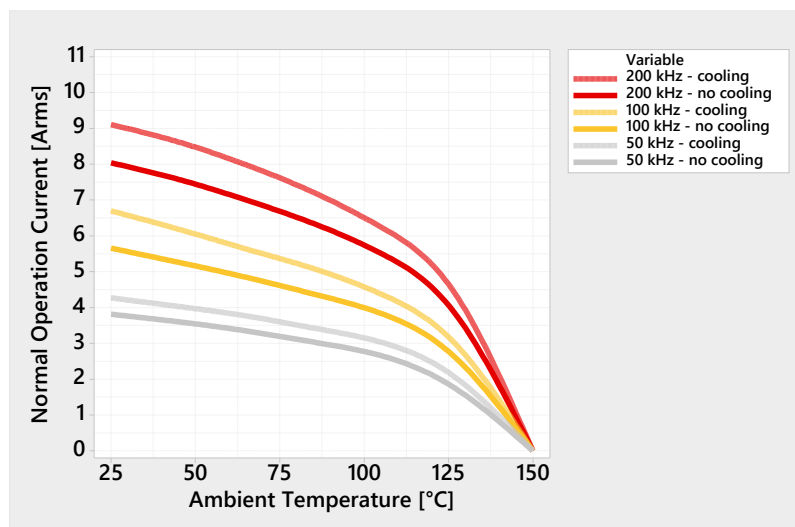

Reliability

A. Preconditioning:

- Reflow solder the capacitor on a PCB using the recommended soldering profile
- Check of external appearance
- Measurement of isolation resistance R_{ins} ³⁾
 - Apply $V_{pk,max}$ for 7 seconds and measure R_{ins} at room temperature:
Isolation resistance (@ $V_{pk,max}$, 7 s, 25 °C) **$R_{ins} > 100 M\Omega$**
- Measurement of electrical parameters C_0 and $\tan\delta$ according specification
 - Measure C_0 and $\tan\delta$ within 10 minutes to 1 hour afterwards:
Initial capacitance (@ 0 V_{DC} , 0.5 $V_{AC,RMS}$, 1 kHz, 25 °C) **C_0 acc. spec. on page 3**
Dissipation factor (@ 0 V_{DC} , 0.5 $V_{AC,RMS}$, 1 kHz, 25 °C) **$\tan\delta < 0.025$**

B. Performance of a specific reliability test.

C. After performing a specific test:

- Check the external appearance again
- Repeat the measurement of the electrical parameters
 - Apply $V_{pk,max}$ for 7 seconds and measure R_{ins} at room temperature:
Isolation resistance (@ $V_{pk,max}$, 7 s, 25 °C) **$R_{ins} > 100 M\Omega$**
 - Measure C_0 and $\tan\delta$:
Change of initial capacitance (@ 0 V_{DC} , 0.5 $V_{AC,RMS}$, 1 kHz, 25 °C) **$|\Delta C_0 / C_0| < 15\%$**
Dissipation factor (@ 0 V_{DC} , 0.5 $V_{AC,RMS}$, 1 kHz, 25 °C) **$\tan\delta < 0.05$**

³⁾ Note that the measurement of the isolation resistance R_{ins} using the described measurement conditions is for pre- and post-measurement within the scope of the AEC-Q200 reliability tests only.

Qualification tests based on AEC-Q200 Rev. D (Table 2)

Test	No.	Standard	Test conditions	Criteria
Pre- and Post-Stress Electrical Test	1	-	As described above	$ \Delta C_0 / C_0 $, $\tan\delta$ and R_{ins} within defined limits.
High Temperature Exposure	3	MIL-STD-202 Method 108	+150 °C, unpowered, 1000 hours	No mechanical damage. $ \Delta C_0 / C_0 $, $\tan\delta$ and R_{ins} within defined limits.
Temperature Cycling	4	JESD22 Method JA-104	-55 °C to +150 °C, ≤ 20 seconds transfer time, 15 minutes dwell time, 1000 cycles	No mechanical damage. $ \Delta C_0 / C_0 $, $\tan\delta$ and R_{ins} within defined limits.
Destructive Physical Analysis	5	EIA-469		No internal defects that might affect performance or reliability
Biased Humidity	7	MIL-STD-202 Method 103	+85 °C, 85% rel. hum., V_R , 1000 hours	No mechanical damage. $ \Delta C_0 / C_0 $, $\tan\delta$ and R_{ins} within defined limits.

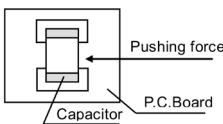
Test	No.	Standard	Test conditions	Criteria
High Temperature Operating Life	8	MIL-STD-202 Method 108	+150 °C, V _R , 1000 hours	No mechanical damage. ΔC ₀ /C ₀ , tanδ and R _{ins} within defined limits.
External Visual	9	MIL-STD-883 Method 2009	Visual inspection with magnifying glass	No external defects that might affect performance or reliability
Physical Dimension	10	JESD22 Method JB-100	Verify physical dimensions to the device specification using a caliper	Within specified tolerance
Resistance to Solvents	12	MIL-STD-202 Method 215	Dipping and cleaning with isopropanol	No mechanical damage. ΔC ₀ /C ₀ , tanδ and R _{ins} within defined limits.
Mechanical Shock	13	MIL-STD-202 Method 213	Acceleration 400 m/s ² Half sine pulse duration 6 milliseconds 4000 bumps	No mechanical damage. ΔC ₀ /C ₀ , tanδ and R _{ins} within defined limits.
Vibration	14	MIL-STD-202 Method 204	20 g / 20 min, 12 cycles, 3 axis 10 Hz to 2000 Hz	No mechanical damage. ΔC ₀ /C ₀ , tanδ and R _{ins} within defined limits.
Resistance to Soldering Heat	15	See <i>Soldering directions</i>		
ESD	17	AEC-Q200-002	HBM, ±25kV, 5 pulses each polarity	No mechanical damage. ΔC ₀ /C ₀ , tanδ and R _{ins} within defined limits.
Solderability	18	See <i>Soldering directions</i>		
Board Flex	21	AEC-Q200-005	Bending of 2 mm for 60 seconds (5 mm for soft termination types)	No mechanical damage. ΔC ₀ /C ₀ , tanδ and R _{ins} within defined limits.
Terminal Strength (SMD)	22	AEC-Q200-006	Apply a force of 17.7 N for 60 seconds 	No detaching of termination. No rupture of ceramic. ΔC ₀ /C ₀ , tanδ and R _{ins} within defined limits
Beam Load Test	23	AEC-Q200-003	Ceramics only	-

Taping and packing

Tape and reel packing in blister according to IEC 60286-3, tape width: 12 ±0.3 mm

Reel packing

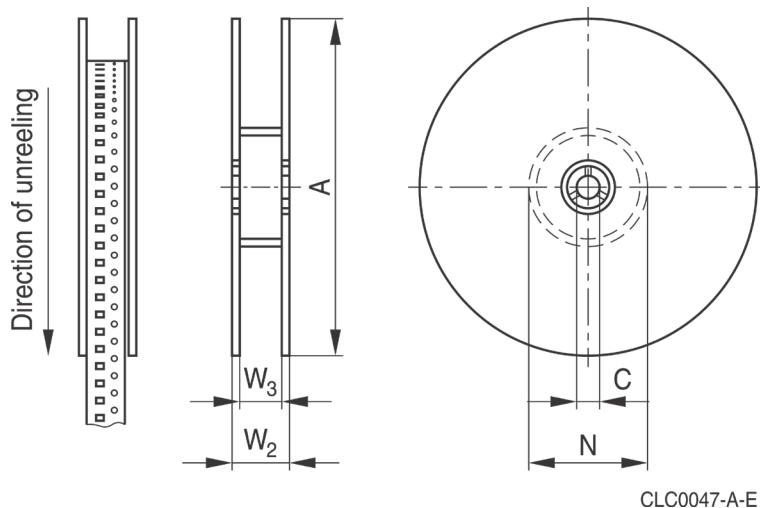

12-mm tape (Dimensions in mm)

A	180 max.
W ₂	18.4 max.
W ₃	13.65 ±1.75
C	12.8 min.
N	60 ±1

Part orientation

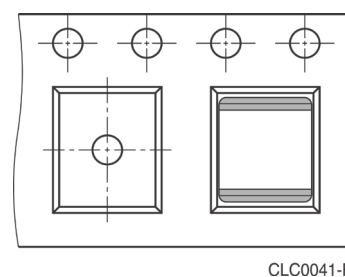

Leader, trailer

Trailer (tape end)

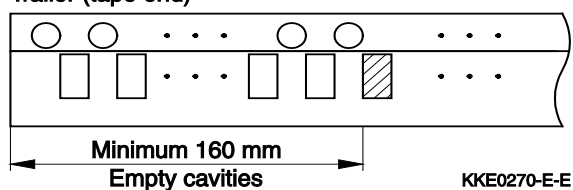

Leader

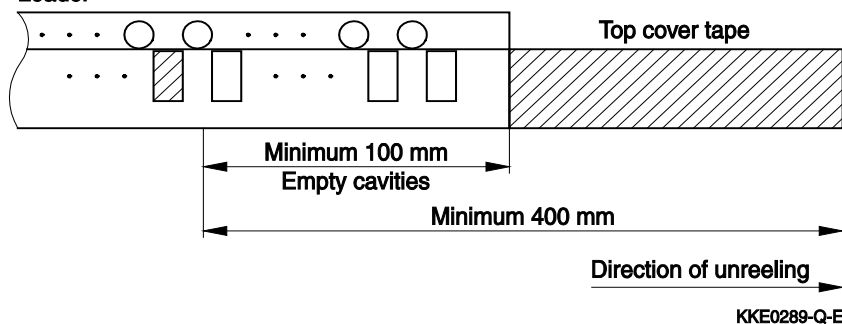

Packing unit: 1000 pcs. / reel

Internal Design and Termination

CeraLink 2220 is a PLZT (lead lanthanum zirconium titanate) based ceramic capacitor with anti-ferroelectric behavior, which is optimized for high frequency & high temperature power electronic applications, see our CeraLink *Technical Guide* for further details. The internal chip design offers high capacitance density, where the copper inner electrodes provide excellent thermal dissipation such that high current capabilities can be achieved in application.

In addition to the standard copper/nickel/tin terminal electrode, CeraLink 2220 components are available also with soft termination. Soft termination is a type of flexible termination in which a conductive resin layer is provided between the Cu base and Ni plating layer. The resin layer absorbs stress accompanying expansion or shrinkage of the solder joints due to thermal shock or flex stress on the board and prevents cracking of the capacitor element. Furthermore, it provides excellent performance in the AEC-Q200 board flex test as detailed below.

The nickel layer of the termination acts as a diffusion barrier and prevents leaching of the copper base metallization layer. This allows great flexibility in the selection of soldering parameters. The tin prevents the nickel layer from oxidizing and thus ensures better wetting by the solder. The nickel barrier termination is suitable for lead-free soldering, as well as for other commonly-used soldering methods, see *Soldering directions* for further details.

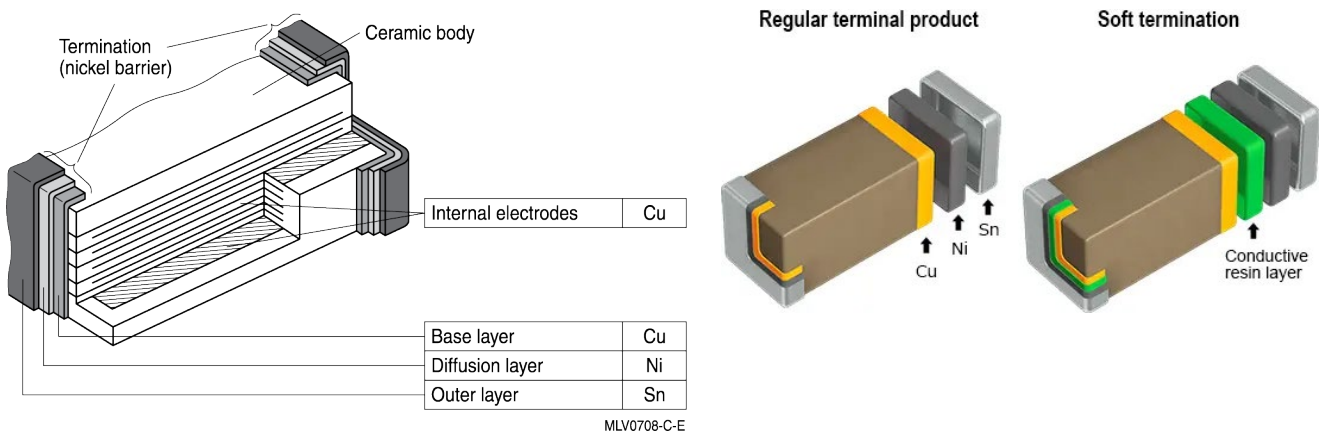

Typical bending test results for CeraLink 2220 for standard and soft termination

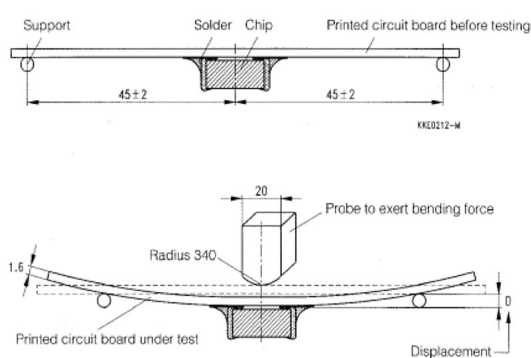

AEC-Q200 Rev. D - Method 005 - Board Flex Test

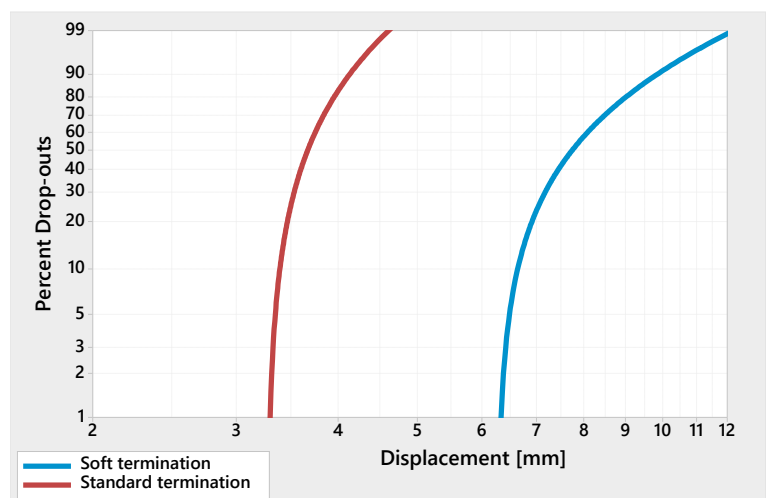

Soldering directions

1. Recommended reflow soldering profiles

Temperature ranges for reflow soldering according to IEC 60068-2-58 recommendations.

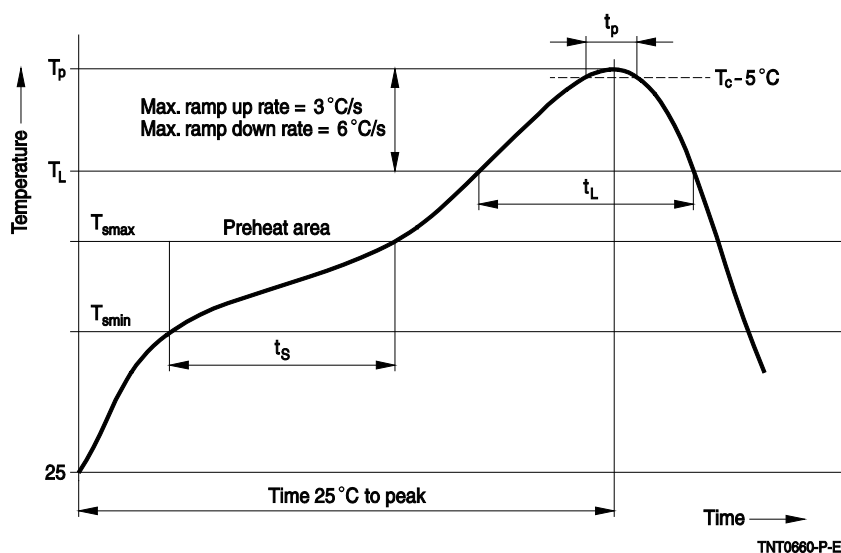

Profile feature		Sn-Pb eutectic assembly	Pb-free assembly
Preheat and soak			
- Temperature min	T_{smin}	100 °C	150 °C
- Temperature max	T_{smax}	150 °C	200 °C
- Time	t_{smin} to t_{smax}	60 ... 120 s	60 ... 120 s
Average ramp-up rate	T_{smax} to T_p	3 °C/s max.	3 °C/s max.
Liquidous temperature	T_L	183 °C	217 °C
Time at liquidous	t_L	40 ... 150 s	40 ... 150 s
Peak package body temperature	T_p ¹⁾	215 °C ... 260 °C ⁴⁾	235 °C ... 260 °C
Time (t_p) above ($T_p - 5$ °C)	t_p	10 ... 40 s	10 ... 40 s
Average ramp-down rate	T_p to T_{smax}	6 °C/s max.	6 °C/s max.
Time 25 °C to peak temperature		max. 8 minutes	max. 8 minutes

⁴⁾ Depending on package thickness

Notes: All temperatures refer to topside of the package, measured on the package body surface.

Number of reflow cycles: 3

2. Recommended solder

The use of no-clean solder products is recommended. In any case mild, non-activated fluxes should be used. Flux residues after soldering should be minimized.

3. Solder joint profiles

If the meniscus height is too low, that means the solder quantity is too low, the solder joint may break, i.e. the component becomes detached from the joint. This problem is sometimes interpreted as leaching of the external terminations. If the solder meniscus is too high, i.e. the solder quantity is too large, the converse effect may occur. As the solder cools down, the solder contracts in the direction of the component. If there is too much solder on the component, it has no leeway to evade the stress and may break. The figures below show good and poor solder joints for reflow soldering.

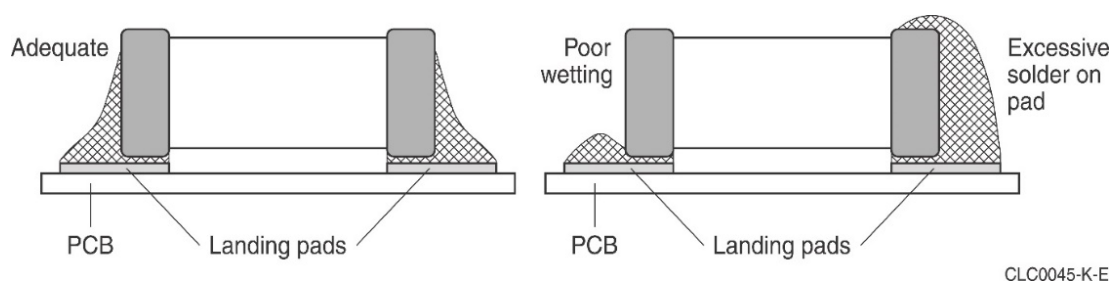

4. Notes for proper soldering

4.1. Preheating and cooling

According to IEC 60068-2-58. Please refer to section 0 of this chapter.

4.2. Repair/ rework

Manual soldering with a soldering iron must be avoided, hot-air methods are recommended for rework purposes.

4.3. Cleaning

All environmentally compatible agents are suitable for cleaning. Select the appropriate cleaning solution according to the type of flux used. The temperature difference between the components and cleaning liquid must not be greater than 100 °C. Ultrasonic cleaning should be carried out with the utmost caution. Too high ultrasonic power can impair the adhesive strength of the metallized surfaces.

4.4. Solder paste printing

An excessive application of solder paste results in a too high solder fillet, thus making the chip more susceptible to mechanical and thermal stress. Too little solder paste reduces the adhesive strength on the outer electrodes and thus weakens the bonding to the PCB. The solder should be applied smoothly to the end surface.

4.5. Selection of flux

Used flux should have less than or equal to 0.1 wt % of halogenated content, since flux residue after soldering could lead to corrosion of the termination and/or increased leakage current on the surface of the component. Strong acidic flux must not be used. The amount of flux applied should be carefully controlled, since an excess may generate flux gas, which in turn is detrimental to solderability.

4.6. Soldering cautions

CeraLink 2220 components are recommended for reflow soldering. Consult our local representative if other soldering methods are considered.

An excessively long soldering time or high soldering temperature results in leaching of the outer electrodes, causing poor adhesion and a change of electrical properties of the CeraLink due to the loss of contact between electrodes and termination. Keep the recommended down-cooling rate.

Iron soldering must be avoided, hot air methods are recommended for repair purposes.

After the soldering process, the capacitance of CeraLink can be lower. Applying rated voltage V_R to the device will re-establish the capacitance.

5. Solderability tests

Test	Standard	Test conditions SnPb soldering	Test conditions Pb-free soldering	Criteria
Wettability	IEC 60068-2-58	Immersion in 60/40 SnPb solder using non-activated flux at 215 ± 3 °C for 3 ± 0.3 s	Immersion in Sn96.5Ag3.0Cu0.5 solder using non- or low activated flux at 245 ± 3 °C for 3 ± 0.3 s	Covering of 95% of end termination, checked by visual inspection
Leaching resistance	IEC 60068-2-58	Immersion in 60/40 SnPb solder using mildly activated flux without preheating at 260 ± 5 °C for 10 ± 1 s	Immersion in Sn96.5Ag3.0Cu0.5 solder using non- or low activated flux without preheating at 260 ± 5 °C for 10 ± 1 s	No leaching of contacts
Resistance to soldering heat	MIL-STD-202 Method 210	Immersion in 60/40 SnPb solder at 260 °C for 10 s. Pre-heating at 150 °C for 60-120 sec.	Immersion in Sn96.5Ag3.0Cu0.5 solder at 260 °C for 10 s. Pre-heating at 150 °C for 60-120 sec.	No mechanical damage. $ \Delta C_0/C_0 $, $\tan\delta$ and R_{ins} within defined limits.
Solderability (Reflow Test)	-	3 times recommended reflow soldering profile	3 times recommended reflow soldering profile	No mechanical damage. Proper solder coating of contact areas. $ \Delta C_0/C_0 $, $\tan\delta$ and R_{ins} within defined limits.

Glossary

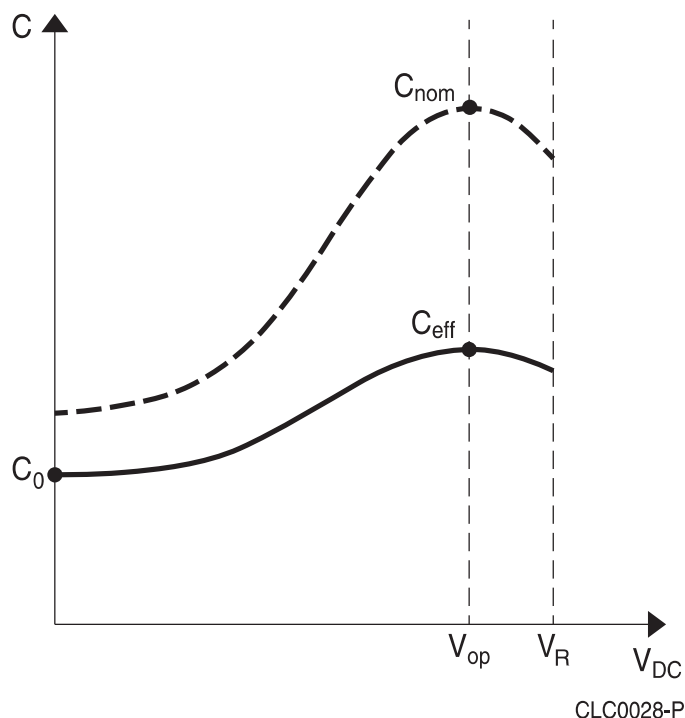

- Initial capacitance C_0 : Is the value at the origin of the hysteresis without any applied direct voltage.
- Effective capacitance C_{eff} : Occurs at V_{op} and is measured with an applied ripple voltage of 0.5 $V_{AC,RMS}$ and 1 kHz. The CeraLink is designed to have its highest capacitance value at the operating voltage V_{op} .
- Nominal capacitance C_{nom} : Is the value derived by the tangent of the mean hysteresis (as the derivative of the mean hysteresis is $dQ/dV \sim C$). See our *CeraLink Technical Guide* for further details.

Symbols and terms

AC	Alternating current
C_0	Initial capacitance @ 0 V _{DC} , 0.5 V _{AC,RMS} , 1 kHz, +25 °C
$C_{0, \text{unpoled}}^{\text{unpoled}}$ $C_{0, \text{typ}}$	Initial capacitance C_0 of unpoled component
$C_{\text{eff,typ}}$	Typical effective capacitance @ V_{op} , 0.5 V _{AC,RMS} , 1 kHz, +25 °C
$C_{\text{nom,typ}}$	Typical nominal capacitance @ V_{op} , quasistatic, +25 °C. See glossary for definition of the nominal capacitance
DC	Direct current
ESL	Equivalent serial inductance
ESR	Equivalent serial resistance
I_{op}	Operating ripple current, root mean square value of sinusoidal AC current
LP	Low profile
PCB	Printed circuit board
PLZT	Lead lanthanum zirconium titanate
R_{ins}	Insulation resistance @ $V_{\text{pk,max}}$, measurement time $t = 7 \text{ s}$, +25 °C. For pre- and post-measurements within the scope of the AEC-Q200 reliability tests.
$R_{\text{ins, typ}}$	Insulation resistance (inverse of insulation conductance) @ V_{op} , measurement time $t \geq 240 \text{ s}$, +25 °C
SAC	Tin silver copper alloy; lead-free solder paste
T_{amb}	Ambient temperature
$\tan \delta$	Dissipation factor @ 0 V _{DC} , 0.5 V _{AC,RMS} , 1 kHz, +25 °C
T_{device}	Device temperature. $T_{\text{device}} = T_{\text{amb}} + \Delta T$ (ΔT defines the self-heating of the device due to applied current).
V_{op}	Operating voltage at maximum attenuation capability
V_{R}	Rated voltage. Reference DC voltage for reliability tests.
$V_{\text{AC,RMS}}$	Root mean square value of sinusoidal AC voltage
$V_{\text{pk,max}}$	Maximum peak operating voltage
ΔT	Increase of temperature during operation

Cautions and warnings

General

- Do not use TDK Electronics CeraLink components for purposes not identified in our specifications, application notes and data books.
- Ensure the suitability of a CeraLink in particular by testing it for reliability during design-in. Always evaluate a CeraLink component under worst-case conditions.
- Pay special attention to the reliability of CeraLink devices intended for use in safety-critical applications (e.g. medical equipment, automotive, spacecraft, nuclear power plant). See *Important notes* section for further details.

Design notes

- Do not use CeraLink in applications, where a voltage of alternating polarity occurs, e.g. resonant circuits. Consult our local representative for further details.
- If used in snubber circuits, ensure that the sum of all voltages remains at the same polarity.
- Consider derating at higher operating temperatures. As a rule, lower temperatures and voltages increase the lifetime of CeraLink devices.
- If steep surge current edges are to be expected, make sure your design is as low-inductive as possible.
- Specified values only apply to CeraLink components that have not been subject to prior electrical, mechanical or thermal damage. The use of CeraLink devices in line-to-ground applications is therefore not advisable, and it is only allowed together with safety countermeasures such as thermal fuses.

Storage

- In order to maintain solderability the components must be stored in a non-corrosive atmosphere. Humidity, temperature and container materials are critical factors.
- Only store CeraLink capacitors in their original packaging. Do not open the package before storage or prior to processing. Touching the metallization of unsoldered components may change their soldering properties.
- Storage conditions in original packaging: temperature: -25 ... +45 °C, relative humidity: ≤ 75% annual average, ≤ 95% on max. 30 days in a year, dew precipitation and wetness are inadmissible.
- Do not store the components where they are exposed to heat or direct sunlight. Otherwise the packing material may be deformed or the components may stick together, causing problems during mounting. After opening the factory seals, such as polyvinyl-sealed packages, use the components as soon as possible.
- Avoid contamination of the CeraLink surface during storage, handling and processing.
- Avoid storing CeraLink devices in harmful environments where they are exposed to corrosive gases (e.g. SO_x, Cl).
- Use CeraLink as soon as possible after opening factory seals such as polyvinyl-sealed packages.
- Solder the components listed in this data sheet after shipment from TDK within 12 months.

Handling

- Do not drop CeraLink components or allow them to be chipped.
- Do not touch CeraLink with your bare hands - gloves are recommended.
- Avoid contamination of the CeraLink surface during handling.
- Washing processes to remove e.g. flux are recommended but should be used with caution since they may damage the product due to the possible static or cyclic mechanical loads (e.g. ultrasonic cleaning). Mechanical loads which may cause cracks to develop on the product and its parts must be avoided, since this might lead to reduced reliability or lifetime.
- The CeraLink 2220 was tested to withstand the board flex test defined in the AEC-Q200 rev. D, method 005. Nevertheless, avoid high mechanical stress like twisting or bending after soldering on a PCB.

Mounting

- When CeraLink devices are encapsulated with sealing material or overmolded with plastic material, electrical characteristics might be degraded and the life time reduced.
- Board fixation of CeraLink components using SMD adhesives should be avoided. In particular, adhesives with a high Shore hardness and mismatching coefficient of thermal expansion (CTE) might induce cracks in the ceramics. If fixation is not avoidable, adhesives with low Shore hardness and a CTE < 10 ppm/K should be used.
- Make sure the CeraLink component is not damaged before, during or after the mounting process (e.g. during pick and place)
- Make sure contacts and housings used for assembly with CeraLink components are clean before mounting.
- The surface temperature of an operating CeraLink can be higher than the ambient temperature. Ensure that adjacent components are placed at a sufficient distance from a CeraLink to allow proper cooling.
- Avoid contamination of the CeraLink surface during processing.

Soldering

- The use of mild, non-activated fluxes for soldering is recommended, as well as proper cleaning of the PCB.
- Complete removal of flux is recommended to avoid surface contamination that can result in an instable and/or high leakage current.
- Use resin-type or non-activated flux.
- Bear in mind that insufficient preheating may cause ceramic cracks.
- Rapid cooling by dipping in solvent is not recommended, otherwise a component may crack.
- Excessive usage of solder paste can reduce the mechanical robustness of the device, whereas insufficient solder may cause the CeraLink to detach from the PCB. Use an adequate amount of solder paste, but on the landing pads only.
- If an unsuitable cleaning fluid is used, flux residue or foreign particles may stick to the CeraLink surface and deteriorate its insulation resistance. Insufficient or improper cleaning of the CeraLink may cause damage to the component.
- See chapter Soldering directions for further details.

Operation

- Use CeraLink only within the specified operating temperature range.
- Use CeraLink only within specified voltage and current ranges.
- The CeraLink has to be operated in a dry atmosphere, which must not contain any additional chemical vapors or substances.
- Environmental conditions must not harm the CeraLink. Use the capacitor under normal atmospheric conditions only. A reduction of the oxygen partial pressure to below 1 mbar is not permissible.
- Prevent a CeraLink from contacting liquids and solvents.
- Avoid dewing and condensation.
- During operation, the CeraLink can produce audible noise due to its piezoelectric characteristic.
- CeraLink components are mainly designed for encased applications. Under all circumstances avoid exposure to:
 - direct sunlight
 - rain or condensation
 - steam, saline spray
 - corrosive gases
 - atmosphere with reduced oxygen content

This listing does not claim to be complete, but merely reflects the experience of the manufacturer.

Display of ordering codes for TDK Electronics products

The ordering code for one and the same product can be represented differently in data sheets, data books, other publications, on the company website, or in order-related documents such as shipping notes, order confirmations and product labels. **The varying representations of the ordering codes are due to different processes employed and do not affect the specifications of the respective products.** Detailed information can be found on the Internet under www.tdk-electronics.tdk.com/orderingcodes.

Important notes

The following applies to all products named in this publication:

1. Some parts of this publication contain **statements about the suitability of our products for certain areas of application**. These statements are based on our knowledge of typical requirements that are often placed on our products in the areas of application concerned. We nevertheless expressly point out **that such statements cannot be regarded as binding statements about the suitability of our products for a particular customer application**. As a rule, we are either unfamiliar with individual customer applications or less familiar with them than the customers themselves. For these reasons, it is always ultimately incumbent on the customer to check and decide whether a product with the properties described in the product specification is suitable for use in a particular customer application.
2. We also point out that **in individual cases, a malfunction of electronic components or failure before the end of their usual service life cannot be completely ruled out in the current state of the art, even if they are operated as specified**. In customer applications requiring a very high level of operational safety and especially in customer applications in which the malfunction or failure of an electronic component could endanger human life or health (e.g. in accident prevention or life-saving systems), it must therefore be ensured by means of suitable design of the customer application or other action taken by the customer (e.g. installation of protective circuitry or redundancy) that no injury or damage is sustained by third parties in the event of malfunction or failure of an electronic component.
3. **The warnings, cautions and product-specific notes must be observed.**
4. In order to satisfy certain technical requirements, **some of the products described in this publication may contain substances subject to restrictions in certain jurisdictions (e.g. because they are classed as hazardous)**. Useful information on this will be found in our Material Data Sheets on the Internet (www.tdk-electronics.tdk.com/material). Should you have any more detailed questions, please contact our sales offices.
5. We constantly strive to improve our products. Consequently, **the products described in this publication may change from time to time**. The same is true of the corresponding product specifications. Please check therefore to what extent product descriptions and specifications contained in this publication are still applicable before or when you place an order.

We also **reserve the right to discontinue production and delivery of products**. Consequently, we cannot guarantee that all products named in this publication will always be available. The aforementioned does not apply in the case of individual agreements deviating from the foregoing for customer-specific products.

6. Unless otherwise agreed in individual contracts, **all orders are subject to our General Terms and Conditions of Supply**.
7. **Our manufacturing sites serving the automotive business apply the IATF 16949 standard**. The IATF certifications confirm our compliance with requirements regarding the quality management system in the automotive industry. Referring to customer requirements and customer specific requirements ("CSR") TDK always has and will continue to have the policy of respecting individual agreements. Even if IATF 16949 may appear to support the acceptance of unilateral requirements, we hereby like to emphasize that **only requirements mutually agreed upon can and will be implemented in our Quality Management System**. For clarification purposes we like to point out that obligations from IATF 16949 shall only become legally binding if individually agreed upon.

Important notes

8. The trade names EPCOS, CarXield, CeraCharge, CeraDiode, CeraLink, CeraPad, CeraPlas, CSMP, CTVS, DeltaCap, DigiSiMic, ExoCore, FilterCap, FormFit, LeaXield, MiniBlue, MiniCell, MKD, MKK, ModCap, MotorCap, PCC, PhaseCap, PhaseCube, PhaseMod, PhiCap, PowerHap, PQSine, PQvar, SIFERRIT, SIFI, SIKOREL, SilverCap, SIMDAD, SiMic, SIMID, SineFormer, SIOV, ThermoFuse, WindCap, XieldCap are **trademarks registered or pending** in Europe and in other countries. Further information will be found on the Internet at www.tdk-electronics.tdk.com/trademarks.

Release 2020-06