









Inductors

SMT inductors, SIMID series
Selection guide, General

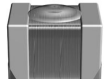
Date: October 2008

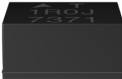
SMT inductors, SIMID series
Selection guide

	EIA size	Type	L_R μH	I_R mA	Features
Laser-cut					
	0402	SIMID 0402-A B82499A	0.001 ... 0.10	90 ... 400	Standard
	0603	SIMID 0603-C B82496C	0.001 ... 0.22	110 ... 1800	Standard
Wire-wound					
	0805	SIMID 0805-F B82498F	0.0027 ... 6.8	80 ... 1000	RF applications, flat top
		SIMID 0805-B B82498B	0.0027 ... 4.7	90 ... 1000	RF applications
	1008	SIMID 1008-A B82494A	0.010 ... 100	60 ... 280	Standard
	1210	SIMID 1210-T B82422T	0.010 ... 100	60 ... 450	Standard
		SIMID 1210-100 B82422A*100	0.0082 ... 100	65 ... 800	High temperature
		SIMID 1210-H B82422H	0.1 ... 680	61 ... 2050	High current, high temperature
		SIMID 1210-A B82422A	0.0082 ... 100	65 ... 700	RF applications
		SIMID 1210-01 B82412A	0.010 ... 10	90 ... 700	Low profile
	1812	SIMID 1812-T B82432T	1 ... 1000	70 ... 1300	High current
		SIMID 1812-C B82432C	1 ... 1000	55 ... 600	RF applications
		SIMID 1812-A B82432A	1 ... 1000	55 ... 600	RF applications
	2220	SIMID 2220-A B82442A	1 ... 10 000	25 ... 1800	Standard
		SIMID 2220-H B82442H	1 ... 10 000	35 ... 2500	High current
		SIMID 2220-T B82442T	1 ... 10 000	46 ... 3510	Very high current

SMT inductors, SIMID series

General

1 General

These SMT inductors are available in 16 series and seven standard sizes.

They are suitable for many different applications, for instance low- and high-frequency decoupling of signal and control circuits, filtering of power supply lines and in other filters. They are also to be found in resonant circuits, impedance matching and energy storage applications. Furthermore, they are needed wherever it is necessary to ensure electromagnetic compatibility.

SMT inductors of the SIMID series are produced either by cutting a spiral into a copper foil by a laser beam (laser-cut technology) or by winding a copper wire onto the core (wire-wound technology).

2 Laser-cut inductors

The smallest sizes 0402 and 0603 are manufactured using laser-cut technology.

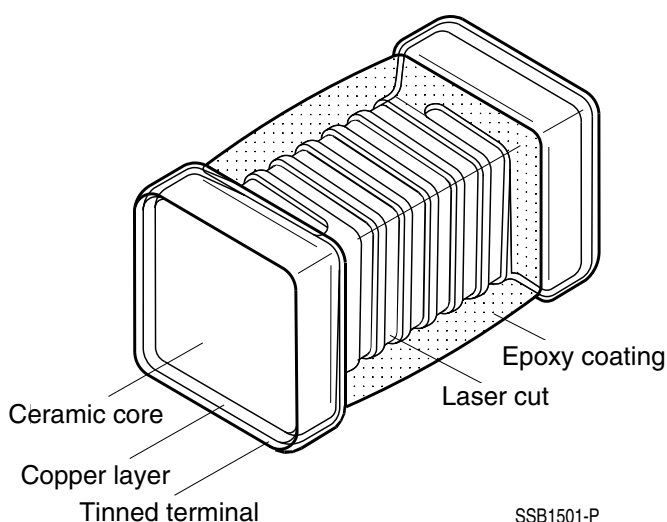
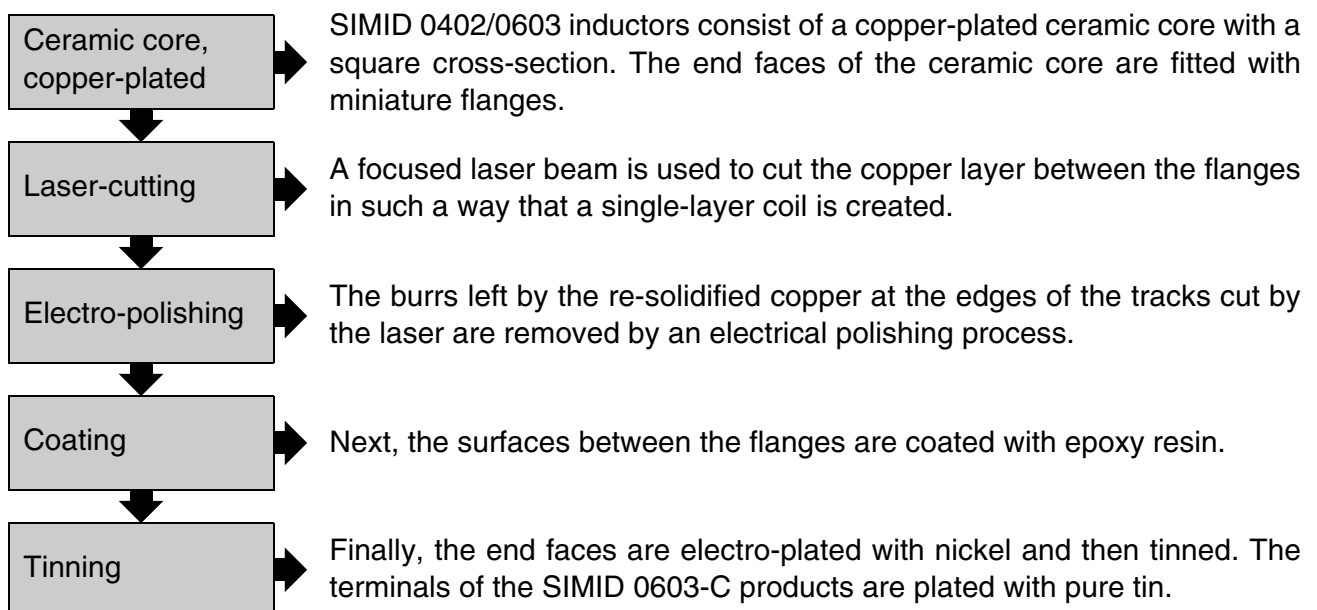

Figure 1
Construction of a laser-cut inductor

SMT inductors, SIMID series

General

Laser-cut SMT inductors exhibit very good RF characteristics, high resonant frequencies, close inductance tolerances and extremely high reliability. In contrast to some multilayer coils commonly used, they do not develop polarization effects, i.e. their L value is not affected by their mounting orientation.

The components of the SIMID 0603-C series are plated with pure tin and rated for –55 to +150 °C temperature range to meet the requirements of the automobile industry.

3 Wire-wound inductors

SIMID inductors of size 0805 and higher are manufactured with enamelled copper wire windings and soldered or welded terminals.

In SIMID 1008 inductors the ends of the coils are soldered to the terminals. In all others the windings are welded to the terminals. To meet environmental requirements, no lead is used in these product series.

Three different welding methods are used:

- Thermocompression welding in the manufacture of SIMID 0805-B and 0805-F:
The enamelled Cu wire is bonded to the core metallization by a heated welding electrode.
- Ultrasonic welding in the manufacture of SIMID 1210-A/1210-01/1812-A:
The winding wire is cold welded to the silver plated bronze terminals of the component by an ultrasonic sonotrode.
- Laser welding in the manufacture of SIMID 1210-T/1210-100/1210-H/1812-T/1812-C/2220-A/2220-H/2220-T:
The enamelled Cu wire is welded to the tin plated bronze terminal in sandwich mode by a laser pulse.

Advantages of welded connections

Welded connections withstand considerably higher temperatures than soldered connections. For example, the upper category temperature of the SIMID series components with welded wrapped terminals is specified as 125 °C and in some cases as high as 150 °C.

The series 1210-H, 1812-T, 2220-A, -H and -T are already AEC-Q200 qualified, which foresees hot storage at 150 °C.

4 High-current designs

Figure 2 shows a comparison of the current handling capabilities of the standard and high-current designs as a function of inductance.

With the new SIMID 1210-H high-current version EPCOS has achieved a major advance in the miniaturization of SMT inductors. Compared to the standard SIMID 1812-C this presents higher current handling for the same L figures in 60% less volume.

SMT inductors, SIMID series

General

Overall higher currents are achieved with the new SIMID 2220-T, which exhibits almost twice the current handling of the standard SIMID 2220-A thanks to optimized core design.

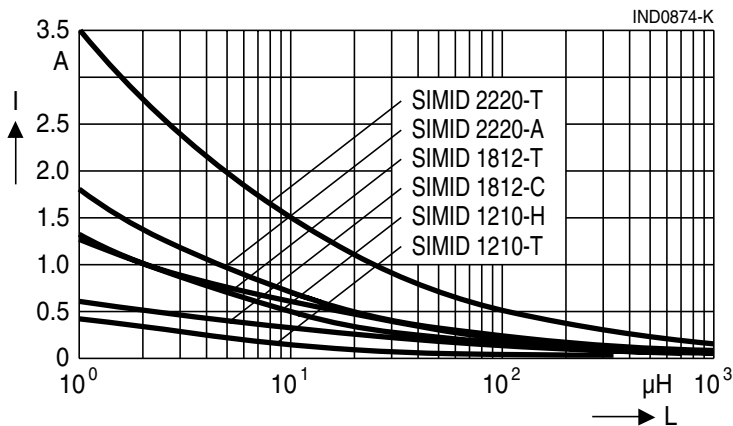

Figure 2

Rated current I versus L value at an ambient temperature $T_A = 85\text{ °C}$. Comparison between SIMID 1210-T/1210-H/1812-C/1812-T/2220-A and 2220-T

5 Typical applications

Typical applications for SMT inductors with laser-cut windings

- Resonant circuits and impedance matching
- Mobile telephones, digital cameras, GPS devices, keyless entry systems for cars, TPMS (Tire Pressure Monitoring System)

Most common fields of application of wire-wound SMT inductors:

- Consumer
- Handheld devices
- Automotive electronics
- Industrial electronics
- Antenna systems
- DC/DC converters
- Telecommunications

6 Sizes

Sizes are coded by a four-digit system. The code differs depending on the standard which it is based on.

The American EIA standards require length and width to be stated in hundredths of an inch. In European standards and in IEC draft standards these dimensions are coded in tenths of a millimeter. The following table summarizes the sizes:

SMT inductors, SIMID series

General

Length × width (mm)	EIA	IEC/EN
1.0 × 0.5	0402	1005
1.6 × 0.8	0603	1608
2.0 × 1.2	0805	2012
2.5 × 2.0	1008	2520
3.2 × 2.5	1210	3225
4.5 × 3.2	1812	4532
5.6 × 5.0	2220	5650

7 Marking of SMT inductors, SIMID series

The data specified on components and reel are given in the data sheets. Inductance, inductance tolerance and date of manufacture are encoded on the component as follows:

7.1 Sizes 0402 to 0805

No marking on SIMID 0402 to SIMID 0805.

7.2 Size 1008

On SIMID 1008 components the inductance value, in μH , is encoded as in the following example
e. g.: 101 = $10 \times 10^1 \mu\text{H} = 100 \mu\text{H}$

7.3 Sizes 1210 to 2220

SIMID 1210-01 without marking.

On all other component of SIMID 1210 to SIMID 2220 the inductance, tolerance and date of manufacture are encoded.

Inductance:

- SIMID 1210-T/H, SIMID 1812-T, SIMID 2220-T (encoding in μH):
example: 101 = $10 \times 10^1 \mu\text{H} = 100 \mu\text{H}$
- All other series (encoding in nH): example: 683 = $68 \times 10^3 \text{nH} = 68\,000 \text{nH} = 68 \mu\text{H}$

Tolerance (encoding to IEC 60062):

$\pm 2\% \triangleq \text{G}$; $\pm 3\% \triangleq \text{A}$; $\pm 5\% \triangleq \text{J}$; $\pm 10\% \triangleq \text{K}$; $\pm 20\% \triangleq \text{M}$
 $\pm 0.2 \text{nH} \triangleq \text{Z}$, $\pm 0.3 \text{nH} \triangleq \text{A}$ (SIMID 0402/0603)

Date of manufacture:

The date of manufacture is encoded using four digits, e. g. 8423:

- 8 = Calendar year 2008
- 42 = Calendar week 42
- 3 = 3rd day of the week (Wednesday).