

# Aluminum Electrolytic Capacitors

## General technical information

Date: June 2026

## General technical information

### 1 Basic construction of aluminum electrolytic capacitors

Aluminum electrolytic capacitors assume a special position among the various types of capacitors since their principle of operation relies, in part, on electrochemical processes.

The advantages of aluminum electrolytic capacitors that have led to their wide application range are their high volumetric efficiency (i.e. capacitance per unit volume), which enables the production of capacitors with up to one Farad capacitance, and the fact that an aluminum electrolytic capacitor provides a high ripple current capability together with a high reliability and an excellent price/performance ratio.

As is the case with all capacitors, an aluminum electrolytic capacitor comprises two electrically conductive material layers that are separated by a dielectric layer. One electrode (the anode) is formed by an aluminum foil with an enlarged surface area. The oxide layer ( $\text{Al}_2\text{O}_3$ ) that is built up on this is used as the dielectric. In contrast to other capacitors, the counter electrode (the cathode) of aluminum electrolytic capacitors is a conductive liquid, the operating electrolyte. A second aluminum foil, the so-called cathode foil, serves as a large-surfaced contact area for passing current to the operating electrolyte.

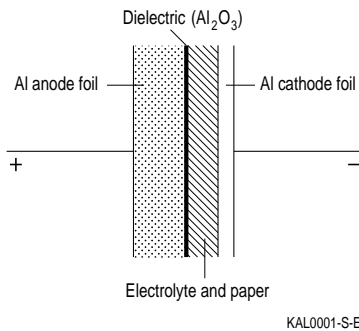

Figure 1  
Basic construction of an aluminum electrolytic capacitor

$$C = \epsilon_0 \cdot \epsilon_r \cdot \frac{A}{d}$$

C	Capacitance	F
$\epsilon_0$	Absolute permittivity	As/Vm
$\epsilon_r$	relative permittivity	(9.5 for $\text{Al}_2\text{O}_3$ )
A	Capacitor electrode surface area	$\text{m}^2$
d	Electrode spacing	m

The anode of an aluminum electrolytic capacitor is an aluminum foil of extreme purity. The effective surface area of this foil is greatly enlarged (by a factor of up to 200) by electrochemical etching in order to achieve the maximum possible capacitance values. The type of etch pattern and the degree of etching is matched to the respective requirements by applying specific etching processes.

## General technical information

Etched foils enable very compact aluminum electrolytic capacitor dimensions to be achieved and are used almost exclusively nowadays. The electrical characteristics of aluminum electrolytic capacitors with plain (not etched) foils are, in part, better, but these capacitors are considerably larger and are only used for special applications nowadays.

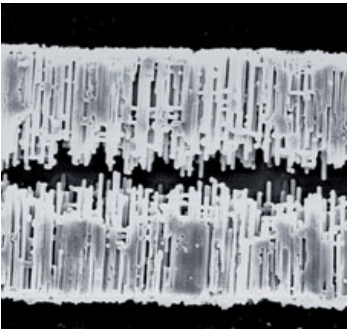

Figure 2  
Structure of anode foil for high-voltage capacitors (magnification 300x)

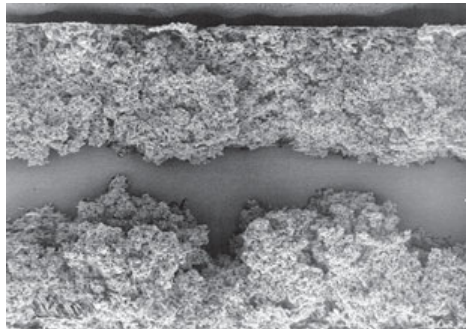
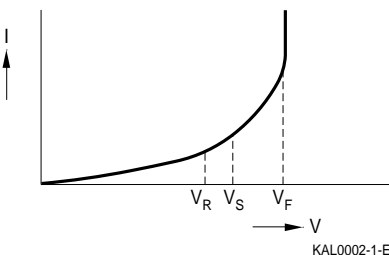

Figure 3  
Structure of anode foil for low-voltage capacitors (magnification 400x)

The dielectric layer of an aluminum electrolytic capacitor is created by anodic oxidation (forming) to build up an aluminum oxide layer on the foil. The layer thickness increases in proportion to the forming voltage at a rate of approximately 1.2 nm/V. Even for capacitors for very high voltages, layer thicknesses of less than 1  $\mu\text{m}$  are attained, thus enabling very small electrode spacings. This is another reason for the high volumetric efficiency achieved (e.g. in comparison to the minimum thickness of a paper dielectric, 6 to 8  $\mu\text{m}$ ).

During the forming process the very fine pits of the etched foils will encrust partially in proportion to the forming voltage. Due to this effect, the final operating voltage range must already be taken into account when the foils are etched.

The oxide layer constitutes a non-linear voltage-dependent resistance that causes the DC current to increase more steeply as the voltage increases. A characteristic curve as shown in figure 4 is obtained.



- $V_R$  = Rated voltage
- $V_S$  = Surge voltage
- $V_F$  = Forming voltage
- $I$  = DC current

Figure 4  
Current-voltage characteristic of an aluminum electrolytic capacitor

## General technical information

When the forming voltage  $V_F$  is exceeded, the forming process restarts and large amounts of gas and heat are generated. The same effect, yet on a smaller scale, can already be observed in the knee of the curve. In order to achieve a high degree of operating safety of the capacitor, the rated voltage  $V_R$  is defined as being on the quasi-linear part of the curve. As the capacitor is subjected to surge voltages  $V_S$  for short periods only, this range lies between the rated voltage and the forming voltage. The difference between forming voltage and operating voltage, the so-called overanodization, thus has a substantial effect on the operating reliability of the capacitor. High overanodization offers the possibility of producing especially reliable capacitors designated as long-life grade "LL" capacitors to IEC 60384-1.

Since the electrolytic capacitors have a liquid as a cathode, they are also designated as "wet" or "non-solid" capacitors. The liquid has the advantage that it fills the fine etching pits, therefore optimally fitting into the anode structure.

The two aluminum foils are separated by paper spacers. The paper serves various purposes, it serves as a container for the electrolyte – the electrolyte is stored in the pores of the absorbent paper – and also as a spacer to prevent electric short-circuits, as well as ensuring the required dielectric strength between the anode and cathode foils.

Riveting and / or welding processes are used to connect the tabs to the capacitor's cover disc with external capacitor terminals.

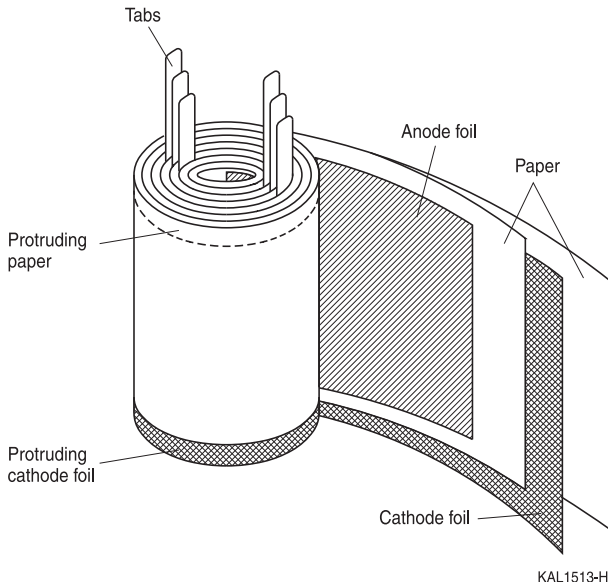

Figure 5  
Winding construction of an aluminum electrolytic capacitor

## General technical information

An aluminum electrolytic capacitor constructed in the way described above will only operate correctly if the positive potential is connected to the formed Al foil (anode), and the negative potential to the cathode foil. If the opposite polarity were to be applied, this would cause an electrolytic process resulting in the formation of a dielectric layer on the cathode foil. In this case strong internal heat generation and gas emission may occur and destroy the capacitor. Secondly, the cathode capacitance, which will progressively decrease as the oxide layer thickness increases, and which is connected in series with the anode capacitance, would reduce the overall capacitance considerably.

In most applications, aluminum electrolytic capacitors – as poled devices – are used with a DC voltage bias of proper polarity with some superimposed AC voltage. Reverse polarities of up to 1.5 V are permissible for short periods of time as the formation of a damaging oxide layer on the cathode only starts at voltages of this magnitude. This is because the cathode foil is covered by an air-oxide layer that corresponds to an anodized dielectric layer with a breakdown voltage of approximately 1.5 V.

## General technical information

### 2 Standards and specifications

Generally, the mentioned standards in this publication refer to the edition applied at the time when the product was evaluated and respectively released.

TDK reserves the right at its discretion to implement updates of international standard edition e.g., in the requalification, without further notice.

#### 2.1 General-purpose grade and long-life grade capacitors

Aluminum electrolytic capacitors are generally divided into two basic reliability categories: capacitors for high-reliability applications and capacitors for general-purpose applications. This differentiation has also been adopted in the relevant IEC standards.

In IEC publications aluminum electrolytic capacitors for high-reliability applications are identified as "Long-Life Grade" capacitors. The abbreviation LL is stamped on the capacitors. In addition to the over-anodization as described in chapter 1, further measures are taken to enhance the reliability. Generally, the materials used for aluminum electrolytic capacitors must meet strict purity requirements, and those used for producing LL grade capacitors must be specially selected. The design effort required for such capacitors affects both the case size and the price.

Aluminum electrolytic capacitors for general applications are called "General-Purpose Grade" (GP) in IEC publications.

#### 2.2 Applicable standards

The international standard for aluminum electrolytic capacitors is IEC 60384-4.

The sectional specification mentioned above is complemented by a set of detail specifications that applies to specific design types (e.g. electrolytic capacitors with axial wire leads). Frequently these detail specifications state better electrical ratings than the sectional specifications. The detail specifications also include maximum permissible dimensions in relation to capacitance and rated voltage.

The capacitance ratings given in recent specifications are generally in accordance with the E3 or E6 series. The rated voltage values are standardized according to the R5 series, in exceptional cases the voltage ratings have been chosen to meet specific requirements.

The following standards are applicable to aluminum electrolytic capacitors with a non-solid electrolyte:

IEC 60384-1	(identical with DIN EN 60384-1, EN 60384-1): Generic specification: Fixed capacitors for use in electronic equipment
IEC 60384-4	(identical with EN 60384-4): Sectional specification: Aluminum electrolytic capacitors with solid and non-solid electrolyte
IEC 60384-4-1	(identical with EN 60384-4-1): Blank detail specification: Fixed aluminum electrolytic capacitors with non-solid electrolyte

Important notes on proper use of aluminum electrolytic capacitors can also be found in CLC/TR 50454 "Guide for the application of aluminium electrolytic capacitors".

## General technical information

### 2.3 AEC-Q200 standard

Our components that are qualified based on the AEC-Q200 standard are tested according to the detailed test conditions described in the test report that is available to customers upon request.

## 3 Definitions of electrical parameters

### 3.1 Voltages

#### 3.1.1 Rated voltage $V_R$

The rated voltage  $V_R$  is the direct voltage value for which the capacitor has been designed and which is indicated upon it. For aluminum electrolytic capacitors, rated voltages of  $\leq 100$  V are usually designated as “low voltage” and rated voltages  $> 100$  V as “high voltage”. For details, refer to chapter “General technical information, 15 Structure of the ordering code (part number)”, page 39.

#### 3.1.2 Operating voltage $V_{op}$

The capacitors listed in the databook can be operated continuously at the full rated voltage (including superimposed AC voltage) within the entire operating temperature range.

The permissible voltage range for continuous operation lies between the rated voltage and 0 V. The capacitors are also able to handle voltages down to  $-1.5$  V for short periods of time. For details, refer to chapter “General technical information, 3.1.6 Reverse voltage” on page 8. Different rules may apply for customized capacitors.

#### 3.1.3 Surge voltage $V_S$

The surge voltage is the maximum voltage which may be applied to the capacitor for short periods of time, i.e. up to 5 times for 1 minute each per hour. Surge voltage testing is conducted according to IEC 60384-4. For the surge voltage limits refer to “Specifications and characteristics in brief” listed for each series.

#### 3.1.4 Transient voltage

Some capacitor types can withstand voltage pulses exceeding the surge voltage  $V_S$ . As the requirements differ largely depending on the individual applications, we do not state general ratings but match the overvoltage capability to customer requirements.

#### 3.1.5 Superimposed AC, ripple voltage

A superimposed alternating voltage, or ripple voltage, may be applied to aluminum electrolytic capacitors, provided that

- the sum of the direct voltage and superimposed alternating voltage does not exceed the rated voltage, and
- the maximum allowed ripple current is not exceeded (refer to chapter “General technical information, 4 Ripple current considerations” on page 19) and that no polarity reversal will occur.

## General technical information

### 3.1.6 Reverse voltage

Aluminum electrolytic capacitors are polar capacitors. Where necessary, voltages of opposite polarity should be prevented by connecting a diode. The diode's conducting-state voltage of approximately 0.8 V is permissible. Reverse voltages  $\leq 1.5$  V are tolerable for a duration of less than 1 second, but not in continuous or repetitive operation.

## 3.2 Capacitance

### 3.2.1 AC and DC capacitance

The capacitance of a capacitor can be determined by measuring its AC impedance (taking into account amplitude and phase) or by measuring the charge it will hold when a direct voltage is applied. The two methods produce slightly different results. As a general rule, it can be said that DC voltage based measurements (DC capacitance) yield higher values (DC capacitance) than the alternating current method (AC capacitance). The factors are approximately 1.1 to 1.5 and maximum deviations occur with capacitors of low voltage ratings.

Corresponding to the most common applications (e.g. smoothing and coupling), it is most usual to determine the AC capacitance of aluminum electrolytic capacitors.

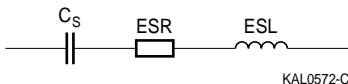

Figure 6  
Simplified equivalent circuit diagram of an electrolytic capacitor

For this purpose, the capacitive component of the equivalent series circuit (the series capacitance  $C_S$ ) is determined by applying an alternating voltage of  $\leq 0.5$  V. As the AC capacitance depends on frequency and temperature, IEC 60384-1 and IEC 60384-4 prescribe a measuring frequency of 100 Hz or 120 Hz and a temperature of 20 °C (other reference values by special request).

There are few applications (e.g. uninterruptible power supplies) in which the DC capacitance is relevant. In spite of this fact, capacitors for which the capacitance has been determined by the AC method are also used in such applications, whereby allowances are made to compensate for the difference between the two measuring methods.

However, in exceptional cases it may be necessary to determine the DC capacitance. The IEC publications do not provide any corresponding specifications. Because of this, a separate DIN standard has been defined. This standard, DIN 41328-4, describes a measuring method involving one-time, non-recurrent charging and discharging of the capacitor.

### 3.2.2 Rated capacitance $C_R$

The rated capacitance is the AC capacitance value for which the capacitor has been designed and which is indicated upon it.  $C_R$  is determined by specific measurement methods described in the relevant standards (IEC 60384-1 and IEC 60384-4). Preferred capacitance values are generally taken from the E3 or E6 series.

We specify  $C_R$  in  $\mu\text{F}$  as the AC capacitance measured at 100 Hz or 120 Hz and 20 °C, to IEC 60384-4.

## General technical information

### 3.2.3 Capacitance tolerance

The capacitance tolerance is the range within which the actual capacitance may deviate from the specific rated capacitance. Where the capacitance tolerances are to be indicated on the components themselves, we use code letters to IEC 60062; this code letter is also part of the ordering code. For details refer to chapter “General technical information, 13 Marking of the capacitors” on page 37.

### 3.2.4 Temperature dependence of the capacitance

The capacitance of an electrolytic capacitor is not a constant quantity that retains its value under all operating conditions. The temperature has a considerable effect on the capacitance. With decreasing temperature, the viscosity of the electrolyte increases, thus reducing its conductivity. The resulting typical behavior is shown in figure 7.

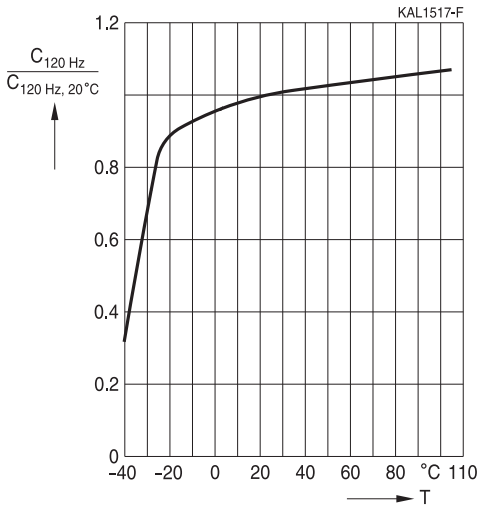

Figure 7  
Example of temperature dependence of capacitance C

As a general rule, the characteristic curves are steeper for lower rated voltages and increasing anode surface roughness (deeper etching).

## General technical information

### 3.2.5 Frequency dependence of the capacitance

The AC capacitance depends not only on the temperature but also on the measuring frequency. Figure 8 shows the typical behavior. Typical values of the effective capacitance can be derived from the impedance curve, as long as the impedance is still in the range where the capacitive component is dominant.

$$C = \frac{1}{2 \cdot \pi \cdot f \cdot Z}$$

C Capacitance F

f Frequency Hz

Z Impedance  $\Omega$

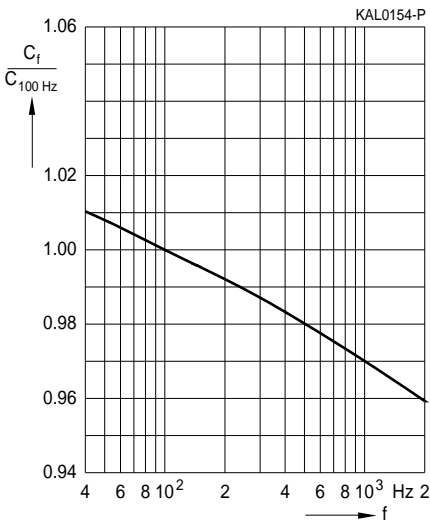

Figure 8  
Capacitance C versus frequency f  
Typical behavior

### 3.2.6 Charge-discharge proof

Frequent charging/discharging cycles may lead to a decrease in capacitance.

Only when specifically specified in the product/series data sheet, such capacitor can be considered as charge-discharge proof. This means that  $10^6$  switching cycles may cause a capacitance reduction up to 10% of the initial value (Charge-discharge test to IEC 60384-4).

Customized solutions are also available upon request.

## General technical information

### 3.3 Dissipation factor $\tan \delta$

The dissipation factor  $\tan \delta$  is the ratio of the equivalent series resistance to the capacitive reactance component in the equivalent series circuit, or the ratio of effective power (dissipated power) to reactive power for sinusoidal voltages.

It is measured using the same set-up as for the series capacitance  $C_S$  (see figure 6). IEC 60384-4 specifies the following maximum values:

Rated voltage	$4 \text{ V} < V_R \leq 10 \text{ V}$	$10 \text{ V} < V_R \leq 25 \text{ V}$	$25 \text{ V} < V_R \leq 63 \text{ V}$	$63 \text{ V} < V_R$
Maximum value for the 100 Hz dissipation factor (to IEC 60384-4)	0.5	0.35	0.25	0.20

These values apply to capacitors with a maximum charge of 100000  $\mu\text{C}$ . Proportionally higher dissipation factors are permissible for capacitors with higher charge values. Different values and frequencies than those stated in the table above are possible for individual series. In this case they can be found in the table, "Specifications and characteristics in brief", for the corresponding series.

The dissipation factor, like the capacitance, varies with frequency and temperature. An example of such characteristics is shown in figure 9.

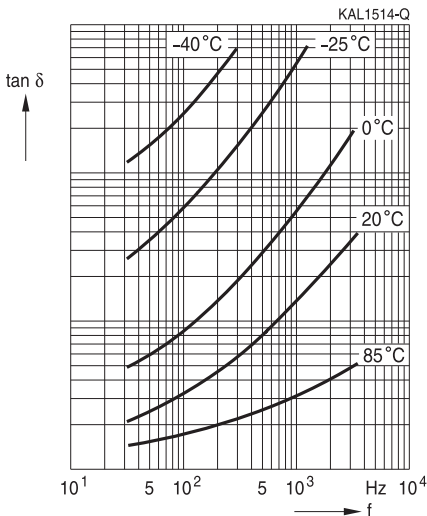

Figure 9  
Typical curves of  $\tan \delta$  as function of frequency for different temperature values

### 3.4 Self-inductance ESL

The self-inductance or equivalent series inductance results from the terminal configuration and the internal design of the capacitor. It is defined by the equivalent series circuit shown in figure 6.

## General technical information

### 3.5 Equivalent series resistance ESR

The equivalent series resistance is the resistive component of the equivalent series circuit. The ESR value depends on frequency and temperature and is related to the dissipation factor by the following equation:

$$ESR = \frac{\tan \delta}{\omega \cdot C_S}$$

ESR    Equivalent series resistance     $\Omega$

$\tan \delta$     Dissipation factor

$C_S$     Series capacitance    F

The tolerance limits of the rated capacitance must be taken into account when calculating this value.

### 3.6 Impedance Z

The impedance of an electrolytic capacitor results primarily from the series circuit formed by the following individual equivalent series components (figure 10):

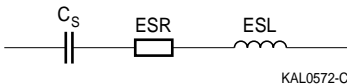

Figure 10

Simplified equivalent circuit diagram of an electrolytic capacitor

- 1) Capacitive reactance  $1/\omega C_S$  of the capacitance  $C_S$
- 2) Dielectric losses and ohmic resistance of the electrolyte, foils and the terminals (ESR)
- 3) Inductive reactance  $\omega ESL$  of the capacitor winding and the terminals.

The inductive reactance  $\omega ESL$  only depends on the frequency, whereas  $1/\omega C_S$  and ESR depend on frequency and on temperature.

The characteristics of the individual resistive and reactive components determine the total impedance of the capacitor. Figure 11 shows typical frequency and temperature characteristics of aluminum electrolytic capacitors.

- Capacitive reactance predominates at low frequencies.
- With increasing frequency, the capacitive reactance ( $X_C = 1/\omega C_S$ ) decreases until it reaches the order of magnitude of the electrolyte resistance.
- At even higher frequencies and unchanged temperatures (see 20 °C curve), the resistance of the electrolyte predominates.
- When the capacitor's resonance frequency is reached, capacitive and inductive reactance mutually cancel each other.
- Above this frequency, the inductive resistance of the winding and its terminals ( $X_L = \omega ESL$ ) becomes effective and leads to an increase in impedance.

## General technical information

The resistance of the electrolyte increases strongly with decreasing temperature. Figure 11 shows that this component already has an effect at low frequencies for low temperature ranges.

Specific impedance values are given in the individual data sheets.

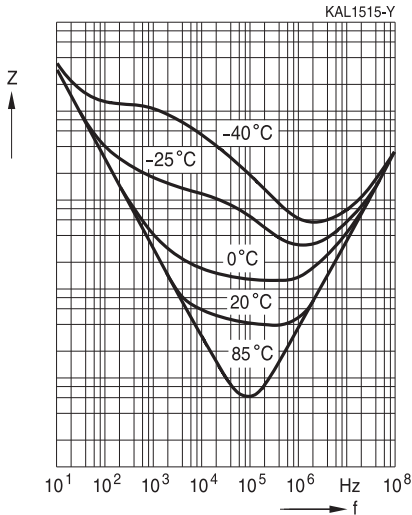

Figure 11  
Example of impedance versus frequency for different temperature values

### 3.7 Leakage current $I_{\text{leak}}$

The special properties of the aluminum oxide layer used as a dielectric mean that a small current (the leakage current) will continue to flow even after a DC voltage has been applied for longer periods.

The value of the leakage current depends on the capacitor design and is also a function of time, the applied voltage and the internal temperature of the capacitor. The initial leakage current level is also affected by the capacitor's history such as its storage conditions and duration.

The leakage current may increase after the reflow soldering process of SMD capacitors. It will then gradually decrease after voltage application.

**General technical information**

**3.7.1 Time dependence of the leakage current**

It is important to know that after application of a voltage, the leakage current decreases with time and reaches a stable value which remains quite constant for a long period of time. This relationship is shown in figures 12 and 13 for two different time scales.

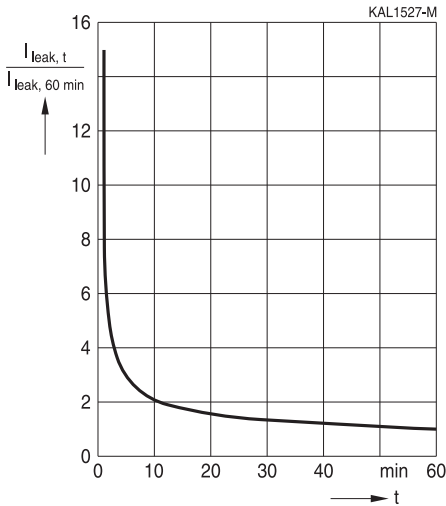

Figure 12  
Normalized leakage current versus time.  
First 60 min after application of the rated voltage at room temperature  
Typical behavior

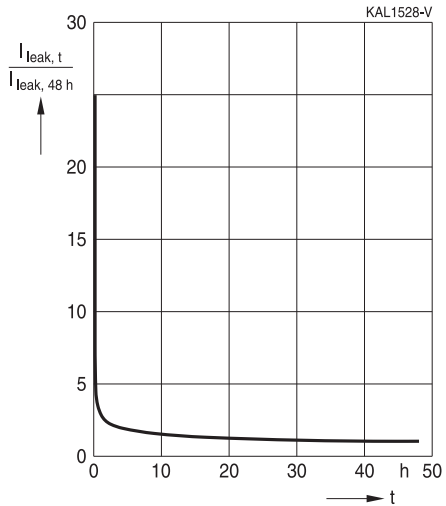

Figure 13  
Normalized leakage current versus time.  
First 48 h after application of the rated voltage at room temperature  
Typical behavior

## General technical information

### 3.7.2 Voltage dependence of the leakage current

The leakage current is an increasing function of the applied voltage  $V_{op}$ , and rises quite strongly when  $V_{op}$  exceeds the rated value  $V_R$ . This behavior is illustrated by the curve shown in figure 14.

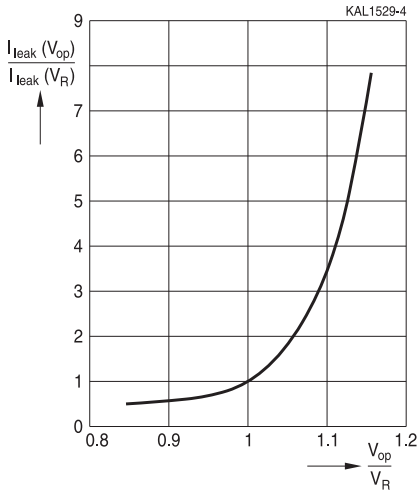

Figure 14  
Normalized initial leakage current versus voltage ratio  $V_{op}/V_R$ . Typical behavior at 60 °C

### 3.7.3 Temperature dependence of the leakage current

The leakage current also increases with temperature. The capacitor internal temperature  $T_{Core}$  must be considered. A typical shape of such a curve is shown in figure 15.

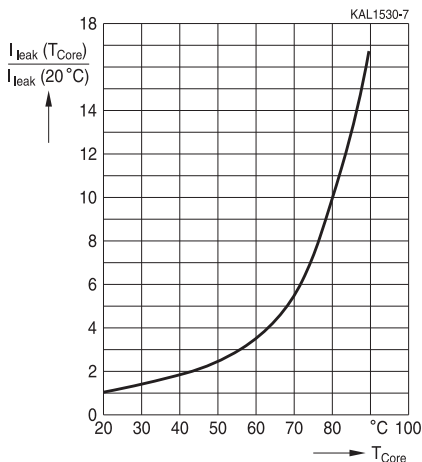

Figure 15  
Normalized initial leakage current versus temperature at rated voltage  $V_R$ . Typical behavior of an 85 °C series

## General technical information

### 3.7.4 Operating leakage current $I_{\text{leak,op}}$

The operating leakage current is the steady-state current (refer also to figure 13) reached during continuous operation. The  $I_{\text{leak,op}}$  of aluminum electrolytic capacitors made by us can be estimated using the following equation.

LL grade:

$$I_{\text{leak,op}} = \frac{0.00025 \mu\text{A}}{\mu\text{F} \cdot \text{V}} \cdot C_{\text{R}} \cdot V_{\text{R}} + 1 \mu\text{A}$$

$I_{\text{leak,op}}$  Operating leakage current

GP grade:

$$I_{\text{leak,op}} = \frac{0.0005 \mu\text{A}}{\mu\text{F} \cdot \text{V}} \cdot C_{\text{R}} \cdot V_{\text{R}} + 3 \mu\text{A}$$

$C_{\text{R}}$  Rated capacitance

$V_{\text{R}}$  Rated voltage

The results refer to the rated voltage  $V_{\text{R}}$  and a temperature of 20 °C.

In accordance with DIN 41240 and DIN 41332, the results obtained for 20 °C must be multiplied by the following factors, to allow for the temperature dependence of the operating leakage current of both General-purpose and Long-life grade capacitors:

Temperature (°C)	0	20	50	60	70	85	125
Factor (typical value)	0.5	1	4	5	6	10	12.5

“SIKOREL” types are an exception to this rule. The following values apply to these:

Temperature (°C)	0	20	55	70	85	105	125
Factor (typical value)	0.7	1	2	3	4	5	8

When the actual operating voltage is below the rated voltage, the operating leakage current is substantially lower:

Operating voltage, in % of the rated voltage $V_{\text{R}}$	20	30	40	50	60	70	80	90	100
Typical values, in % of the operating leakage current $I_{\text{leak,op}}$ (General-purpose grade)	3	6	9	14	18	25	40	50	100
Typical values, in % of the operating leakage current $I_{\text{leak,op}}$ (Long-life grade)	8	14	17	23	30	40	50	70	100

## General technical information

### 3.7.5 Leakage current for acceptance test $I_{leak}$

As the leakage current varies with time and temperature, it is necessary to define reference values for measuring time and temperature. To IEC 60384-4 and IEC 60384-1 the leakage current is to be measured at 20 °C, after the rated voltage has been applied for 5 minutes.

Acceptance testing for leakage current as specified in the particular series can be carried out at any temperature between 15 °C and 35 °C. The permissible limit values are then multiplied by the following conversion factors, with reference to the 20 °C value:

Temperature (°C)	15	20	25	30	35
Factor (guideline value)	0.8	1	1.5	2	2.5

Referee tests are to be carried out at 20 °C.

### 3.7.6 Reforming

To IEC 60384-4, aluminum electrolytic capacitors are to be subjected to a reforming process before acceptance testing. The purpose of this preconditioning is to ensure that the same initial conditions are maintained when comparing and assessing different products.

For this purpose, the rated voltage is applied to the capacitors via a series resistance of approximately 100 Ω for  $V_R \leq 100$  V DC, or 1000 Ω for  $V_R > 100$  V DC, for a period of one hour.

Subsequently, the capacitors are stored under no-voltage conditions for 12 to 48 hours at a temperature between 15 and 35 °C. The leakage current must then be measured, at the latest after 48 hours.

If the capacitors meet the leakage current requirements without preconditioning, this procedure can be omitted.

### 3.7.7 Leakage current behavior after voltage-free storage

The oxide layer of aluminum electrolytic capacitors may deteriorate when they are stored without an externally applied voltage, especially at higher temperatures. Since there is no leakage current to transport oxygen ions to the anode in this case, the oxide layer is not regenerated. The result is that a higher than normal leakage current will flow when a voltage is applied after prolonged storage. As the oxide layer is regenerated in use, however, the leakage current will gradually decline to its normal level.

When designing application circuits, attention must be paid to the fact that after storage the leakage current may be up to 100 times higher than normal during the first few minutes following the application of power. This particular leakage current level increases with temperature and duration of storage.

Refer to the chapter “General technical information, 7.3 Shelf life and storage conditions” on page 30 for more details about the storage conditions and behavior of capacitors.

## General technical information

### 3.8 Insulation and sleeve considerations

The metallic case of capacitors with non-solid electrolyte is not electrically insulated against internal capacitor elements as the case can be connected e.g. through the conductive working electrolyte. Axial leaded capacitors have a direct electrical contact between case and cathode terminal. Single-ended, SMD, snap-in, and screw terminal capacitors have an undefined electrical contact through electrolyte or other parts inside the case.

With exception of SMD components, which have specific soldering and board layout instructions, dummy pins, if available, shall be left potential-free or may be connected to the potential of the negative terminal. Metal parts other than terminals should never make contact to conducting tracks or metal parts of other components.

Capacitors may be either completely or partially covered with sleeving or coating, or not covered at all. It is possible that a change of colour occurs to the coated aluminium case. This material can become brownish after being submitted to high temperatures and this is considered a normal behaviour.

The sleeving can deteriorate depending on the environmental conditions and lose its covering characteristics, e.g.:

- Upon exposure to temperature cycles or high temperature, polyvinyl chloride (PVC) sleeving can become brittle which could potentially lead to cracks
- For polyethylene terephthalate (PET) based sleeving, temperature cycling, exposure to high temperature and high humidity can lead to cracks.

Due to potential deterioration during operation, the standard sleeving or aluminium housing coating must be considered as protection against contact only and does not offer any functional insulation. Thus, covering materials must be considered as electrically non-insulating. If electrical insulation is required, additional measures are necessary.

Special care needs to be taken if the mounting requires electrical insulation, such as e.g.:

- Other components are in touch with capacitors
- Unprotected live wires or PCB tracks are underneath the capacitors
- Capacitors are in contact with the enclosure
- Capacitors are mounted by metal clamps

For such cases, the sleeving material shall be agreed on case by case. Please contact our sales representatives for more details.

#### 3.8.1 Special covering solutions

##### PET cap on terminal side

For capacitors with snap-in terminals we offer a covering version with an additional PET cap on the terminal side, which is placed underneath the shrinking sleeve to increase the creepage distance. Dimensional details are given in the detailed specification of the corresponding capacitor series. While this design offers improved characteristics with respect to creepage distances, it is not to be considered as functional insulation.

For additional special insulation and covering solutions please contact our sales representative.

## General technical information

### 3.8.2 Breakdown strength and insulation resistance of standard sleeve

Upon delivery many of our aluminum electrolytic capacitors are enveloped by a shrinking sleeve. As reference, the breakdown strength for a new sleeve is typically greater than 2500 V AC or 3500 V DC and the insulation resistance is at least 100 M $\Omega$ . IEC 60384-4 specifies corresponding test methods.

Due to potential deterioration during operation, the standard sleeving must be considered as protection against contact only and does not offer any functional insulation. For details refer to chapter "General technical information, 3.8 Insulation and sleeve considerations".

## 4 Ripple current considerations

### 4.1 General

The term ripple current is used for the root-mean-square (RMS) value of the alternating current that flows through a device as a result of any pulsating or ripple voltage. Power losses resulting from this ripple current induce self-heating of the capacitor. The maximum permissible value of the ripple current depends on the ambient temperature, the equivalent series resistance (ESR) at the frequency of the AC signal, the thermal resistance, which is mainly determined by the surface area of the capacitor (i.e. heat dissipation area) and the applied cooling. Moreover, it is restricted by the ripple current capability of the contact elements.

Please note that especially in cases of very high ripple current load a good and stable electrical and thermal connection between contact elements of the capacitor and the input lead of the application (e.g. busbar in case of screw terminal capacitors) is essential. Losses resulting in an additional heating up of the capacitor and the environment leading to enhanced deterioration must be avoided. For details please contact our sales offices.

The rated ripple current ( $I_{AC,R}$ ) is usually specified at the upper category temperature and the reference frequency.

As thermal stress has a decisive effect on the capacitor's life expectancy, the heat generated by the ripple current is an important factor affecting the useful life. For more details, refer to chapter "General technical information, 5.3 Calculation of useful life" on page 23.

These thermal considerations imply that it may be necessary under certain circumstances to select a capacitor with a higher voltage or capacitance rating than would normally be required by the respective application.

### 4.2 Frequency dependence of the ripple current capability

The equivalent series resistance of aluminum electrolytic capacitors varies with the frequency of the AC signal. As a result, the ripple current capability, which is determined by the induced power loss, is also a function of the frequency. In the individual data sheets, the ripple current capability of the capacitors is generally referred to a frequency of 100 Hz, 120 Hz, 10 kHz or 100 kHz. Depending on the main applications, other frequencies are also possible.

### 4.3 Temperature dependence of the ripple current capability

According to the Arrhenius law, the capacitor's life expectancy is strongly related to its core temperature. Hence, the maximum permissible temperature rise above ambient temperature and the associated maximum permissible ripple current depend on the ambient temperature.

## General technical information

The data sheets specify the maximum permissible ripple current for the upper category temperature for each capacitor type. For most types, the maximum values of the ripple current ( $I_{AC,max}$ ) for continuous operation at ambient temperatures below the upper category temperature (e.g. +60 °C or +85 °C) have also been included for the purpose of comparison.

### 5 Useful life

Useful life is defined as the life achieved by the capacitor without exceeding a specified percentage of failures. Total failures or failures due to parametric variation are considered to constitute the end of the useful life. The “requirements” in the respective “Specifications and characteristics in brief” chart for each series define the permissible range of parametric variation for the specified useful life.

Depending on the circuit design, device failure due to parametric variation does not necessarily imply equipment failure. This means that the actual life of a capacitor may be longer than its specified useful life. Data on useful life were obtained from accelerated tests and from experience gained in the field.

The useful life can be prolonged by operating the capacitor at loads below its rated voltage, current or ambient temperature and by appropriate cooling measures. In addition to the standard series types, we can offer types with useful life ratings specially matched to customer specifications.

The useful life of a selected capacitor under operating conditions other than those indicated in the data sheets can be determined by consulting the “AlCap Useful Life Calculation” design tool on our website, or by the use of the respective useful life graph, if such a graph is published in this data book for the requested series. For more details, refer to chapter “General technical information, 5.3 Calculation of useful life” on page 23.

The useful life data published in this data book and the calculation results obtained are typical values and are intended for guidance purposes only. The useful life does not constitute a warranty of any kind or a prolongation of the agreed warranty period.

#### 5.1 Load conditions

The useful life of capacitors with liquid electrolytes is defined on the basis of the following load conditions:

- Rated voltage
- Rated ripple current (the peak value of the AC voltage superimposed on the DC voltage must not exceed the rated voltage)
- Rated temperature

#### 5.2 Cooling

Unless otherwise specified, the useful life values stated in the data sheets apply to aluminum electrolytic capacitors with natural cooling, i.e. the heat generated in the winding is dissipated through the case, assuming natural convection. It is possible to increase the permissible ripple current and/or prolong the useful life by means of additional cooling measures (e.g. a heat sink or forced ventilation). Conversely, impaired cooling (e.g. due to closely packed capacitor banks, thermally insulating sealing and vacuum) will reduce the useful life.

## General technical information

### 5.2.1 Forced air cooling

Under natural convection, the thermal resistance between the case and the surrounding air makes the greatest contribution to the total thermal resistance. In case of forced air cooling, this thermal resistance is reduced due to improved heat dissipation at the case.

The "AlCap Useful Life Calculation" design tool allows the effect of forced air cooling on the useful life to be simulated by specifying the velocity of the ambient air.

Useful life graphs are included for some series in this data book. In this case, rated ripple current multipliers are used to calculate the useful life as a function of the air velocity on the basis of the respective graphs. Contact us for the specific multiplier values of a particular capacitor.

### 5.2.2 Base cooling with heat sink

As a large amount of heat is dissipated through the base of the case, a heat sink connected to the capacitor base provides the most efficient cooling. We offer specially designed versions of high-voltage capacitors with screw or snap-in terminals that can be mounted on a heat sink in order to ensure optimal heat transfer from the heat generation area via the base of the case to the heat sink.

## General technical information

### Screw terminal capacitors

The special design comprises:

- In general, winding elements and cans of screw terminal capacitors are designed for a low inner thermal resistance in order to ensure an optimal thermal connection between the winding element and base. The resulting good heat transfer from the heat generation point to the outside provides very efficient cooling, especially with heat-sink mounting.
- Two thermal pads at the base. The first (thickness 0.5 mm) closes the air gap in the base area not covered by the shrinking sleeve. The second (thickness 0.2 mm) provides the electrical insulation of the case.
- A minimized tolerance ( $\pm 0.35$  mm) of the overall length  $l_1$  of the capacitor (figure 16) avoids unwanted mechanical forces on the terminals, especially when several capacitors are mounted between heat sink and bus bar.
- A case with an extra groove near the base for ring-clamp mounting (recommended accessory B44030A0165B ... A0190B). The clamp ensures optimal pressing of the base to the heat sink.

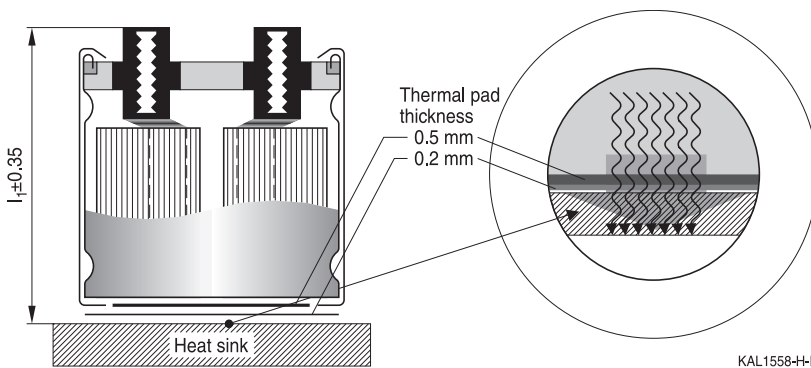

KAL1558-H-E

Figure 16  
Heat-sink mounting for capacitors with screw terminals

If the base (case bottom) of a high-voltage screw terminal capacitor is cooled by a heat sink to keep it at constant temperature, the ripple current capability increases significantly compared to natural convection. The gain of ripple current capability (or useful life at the same ripple load) depends strongly on the length-to-diameter ratio ( $l/d$ ) of the respective capacitor.

The typical gain of rated ripple current capability  $I_{AC,R}$  (base cooling) /  $I_{AC,R}$  (natural convection) as a function of the length-to-diameter ratio is as follows:

Length-to-diameter ratio ( $l/d$ )	1.3	1.45	1.6	1.8	2.0	2.4	2.8
$I_{AC,R}$ (base cooling) / $I_{AC,R}$ (natural convection)	1.7	1.65	1.6	1.55	1.5	1.45	1.4

It is assumed that the base-cooling equipment is sufficient to ensure a constant base temperature.

## General technical information

### Snap-in capacitors

In comparison to standard snap-in capacitors the special design comprises:

- Winding elements and cans designed for a low inner thermal resistance in order to ensure an optimal thermal connection between the winding element and base. The resulting good heat transfer from the heat generation point to the outside provides very efficient cooling, especially with heat-sink mounting.
- A minimized overall length tolerance ( $\pm 0.2$  mm) of the capacitor is ensured by a special can design involving a length adjustment process. This allows thinner thermal pads to be used for connecting a capacitor bank to the heat sink, which leads to a reduced thermal resistance as well as lower costs.
- A reinforced capacitor can provides long-term stable dimensions during operation in order to ensure a constant low thermal resistance.
- The alternative versions with and without sleeve allow simple and effective connection of the capacitor base to the heat sink, providing a cost-optimized solution with reduced thermal resistance.

### 5.3 Calculation of useful life

#### “AlCap Useful Life Calculation” design tool on the TDK Electronics website

For convenient calculations of the useful life, we provide the “AlCap Useful Life Calculation” design tool on its website: [www.tdk-electronics.tdk.com/alcap](http://www.tdk-electronics.tdk.com/alcap)

It applies to all the high-voltage snap-in and screw terminal capacitor series published in this data book. This application allows users to determine power losses, resulting hot-spot temperatures and corresponding useful life expectancies at customer-specific load conditions on the basis of the individual electrical and thermal characteristics of the respective capacitors.

In addition, it is possible to calculate useful life expectancies based on temperatures measured by the user in the application. For that purpose we offer capacitors which are equipped with thermocouples in the hot spot. The reference is always the measured ambient temperature in close proximity to the capacitor. For a better evaluation it can be helpful to perform further thermal measurements on the capacitor wall or in case of screw terminal capacitors on the contact elements or on the busbars. For details please contact our sales offices.

#### Calculation of useful life on the basis of useful life graphs

Useful life graphs are published in this data book for all low-voltage capacitor series as well as for all single-ended and axial-lead capacitor series.

The tables in the individual data sheets list the rated ripple current  $I_{AC,R}$  for the upper category temperature (e.g.  $+85$  °C,  $+105$  °C,  $+125$  °C) and for a specified frequency  $f$  (e.g. 100 Hz). The useful life for known ripple current loads and ambient temperatures is determined from the useful life graphs as follows:

The quotient  $I_{AC} / I_{AC,R}$  of the required ripple current is determined at the given ambient temperature and the rated ripple current at the upper category temperature. The corresponding useful life value is given by the curve passing through the respective ambient temperature and the current quotient coordinates. Alternatively, it can be interpolated if none of the useful life curves passes directly through these coordinates.

## General technical information

The frequency dependence of the ripple current was not taken into account in the procedure described above: it must be introduced into the calculation in the form of an additional factor.

For this purpose, curves of the conversion factor  $I_{AC,f} / I_{AC,100\text{ Hz}}$  versus the frequency  $f$  are given in the individual data sheets.

The following examples illustrate the calculation procedure using the data of a capacitor of the B41456 / B41458 series. For this series, the upper category temperature is +85 °C. As an example, a capacitor with the following ratings was selected from the data sheets.

### Series B41456 / B41458

$C_R$ 100 Hz 20 °C $\mu\text{F}$	Case dimensions $d \times l$ mm	$\text{ESR}_{\text{typ}}$ 100 Hz 20 °C $\text{m}\Omega$	$\text{ESR}_{\text{max}}$ 100 Hz 20 °C $\text{m}\Omega$	$Z_{\text{max}}$ 10 kHz 20 °C $\text{m}\Omega$	$I_{AC,\text{max}}$ 100 Hz 40 °C A	$I_{AC,R}$ 100 Hz 85 °C A	Ordering code (composition see below)
$V_R = 100\text{ V DC}$							
22000	64.3 x 105.7	5.0	10	10	45	17	B4145*B9229M60#

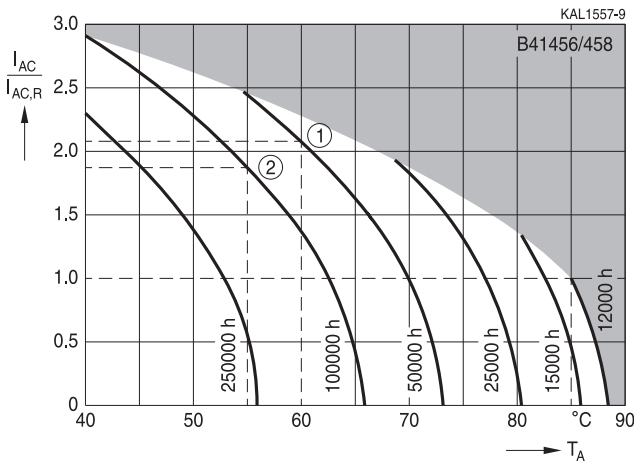

Figure 17

Useful life depending on ambient temperature  $T_A$  under ripple current operating conditions (series B41456 / B41458)

### Example 1 – Calculating the useful life

The following load conditions are assumed.

Ripple current	40 A
Frequency	300 Hz
Ambient temperature	60 °C

## General technical information

The corresponding useful life is determined as follows.

The equivalent ripple current for 100 Hz ( $I_{AC,100Hz}$ ) is calculated using the frequency factor (1.12 in this case, see the B41456 / B41458 series "Frequency factor of permissible ripple current  $I_{AC}$  versus frequency  $f$ "):

$$I_{AC,100Hz} = \frac{40 \text{ A}}{1.12} = 35.7 \text{ A}$$

The ripple current factor is then calculated using the resulting equivalent 100 Hz ripple current.

$$\frac{I_{AC,100Hz}}{I_{AC,R}} = \frac{35.7 \text{ A}}{17 \text{ A}} = 2.1$$

The useful life curve passing through the coordinates for the ripple current factor (2.1) and the ambient temperature (60 °C) indicates the useful life that can be expected:

50 000 h (see ① figure 17).

### Example 2 – Determining whether a capacitor achieves the required useful life at a specific ripple current load

In many applications, aluminum electrolytic capacitors are subjected to ripple currents of varying frequencies.

The equivalent total ripple current load is calculated below for the following given RMS values:

Current 1: $I_{AC,RMS}$ at 300 Hz	34.2 A
Current 2: $I_{AC,RMS}$ at 3 kHz	12.4 A
Ambient temperature	55 °C
Required useful life	100 000 h

The first step is to calculate the equivalent 100 Hz values  $I_{AC,1}$  and  $I_{AC,2}$  for the two current values (frequency factors given for the B41456 / B41458 series "Frequency factor of permissible ripple current  $I_{AC}$  versus frequency  $f$ ") and subsequently the total value  $I_{AC,total}$ :

$$\text{Equivalent 100 Hz ripple current 1: } I_{AC,1} = \frac{34.2 \text{ A}}{1.12} = 30.5 \text{ A}$$

$$\text{Equivalent 100 Hz ripple current 2: } I_{AC,2} = \frac{12.4 \text{ A}}{1.17} = 10.6 \text{ A}$$

$$\begin{aligned} \text{Total equivalent 100 Hz current: } I_{AC,total} &= \sqrt{I_{AC,1}^2 + I_{AC,2}^2} \\ I_{AC,total} &= \sqrt{(30.5 \text{ A})^2 + (10.6 \text{ A})^2} = 32.3 \text{ A} \end{aligned}$$

$$\text{According, the ripple current factor is: } \frac{I_{AC,total}}{I_{AC,R}} = \frac{32.3 \text{ A}}{17 \text{ A}} = 1.9$$

The useful life curve that coincides with the respective coordinates 1.9 on the Y-axis (ripple current factor) and 55 °C on the X-axis (ambient temperature) indicates a useful life of 100000 h (see ② figure 17). The required useful life is thus achieved.

## General technical information

### 6 Capacitor bank design

In many applications, a bank composed of several capacitors connected in parallel and/or in series is used. Such arrangements are needed to increase:

- Capacitance (parallel connection)
- Current capability (parallel connection)
- Voltage capability (series connection)

If both parallel and series connections are necessary, there are two possible structures for capacitor banks, which are shown in figure 18, a) series-parallel and b) parallel-series.

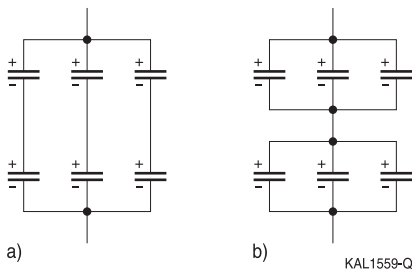

Figure 18  
Possible bank structures – example:  
a) series-parallel connection and  
b) parallel-series connection

The above structures have different properties, especially with respect to balancing the capacitor voltage (see also CLC/TR 50454). The series-parallel connection requires a separate balancing device (for example a resistor) for each capacitor, while in the parallel-series arrangement the whole group of capacitors connected in parallel can share the same device. The results of failure of one capacitor in the bank are also different. In the following, the very rare but most interesting worst case scenario is considered when a capacitor fails due to a short circuit.

In the case of the series-parallel structure, such failure first affects the remaining capacitors in the same branch and subjects them to an overvoltage, which can then also cause them to fail. This can result in either an open circuit or a short circuit for the affected branch, but without spreading to the remaining branches.

In the case of the parallel-series connection, the remaining capacitors in the same group firstly discharge to the failed part. The other group (or groups) is then exposed to the full DC link voltage and can also fail as a result of the applied overvoltage. The whole bank can be damaged as a result.

When a capacitor bank is being built, it is recommended that all its individual capacitors:

- are subjected to equal stresses (voltage, current, ambient temperature and cooling conditions) as far as possible, and
- have the same date code.

This will assure a similar aging rate for all capacitors and minimize the risk of failures.

## General technical information

Voltage stress equalization in series-connected capacitors merits particular concern. The cause of potential voltage asymmetry is the spread of leakage currents versus voltage characteristics. This spread is unavoidable and can be extensive. The effective voltage unbalance is reduced by the non-linearity of the leakage current characteristic near the rated voltage (the current rises quickly with a small increase of voltage). Nevertheless, it is widely accepted that some additional balancing measures are needed.

The most popular voltage balancing method is the use of a resistive voltage divider as shown in figure 19.

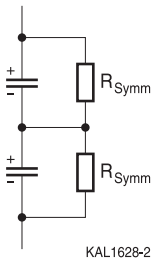

Figure 19  
Popular passive voltage balancing method using a resistor divider

In order to assure the necessary voltage symmetrization, the resistor value  $R_{\text{Symm}}$  must be relatively low and have a tight tolerance (as this directly affects the precision of the voltage equalization). The low resistance results from the typical recommendation that the current flowing through the resistor should be approximately 20 times higher than an expected leakage current. This requirement leads to the following rule-of-thumb formula for the resistance:

$$R_{\text{Symm}} = 100 \text{ M}\Omega \cdot \frac{1}{\sqrt{N_p} \cdot C_R} \mu\text{F}$$

where  $N_p$  is the number of capacitors connected in parallel for the configuration shown in figure 18, and  $C_R$  is the rated capacitance value of a single capacitor used in the bank.

Quite significant power losses are then generated in the balancing resistors, and this also occurs in cases where the spread of leakage currents in the bank is negligibly low.

It should be noted that many other balancing techniques using transistors (in analog or switching mode) are also available. Quite an attractive method using transistors (field-effect or bipolar) in a push-pull arrangement is shown schematically in figure 20.

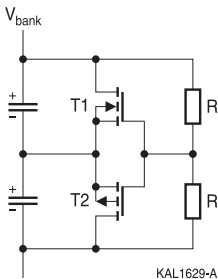

Figure 20  
Active voltage balancing method using a push-pull transistor arrangement

## General technical information

It is important to note that the function of the resistors R here is only to provide the reference voltage level for transistors T1, T2 (equal approx.  $\frac{1}{2} V_{\text{bank}}$ ). Thus their value should be quite high, and the resulting power losses are practically negligible. The capacitor voltages then remain within the range:  $\frac{1}{2} V_{\text{bank}} \pm V_T$  (where  $V_T$  is the transistor threshold voltage), so that the maximum voltage difference between capacitors can reach approximately  $2 \cdot V_T$ .

This circuit has two important advantages over the passive method shown in figure 19. If the leakage characteristics of the capacitors are very similar, then almost no current flows (and no losses are incurred) in the transistors. If the leakage currents are not equal, then only one of the transistors supplies the current difference  $\Delta I_{\text{leak}}$ , which means a much lower loss level than in the method shown in figure 19.

The balancing measures described above may be omitted in cases where the total capacitor bank voltage  $V_{\text{bank}}$  to be applied is substantially lower than the sum of the rated voltages of the series-connected capacitors. Experience has shown that this is possible if the total  $V_{\text{bank}}$  does not exceed a value of  $0.8 \cdot N_s \cdot V_R$  (where  $N_s$  is the number of capacitors in series). Although some voltage asymmetry may be observed in such cases, this does not lead to capacitor failure.

## 7 Climatic conditions

Limits must be set for the climatic conditions to which electrolytic capacitors are subjected (in part for reasons of reliability and in part due to the variation of the electrical parameters with temperature). It is therefore important to observe the permissible minimum and maximum temperatures and the humidity conditions stated in coded form as IEC climatic category, for details refer to chapter "General technical information, 7.4 IEC climatic category" on page 31. The IEC categories are given for each type in the corresponding data sheet.

### 7.1 Minimum permissible operating temperature (lower category temperature)

The conductivity of the electrolyte diminishes with decreasing temperature, causing an increase in electrolyte resistance. This, in turn, leads to increasing impedances and dissipation factors (or equivalent series resistances). For most applications, these increases are only permissible up to a certain maximum value. Therefore, minimum permissible operating temperatures are specified for aluminum electrolytic capacitors. These temperature limits are designated "lower category temperature" and are also part of the IEC climatic category.

It should be emphasized that operation below this temperature limit will not damage the capacitor. Especially when a ripple current flows through the device, the heat dissipated by the increased equivalent series resistance will raise the capacitor temperature so far above the ambient temperature that the capacitance will be adequate to maintain equipment operation.

## General technical information

The typical response of impedance and capacitance of a capacitor with a lower category temperature of  $-25\text{ }^{\circ}\text{C}$  is illustrated in figures 21 and 22.

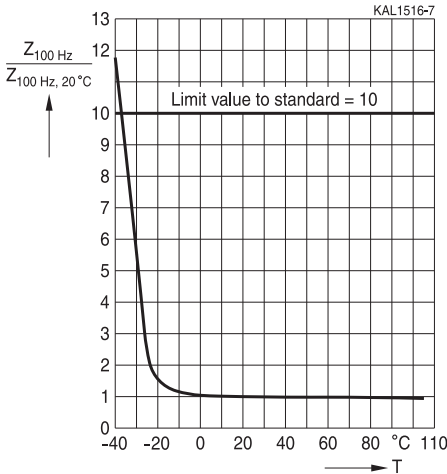

Figure 21  
Temperature characteristics of impedance Z  
Typical behavior

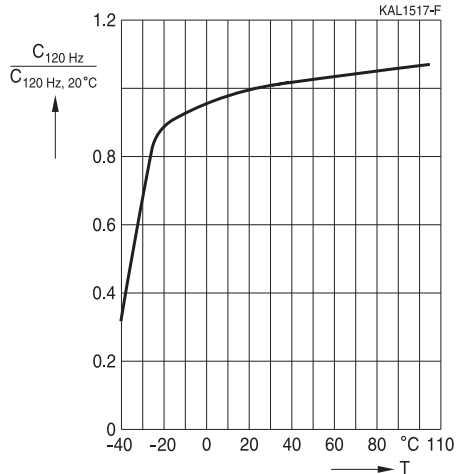

Figure 22  
Temperature characteristics of capacitance C  
Typical behavior

IEC 60384-4 specifies that electrical values such as ESR, impedance and capacitance are measured after the capacitor has reached thermal equilibrium; prolonged storage at low temperatures can cause ESR and impedance to increase and capacitance to decrease beyond values obtained under the standard test conditions.

### 7.2 Maximum permissible operating temperature (upper category temperature)

The upper category temperature is the maximum permissible ambient temperature at which a capacitor may be continuously operated. It depends on the capacitor design and is stated in the respective IEC climatic category. If this limit is exceeded the capacitor may fail prematurely.

For some type series, however, operation at temperatures above the upper category temperature is permissible for short periods of time. Details are given in the individual data sheets.

Useful life and reliability depend to a large extent on the capacitor's temperature. Operation at the lowest possible temperature will increase both useful life and reliability and is therefore recommended. For the same reason, it is advisable to select the coolest possible position within the equipment as a location for aluminum electrolytic capacitors.

## General technical information

### 7.3 Shelf life and storage conditions

#### 7.3.1 Shelf life

Our aluminum electrolytic capacitors can be stored voltage-free at the upper category temperature for a period of 1000 h. After preconditioning according to the procedure described in chapter "General technical information, 3.7.6 Reforming" on page 17, the capacitors will fulfill the following requirements at 20 °C:

$$|\Delta C/C| \leq 10\% \text{ of initial values}$$

$$\tan \delta \leq 1.2 \text{ times initial specified limit}$$

$$I_{\text{leak}} \leq \text{initial specified limit}$$

For normal storage conditions, where the ambient temperature is lower and the storage time is significantly longer, observe the following instructions.

#### 7.3.2 Storage conditions

Capacitors are often stored voltage-free either in original packing or already mounted in a circuit (final application or spare part assembly).

Our aluminum electrolytic capacitors can be stored without damage at ambient temperatures ranging from typical -55 °C up to the upper category temperature.

However, it must be taken into account that storage at elevated temperatures will affect leakage current, useful life and solderability. In order to avoid impairing these properties, capacitors should be stored between +5 °C and +35 °C and at a relative humidity of  $\leq 75\%$ . Long-term storage at high temperatures and in an environment with high humidity should be avoided. Likewise, one should avoid storing the capacitors in environments that contain halogenated gases (and other hazardous gases), sprinkling water or oil as well as exposure of the capacitors to direct sunlight, ultraviolet rays or other radiation.

If not otherwise specified, our aluminum electrolytic capacitors can be stored voltage-free at above stated conditions (from +5 °C to +35 °C, relative humidity  $\leq 75\%$ ) for at least two years; capacitors of the SIKOREL series can be stored for as long as 15 years under these conditions. Within these storage periods the capacitors can be operated at their rated voltage directly after being taken out of storage. It is recommended to mount the capacitors in the application within one year of delivery in order to prevent any problems with solderability of capacitors on PCBs.

If the capacitors have been stored at temperatures above +35 °C or for longer than abovementioned periods, it is necessary to consider whether the application circuit is able to tolerate high initial leakage currents. If this is not the case, one should perform the special reforming procedure (see also chapter "General technical information, 3.7.6 Reforming" on page 17) in order to enable normal operation in the application or to continue the storage. Capacitors that have been stored in their original packing should be reformed according to the standards by applying rated voltage via a series resistance of approximately 100  $\Omega$  (for  $V_R \leq 100$  V DC) or 1000  $\Omega$  (for  $V_R > 100$  V DC) for a period of one hour. Finished or semi-finished goods that have been stored with mounted capacitors should be connected to an appropriate input voltage source for one hour. If the circuits contain capacitors connected in series, it should be considered to increase the voltage incrementally.

## General technical information

After severe or extremely long storage periods capacitors are not robust enough to recover without any negative effects on their electrical properties, and also a reduced useful life is to be expected. In such cases, the charging current must be limited after applying voltage to prevent the capacitor from overheating.

For more details about the leakage current behavior during storage refer to the chapter “General technical information, 3.7.7 Leakage current behavior after voltage-free storage” on page 17.

### 7.4 IEC climatic category

The permissible climatic stress on an aluminum electrolytic capacitor is given by the respective IEC climatic category. To IEC 60068-1, the climatic category comprises 3 groups of numbers, separated by slashes.

*Example:* 40 / 085 / 56

1st group: Lower category temperature (temperature limit) denoting the test temperature for test A (cold) to IEC 60068-2-1.

2nd group: Upper category temperature (temperature limit) denoting the test temperature for test B (dry heat) to IEC 60068-2-2.

3rd group: Number of days, the duration of test Cab (damp heat, steady state) at a relative humidity of 93 +2/-3% and an ambient temperature of 40 °C, to IEC 60068-2-78.

## 8 Flammability

### 8.1 Passive flammability

Under the influence of high external energy, such as fire or electricity, the flammable parts of capacitors may get inflamed. Clause 4.38 of the relevant specification IEC 60384-1 (Fixed capacitors for use in electronic equipment – Part 1: Generic specification) refers to the standard IEC 60695-11-5 (Test flames – Needle-flame test method – Apparatus, confirmatory test arrangement and guidance) for testing the passive flammability. IEC 60384-1 summarizes severities and requirements for different categories of flammability. In general category C is met by most of our aluminum electrolytic capacitors.

### 8.2 Active flammability

In rare cases the component may ignite caused by heavy overload or some capacitor defect. One reason could be the following: During the operation of an aluminum electrolytic capacitor with non-solid electrolyte, there is a small quantity of hydrogen developed in the component. Under normal conditions, this gas permeates easily out of the capacitor. But under exceptional circumstances, higher gas amounts may develop and may catch fire if a sparking would occur at the same time.

As explained above a fire risk can't be totally excluded. Therefore, it is recommended to use special measures in critical applications (e.g. additional encapsulation of the equipment for mining applications).

## General technical information

### 9 Mechanical stress resistance

#### 9.1 Vibration resistance

The vibration resistance specifications are defined in the individual data sheets.

#### 9.2 Operating altitude

The standard IEC 60384 (part -1 and -4) refers to a test that can be used to verify the usability of aluminum electrolytic capacitors at high altitudes. The test should follow the method described in the general environmental standard IEC 60068-2-13 (test M: low air pressure). In this test, the capacitors are tested at a pressure of approx. 8 kPa (which corresponds to an altitude of approx. 17 km above sea level).

#### 9.3 Robustness of terminals

The mechanical strength of terminals and leads is defined in the respective detail specifications. Terminals of the capacitors in this data book also meet the test conditions specified by IEC 60068-2-21.

For tightening torques for screw terminals, refer to chapter "General technical information, 11.2 Mounting torques" on page 33.

### 10 Maintenance

CENELEC R040-001 (chapter 1 to 19) provides general information on applications in which aluminum electrolytic capacitors are used. The most important subjects are: safety requirements and measures, installation in equipment with inherent heating, destruction by overpressure, fire hazards, parallel and series capacitor circuits.

Make periodic inspections for the capacitors that have been used in the devices for industrial applications. Before the inspection, make sure to turn off the power supply and carefully discharge the electricity of the capacitors. To check the capacitors, make sure of the polarity when measuring the capacitors by using a volt-ohm meter, for instance. Also, do not apply any mechanical stress to the capacitor terminals. The following items should be checked by the periodic inspections:

- Significant damage to appearances: venting, electrolyte leakage, etc.
- Electrical characteristics: leakage current, capacitance, dissipation factor and other characteristics prescribed in the catalogs or product specifications.

If any of the above is found, replace it or take any other proper measure.

## General technical information

### 11 Mounting

#### 11.1 Mounting positions of capacitors

Screw terminal capacitors, with pressure relief vent in the cover disk, must not be mounted with terminals facing down unless otherwise specified.

Multi-pin capacitors with pressure relief vent on the can base must not be mounted with terminals facing up unless otherwise specified.

The recommended mounting positions are shown in figure 23.

Example:

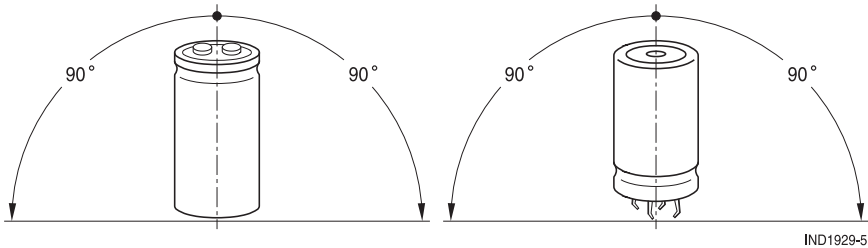

Figure 23  
Recommended range of mounting positions

For screw terminal capacitors, in case of horizontal mounting, the pressure relief vent in the cover disk should be at the "12 o'clock" position. Nevertheless, upright mounting is recommended.

Mounting positions other than recommended may result in serious damage in the application during operation due to possible electrolyte leakage in the case of venting.

#### 11.2 Mounting torques

The torque limits listed below represent the maximum permissible torque that may be applied to the screw terminals or mounting studs of the capacitor itself. Some accessory parts used (nuts, washers, etc.) may have lower torque limits.

Thread	Maximum torque (Nm)
M5	2.5 (thread depth $t \geq 8$ mm)
M6	4.0 (thread depth $t \geq 9.5$ mm)
M12	10.0

## General technical information

### 11.3 Mounting considerations for single-ended capacitors

The internal structure of single-ended capacitors might be damaged if excessive force is applied to the lead wires. Stresses like push, pull, bend etc. might cause increased leakage current, intermittent capacitance, electrolyte leakage or open/short circuit, due to rupture of terminals or internal elements.

Pay attention to the following cautions:

- Do not move the capacitor after soldering to PC board.
- Do not pick up the PC board by holding the soldered capacitor.
- Do not insert capacitor on the PC board with a hole space different to specified lead space. Take the position of the pressure relief device into consideration when designing the PC board layout.

Example:

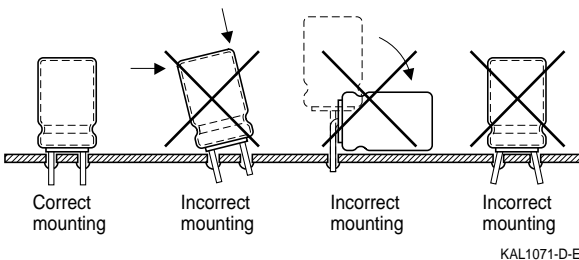

Figure 24  
Mounting considerations for single-ended capacitors

### 11.4 Potting and gluing of aluminum electrolytic capacitors

- Potting compound or glue must be free of halogens and other corrosive substances. Potting compound must not cover the whole capacitor surface.
- The potting and gluing materials must not impair the function of the capacitor's pressure relief device.
- Potting compounds or glue may heat up capacitors while curing. The upper category temperature should not be exceeded.
- Exposure to high temperatures may damage the capacitor sleeve.
- Depending on the duration a temperature rise during the curing process may lead to an increased leakage current of the capacitors when the application is switched on first time. The life span of the capacitors usually is not affected.
- Potting compounds usually have a low thermal conductivity, which may adversely affect the emission of heat from the capacitors during operation. Increased heating up may shorten the life span of the capacitors.
- When warmed up the potting compound may exert pressure on the capacitor. Such pressure shall not exceed 20 bar.
- The capacitor sleeve may contain substances that on a long-term basis can react aggressively with the potting compound or glue.

## General technical information

- If gluing is the only mechanical attachment, then the mechanical stability of the shrinking sleeves is the determining factor for the stability of the attachment of the capacitor.

### 11.5 Soldering

Excessive soldering time or temperature and solder materials can negatively affect the capacitor's characteristics and cause damage to the sleeve. Therefore:

- Avoid contact of the soldering iron to the sleeve.
- Ensure that soldering conditions are within the limits prescribed in the product specification below.
- Use only halogen-free flux and solder products.

Resistance of aluminum electrolytic capacitors to soldering heat is specified according to IEC 60384-4, which refers to clause 4.14 of IEC 60384-1 for further details. Our aluminum electrolytic capacitors meet the following terms:

Test conditions: No pre-drying  
IEC 60068-2-20, Test Tb, method 1 (solder bath)  
(260 ± 3) °C, (10 ± 1) s

Requirements: No visible damage, legible marking  
| $\Delta C/C$ | ≤ 5% of initial value

Not applicable to capacitors with screw terminations or other terminations not designed to be soldered, as stated in the detail specification.

### 11.6 Cleaning agents

Cleaning agents may cause serious damage if allowed to come into contact with aluminum electrolytic capacitors. These solvents may dissolve or decompose the insulating film and reduce the insulating properties to below the permissible level, if applicable. The capacitor seals may be affected and swell, and the solvents may even penetrate them. This will lead to premature component failure.

Because of this, measures must be taken to prevent electrolytic capacitors from coming into contact with cleaning agents and solvents to clean printed circuit boards after soldering the components, or to remove flux residues.

As a general rule, capacitors with Polyethylene terephthalate (PET) based sleeve are not suggested to be washed with any cleaning agent either solvent based or aqueous. Aqueous residuals from the washing treatment can induce a slow hydrolytic degradation of the polymer at elevated temperature.

Polyvinyl chloride (PVC) based sleeve can be treated with cleaning agents either aqueous or solvent based (but halogen-free).

#### Halogen-free solvents:

Ethanol (methylated spirits)	Isobutanol
Propanol	Propylenglycoether
Isopropanol	Diethyleneglycoldibutylether

## General technical information

### Critical solvents:

The following list contains a selection of critical halogenated hydrocarbons and other solvents frequently used, partially in pure form, partially in mixtures with other solvents, as cleaning agents in the electrical industry.

Trichlorotrifluoroethane (trade names e.g. Freon, Kaltron, Frigene)	Chloroform
Trichlorethylene	Carbontetrachloride
Trichloroethane (trade names e.g. Chlorothene, Wacker 3 x 1)	Acetone
Tetrachloroethylene (trade name: Per)	Ethylacetate
Methylenchloride	Butylacetate
Methylethylketone	

However, printed-circuit board cleaning equipment is available which uses halogenated solvents but is designed to enable thorough cleaning in a very short time (four-chamber ultrasonic cleaning process). Furthermore, the processes used ensure that virtually no solvent remains on the cleaned parts.

This means that the general warning against the use of halogenated cleaning solvents on aluminum electrolytic capacitors can be qualified if the following conditions are met:

1. The cleaning period in each chamber must not exceed 1 minute.
2. The final cleaning stage must use a solvent vapor only. The temperature must be 50 °C or lower.
3. Adequate drying must be ensured immediately after the cleaning process in order to evaporate any condensed residual solvent.
4. Contaminated cleaning agents must be regularly replaced as specified by the manufacturer and by legal regulations.

## 12 Fumigation

International shipments of products are subjected in many countries to a fumigation treatment using halogenated chemicals (e.g. methyl bromide) in order to control insect infestation, particularly when wooden packaging is used. The halogenated gas can penetrate cardboard boxes, polymer bags or other packaging materials and come into direct contact with equipment or components contained within and may cause corrosion of aluminum electrolytic capacitors. The halogenated gas can also penetrate the seals of aluminum electrolytic capacitors and may cause internal corrosion, possibly resulting in an open-circuit after the equipment has been put into operation.

## General technical information

### 13 Marking of the capacitors

The example below shows how the snap-in capacitors are marked:

	LL	Manufacturer (company logo)
B43512-A9108-M		Grade (only on LL grade capacitors)
1000 $\mu$ F (M)		Part number (ordering code)
400 V-	40/085/56	Rated capacitance, tolerance (in coded form)
		Rated voltage, climatic category (to IEC or coded as explained below)
	11.18	Month and year of production

KAL2028-R-E

Figure 25  
Marking example

Capacitance tolerances are coded to IEC 60062 using the codes shown below:

Code letter	Capacitance tolerance	Code letter	Capacitance tolerance
A	Tolerance to which no other code applies	R	-20%/+30%
K	$\pm 10\%$	S	-20%/+50%
M	$\pm 20\%$	T	-10%/+50%
N	$\pm 30\%$	V	-10%/+100%
Q	-10%/+30%	Y	0%/+50%
		Z	-20%/+80%

The climatic category is specified to IEC 60068-1, refer to chapter "General technical information, 7.4 IEC climatic category" on page 31. If there is not enough space on the case, the following codes may be used:

E.g.: 40/085/56, in coded form, would read GPF

1st letter (lower category temperature)

Code letter	F	G	H
Temperature ( $^{\circ}$ C)	-55	-40	-25

2nd letter (upper category temperature)

Code letter	K	M	P	S	U
Temperature ( $^{\circ}$ C)	+125	+105 (+100)	+85	+70	+60

3rd letter (humidity)

Letter F: withstands test Cab (damp heat, steady state), test duration 56 days, to IEC 60068-2-78.

## General technical information

### 14 Packing

When packing our products, we naturally pay attention to environmental protection aspects. This means that only environmentally compatible materials are used for packing, and the amount of packing is kept to an absolute minimum. In observing these rules, we are also complying with German packing regulations.

- In order to further comply with the aims of the regulations concerning the reduction of waste, we have implemented the following measures:
- The use of standardized "Euro"-pallets.
- Goods are secured on the pallets using straps and edge protectors made of environmentally compatible plastics (PE or PP).
- The shipping cartons (transport packing) qualify for and carry the RESY logo.
- Separating layers between pallets and cartons are of a single material type, preferably paper or cardboard.
- Paper is used as filler and padding material.
- The shipping packaging are sealed with plastic tape to ensure technically efficient recycling.
- By agreement, we are prepared to take back the packing material (especially product-specific plastic packages). However, we ask our customers to send cardboard cartons, corrugated cardboard, paper etc. to recycling or disposal companies in order to avoid unnecessary transportation of empty packing materials.

#### 14.1 Bar code label

The packing of all our components bears a bar code label stating the type, ordering code, quantity, date of manufacture and batch number. This enables a component to be traced back through the production process, together with its batch and test report.

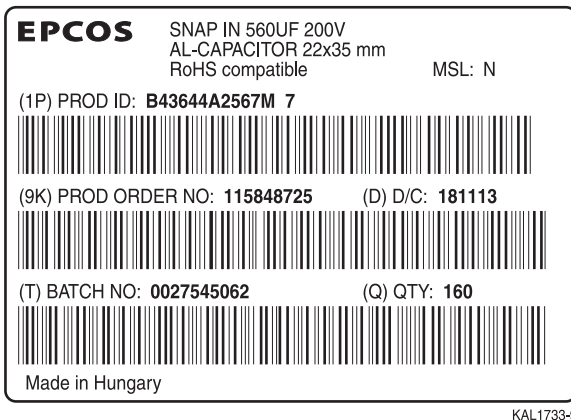

- (1P) Ordering code
- (9K) Product order number
- (D) Date code (yywwdd)
- (T) Batch number
- (Q) Quantity

Figure 26  
Example of bar code label

## General technical information

### 15 Structure of the ordering code (part number)

All technical products made by TDK Electronics are identified by a part number (which is identical to the ordering code). This number is the unique identifier for any respective specific component that can be supplied by us. The customer can speed up and facilitate processing of his order by quoting the part numbers. All components are supplied in accordance with the part numbers ordered.

A part number consist of up to 15 digits and comprises three blocks of data. Each of these blocks starts with a letter, all other positions are allocated to numerals.

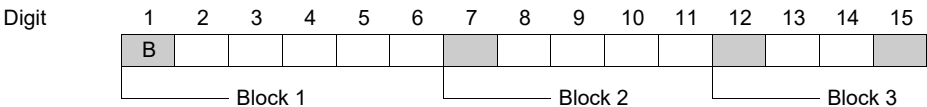

Digit	Meaning																						
1	B = Passive components																						
2	4 = Electrolytic capacitors																						
3	0 = Hybrid polymer capacitors 1 = Low-voltage range $\leq 100$ VDC 2 = Single-ended bipolar capacitors 3 = High-voltage range $> 100$ V DC																						
4 to 6	Type																						
7	Design variant																						
8	Rated voltage <table border="1" style="width: 100%; border-collapse: collapse;"> <thead> <tr> <th style="width: 50%;">Low-voltage range (V DC)</th> <th style="width: 50%;">High-voltage range (V DC)</th> </tr> </thead> <tbody> <tr> <td>1: 3</td> <td>1: 150, 160</td> </tr> <tr> <td>2: 6.3</td> <td>2: 200*), 250</td> </tr> <tr> <td>3: 10, 12</td> <td>3: 300, 385*)</td> </tr> <tr> <td>4: 15, 16</td> <td>4: 350</td> </tr> <tr> <td>5: 25</td> <td>5: 450</td> </tr> <tr> <td>6: 30, 50</td> <td>6: 500</td> </tr> <tr> <td>7: 35, 40</td> <td>7: 510, 520, 550*)</td> </tr> <tr> <td>8: 63, 70</td> <td>8: 330, 600*)</td> </tr> <tr> <td>9: 100</td> <td>9: 360*), 400*)</td> </tr> <tr> <td>0: special</td> <td>0: special</td> </tr> </tbody> </table> <p>*) Designation with code number "0" possible for older types.</p>	Low-voltage range (V DC)	High-voltage range (V DC)	1: 3	1: 150, 160	2: 6.3	2: 200*), 250	3: 10, 12	3: 300, 385*)	4: 15, 16	4: 350	5: 25	5: 450	6: 30, 50	6: 500	7: 35, 40	7: 510, 520, 550*)	8: 63, 70	8: 330, 600*)	9: 100	9: 360*), 400*)	0: special	0: special
Low-voltage range (V DC)	High-voltage range (V DC)																						
1: 3	1: 150, 160																						
2: 6.3	2: 200*), 250																						
3: 10, 12	3: 300, 385*)																						
4: 15, 16	4: 350																						
5: 25	5: 450																						
6: 30, 50	6: 500																						
7: 35, 40	7: 510, 520, 550*)																						
8: 63, 70	8: 330, 600*)																						
9: 100	9: 360*), 400*)																						
0: special	0: special																						
9 to 11	Capacitance The capacitance is given in coded form. Examples: Data digit            9    10    11 B 4 3 6 3 0 A 9 <table border="1" style="display: inline-table; vertical-align: middle;"><tr><td>1</td><td>5</td><td>7</td></tr></table> = $15 \cdot 10^7$ pF = 150 pF	1	5	7																			
1	5	7																					

