



Application Note 2024

Digital Readout of NTC Thermistors

Circuit optimization



www.tdk-electronics.tdk.com

Digital Readout of NTC Thermistors: Circuit Optimization

Introduction

NTC (negative temperature coefficient) thermistors are thermally sensitive semiconductor resistors whose resistance decreases with increasing temperature. With a typical sensitivity of $\alpha = -4\%/K$, the negative temperature coefficient of resistance is about ten times higher than that of metals and about five times higher than that of silicon temperature sensors. The combination of low power consumption, high sensitivity, and signal stability makes NTC thermistors the most popular choice for temperature sensors in automotive battery management, motor and climate control, factory automation, and field instruments.

Our application note [Digital readout and trimming of NTC thermistors](#) explains the basic circuit designs and software considerations for converting the resistance of the NTC into a digital temperature readout. This paper will focus on the hardware side and cover topics such as self-heating, EMI, and signal amplification. The example circuit for this application note consists of an S868 NTC from TDK with individual calibration data, a bias resistor, an ESP32 microcontroller module, an ADS1115 A/D converter (ADC) module, and a 0.96-inch OLED display.

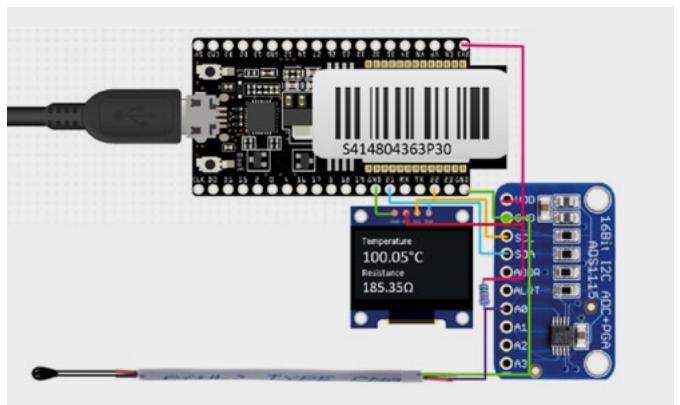
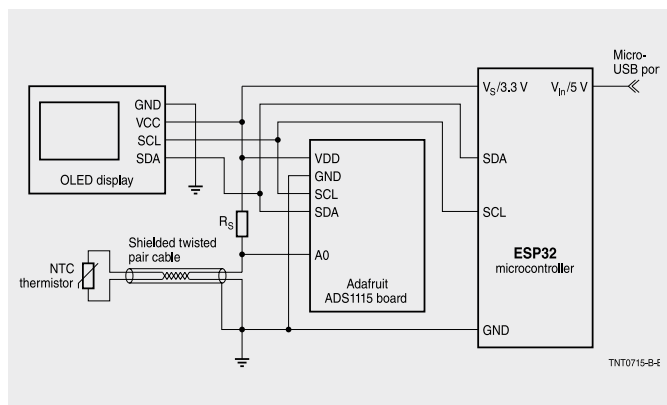

Figure 1: Circuit and wiring diagram of the demonstration hardware

Table of contents

1. Demonstration hardware description	3
2. NTC Thermistor circuit design considerations	3
2.1 Self-heating effects	3
2.2 Using the PGA of ADS1115 to reduce self-heating	4
2.3 Considerations for low voltage measurement	5
2.4 Resistance-to-temperature conversion algorithms	5
3. Estimation of overall system uncertainty	6
4. Summary	7
5. References	8

Digital Readout of NTC Thermistors: Circuit Optimization

1. Demonstration hardware description

The demonstration hardware uses a B57868S0202H NTC thermistor as sensing element. The leads of the NTC thermistor are extended using a shielded twisted pair cable. Due to the shielding and twisting, any electromagnetic interference is eliminated. The hardware further consists of an ESP32 module, an ADS1115 ADC module, and a 0.96-inch OLED display. The ESP32 module has a linear voltage regulator onboard which converts the 5 V input voltage of micro-USB to 3.3 V stable output voltage. This 3.3 V is then applied to the NTC thermistor via a 10 k Ω fixed resistor (resistive voltage divider). The voltage (V_{NTC}) at the middle point of this divider is read by the ADC.

The ADC module from Adafruit contains the ADS1115 analog-to-digital converter from Texas Instruments (TI) and all the necessary passive components. The ADS1115 has a programmable gain amplifier integrated whose gain can be adjusted from (0.75 to 16), enabling it to read ± 6.144 V to as low as ± 0.256 V with 15-bit resolution. The voltage-to-temperature conversion is done in the microcontroller using the Steinhart-Hart software class definition from the [TDK Design Tool pages](#) and applying individual calibration data that can be provided for all the S868 family types to eliminate manufacturing tolerances.

2. NTC Thermistor circuit design considerations

2.1 Self-heating effects

The correct bias resistor is crucial since it significantly impacts the system's overall performance (accuracy and resolution). One common approach is to take the square root of the highest resistance multiplied by the lowest resistance of the NTC thermistor in the desired operation range. Such an approach optimizes sensitivity within the ADC range and works well for thermistors with high nominal resistance but can result in high self-heating for thermistors with low nominal resistance. Let's assume that the lowest and highest temperatures measured are +10 °C and +150 °C. At these temperatures, the resistance of the B57868S0202H is 3797 Ω and 58.45 Ω respectively. Therefore, a typical initial choice of the bias resistor to maximize the sensitivity of the circuit would be:

$$R_s = \sqrt{R_{10} \cdot R_{150}} = \sqrt{3797 \Omega \cdot 58.45 \Omega} \approx 470 \Omega$$

In thermal equilibrium, the electrical power equals the heat dissipation of the NTC while maintaining a small temperature difference ($T_{NTC} - T$) to the environment - this is the self-heating:

$$V_{NTC} \cdot I = \delta_{th} \cdot (T_{NTC} - T) \quad [1]$$

The dissipation factor δ_{th} is defined as the ratio of the change in power dissipation and the resultant change in the thermistor's body temperature. It is expressed in mW/K and serves as a measure of the load that causes a thermistor in steady state to raise its body temperature by 1 K. The higher the dissipation factor, the more heat is dissipated by the thermistor to its surroundings. The dissipation factor of a thermistor therefore depends on its mounting and the medium or environment in which it operates.

With a heat dissipation factor in air of typically 1.7 mW/K, the temperature difference caused by self-heating can be calculated:

$$\Delta T = T_{NTC} - T = \frac{1}{\delta_{th}} \cdot \frac{R_{NTC}}{(R_s + R_{NTC})^2} \cdot V^2$$

The maximum self-heating occurs at $R_{NTC} = R_s$ with a temperature difference of:

$$\Delta T_{max} = V^2/4 \cdot \delta_{th} \cdot R_s \approx 3.4 \text{ K}$$

Figure 2 shows the full self-heating within the temperature range in comparison to the tolerance of the thermistor.

Digital Readout of NTC Thermistors: Circuit Optimization

2. NTC Thermistor circuit design considerations

2.1 Self-heating effects

By the initial choice of R_{NTC} and R_S to maximize sensitivity the self-heating in the given circuit exceeds the tolerance of the NTC. According to industry standards (such as IEC 60751), the error caused by self-heating shall not exceed 25% of the sensor's tolerance specification: the circuit must be improved.

A straightforward fact is that the larger the resistance of the NTC and shunt resistor, the lower the self-heating. In the given case

of a 3.3 V power supply a NTC with $R_{25} = 100 \text{ k}\Omega$ and similar B-value in combination with a 22-k Ω shunt resistor would have limited the self-heating to $\Delta T_{max} = 0.1 \text{ K}$.

In the following, measures to reduce the self-heating are described if neither an increase of NTC resistance nor reducing the supply voltage are viable options.

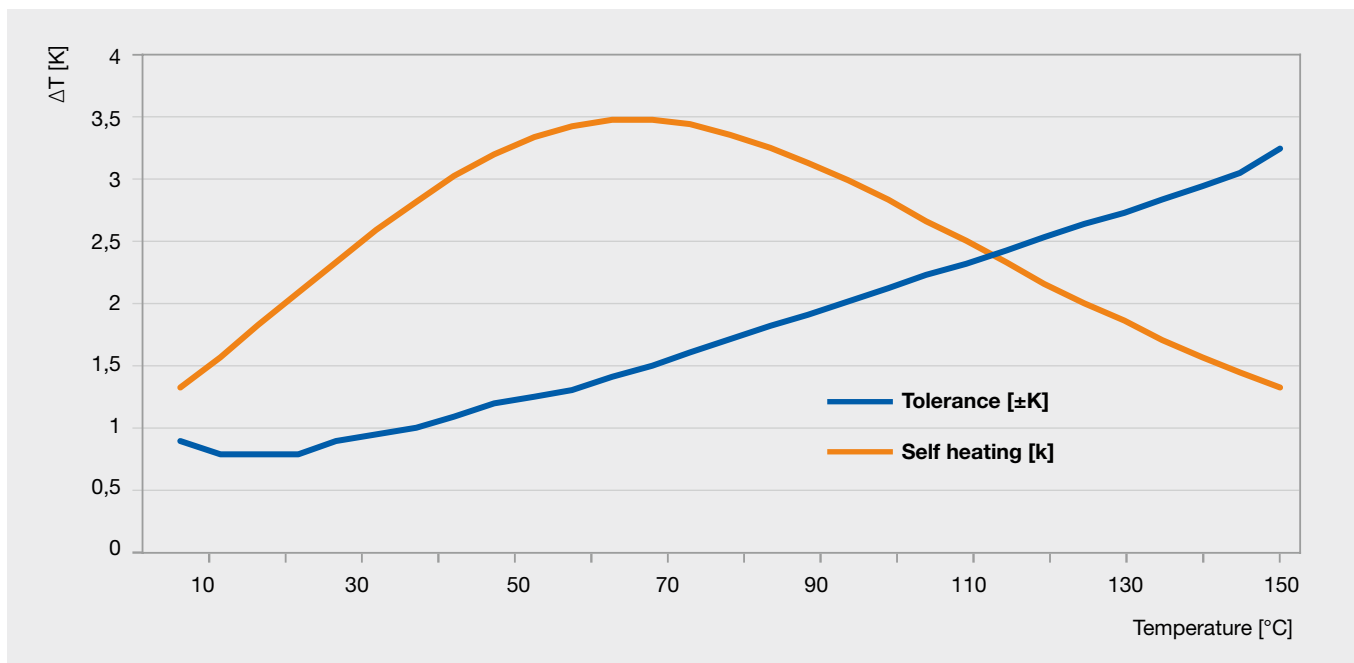

Figure 2: Self-heating of a 2-k Ω NTC thermistor that exceeds nominal tolerance due to a poor choice of the bias resistor

2.2 Using the PGA of ADS1115 to reduce self-heating

The new NTC family B57868S0202H with individual calibration data features a resistance tolerance of 0.3% and a corresponding temperature accuracy of approximately 0.1 K at +100 °C. A typical design target for a high accuracy circuit therefore is a self-heating limit of 25 mK at +100 °C (25% of tolerance according to IEC 60751). With a given NTC and a given microcontroller, only the bias resistor can be varied. Additionally, the temperature resolution r_T of the ADC must be considered to match the desired accuracy range: $r_T < 25 \text{ mK}$.

The self-heating effect with three different shunt resistors ($R_S = 3 \text{ k}\Omega$, $R_S = 5 \text{ k}\Omega$, and $R_S = 10 \text{ k}\Omega$ instead of 0.47 k Ω) is shown in Figure 3. Just increasing the bias resistor also greatly improves the self-heating but at the same time reduces the overall voltage drop at the NTC: Therefore, the programmable gain of the ADS1115 is used to map the limited voltage range on the 16 bits of the ADC output. For a programmable gain amplifier (PGA) gain set of 16 the resolution can be calculated as:

$$\text{LSB} = \frac{0.256 \text{ V}}{32768} = 7.8 \mu\text{V}$$

Digital Readout of NTC Thermistors: Circuit Optimization

2. NTC Thermistor circuit design considerations

2.2 Using the PGA of ADS1115 to reduce self-heating

The resistance and temperature resolution r_R and r_T can be calculated by:

$$r_R = \frac{LSB \cdot R_S}{V_S - LSB} \quad r_T = \frac{1}{\alpha \cdot R_{NTC}} \cdot r_R$$

With R_S and V_S the resistance and voltage drop of the bias resistor, R_{NTC} the actual resistance of the NTC and α the actual relative sensitivity of thermistor. As a function of temperature, R_{NTC} and α can both be found in the datasheet of each NTC.

After considering the self-heating (Figure 3) and system resolution (Figure 4), a 10-k Ω shunt resistor is the best choice. Due to its high resistance, the error due to self-heating is below 7% of the tolerance specification of the sensor.

Remark: Instead of an external high-resolution ADC, a technique known as “Oversampling and Decimation” may be used to achieve higher resolution. Oversampling involves acquiring the input signal at a rate that is significantly higher than the Nyquist frequency of the output. The results are added and right-shifted by a factor of n , producing an output with a n -bit increase in resolution. For details see for example the [application note from Atmel \(Microchip\)](#). [7]

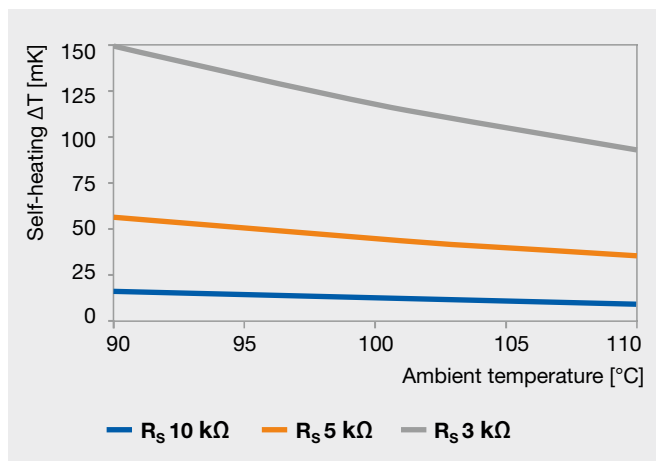

Figure 3: Comparison of self-heating with different shunt resistors

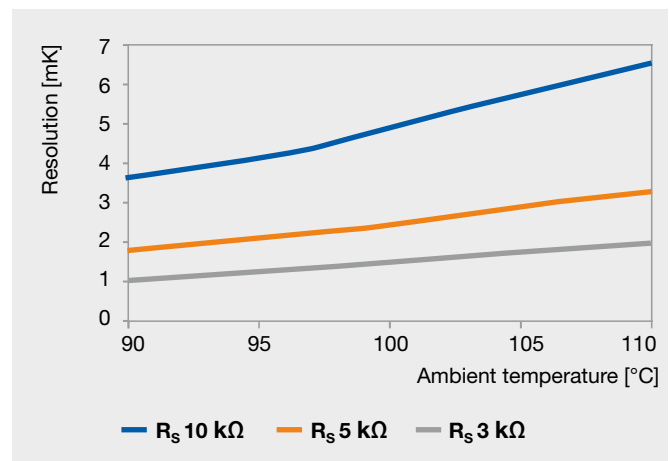

Figure 4: Comparison of temperature measurement resolution with different shunt resistors

2.3 Considerations for low voltage measurement

Low voltages are vulnerable to noise. Therefore, care must be taken to eliminate or reduce the impact of noise in ADC’s reading. In most cases, averaging raw ADC readings is sufficient but increases the response time of the system. If an extension of the sensor leads is required, a shielded twisted pair cable can be used to connect the sensor to the circuit.

This cable must be as short as possible and should have very low specific resistance. As NTCs usually work with high basic resistances the compensation of cable resistance is in most cases not necessary. The ideal operating temperature for the low voltage measurement circuit is (+23 °C ± 5 K). Circuits working above or below this operating temperature may require offset error compensation.

2.4 Resistance-to-temperature conversion algorithms

TDK provides the code library for the NTC thermistor’s resistance-to-temperature conversion. It contains all three algorithms: Look-up table-based calculation, B-value-based calculation, and Steinhart-Hart model-based calculation. For example, the displayed value on the thermometer is

calculated from the Steinhart-Hart model since it is the most accurate conversion method among these three algorithms. More detailed information regarding errors due to the conversion method can be found in an [application note from TDK](#). [8]

Digital Readout of NTC Thermistors: Circuit Optimization

3. Estimation of overall system uncertainty

The accuracy of the entire temperature measurement system may be significantly impacted by the external elements connected to the temperature sensors. The common sources of error in the system are the deviation of the supply voltage (V_S), the tolerance of the shunt resistor (R_S), and the error from the ADC (offset error, gain error, noise, and integral non-linearity). Usually, all error margins are given in the specification of the components. A summary of error margins of the components used here can be found in Table 1.

Name	Symbol	Value @ 100 °C measurement
Supply voltage deviation	u_{V_S}	± 0.02 V
Bias resistor tolerance (incl TCR)	u_{R_S}	± 20 Ω
Total ADC error	$u_{V_{ADC}}$	± 0.06 mV
NTC calibration error	ΔR	± 1.12 Ω

Table 1: Tolerances and error contributions

The resistance of the NTC thermistor (R_{NTC}) is not directly measured but determined from the voltage measurement, the known bias resistor, and the known bias voltage through a functional relationship shown in the following equation:

$$R_{NTC}(V_{NTC}, R_S, V_S) = \frac{V_{NTC} \cdot R_S}{V_S - V_{NTC}}$$

Therefore, the combined uncertainty in resistance measurement of NTC thermistor can be expressed by the following equation. [9]

$$u_{R_{NTC}} = \sqrt{\left(\frac{R_S \cdot V_S}{(V_S - V_{NTC})^2}\right)^2 \cdot u_{V_{ADC}}^2 + \left(\frac{V_{NTC}}{V_S - V_{NTC}}\right)^2 \cdot u_{R_S}^2 + \left(\frac{-V_{NTC} \cdot R_S}{(V_S - V_{NTC})^2}\right)^2 \cdot u_{V_S}^2}$$

Where $u_{V_{ADC}}$ is the total error in ADC readings, u_{R_S} the error coming from the bias resistor, and u_{V_S} the error coming from the bias voltage. Finally, the total resistance measurement uncertainty u_r is the RMS value of the error from the resistance measurement of the NTC thermistor $u_{R(NTC)}$ (Figure 5) and the specified tolerance of NTC thermistor ΔR (Figure 6).

$$u_r = \sqrt{(u_{R(NTC)})^2 + (\Delta R)^2}$$

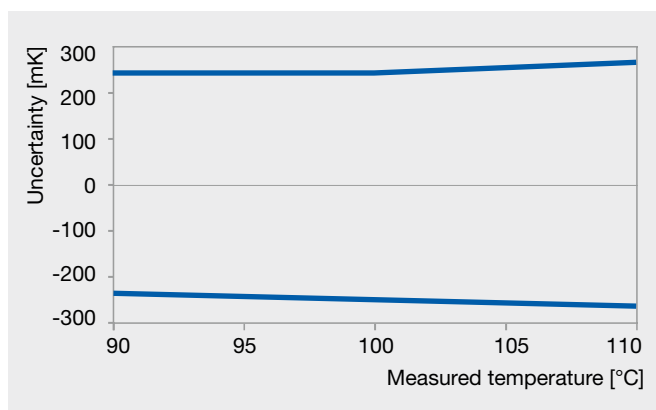

Figure 5: Uncertainty caused by the resistance measurement $u_{R_{NTC}}$

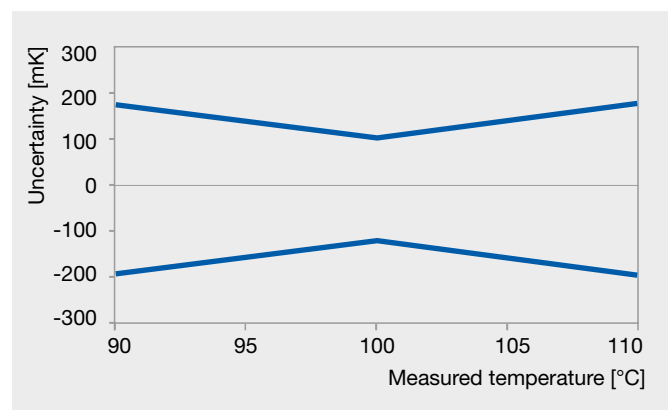

Figure 6: Uncertainty caused by the NTC thermistor's tolerance ΔR

Digital Readout of NTC Thermistors: Circuit Optimization

3. Estimation of overall system uncertainty

Hence the total temperature measurement uncertainty u_T can be expressed by the following equation:

$$u_T = \frac{u_r}{R_{NTC} \cdot \alpha}$$

To calculate the accuracy of the demonstration thermometer, the error margins of the components used are inserted into the above equations. The resulting uncertainty is then plotted over the desired temperature measurement range (see Figure 7).

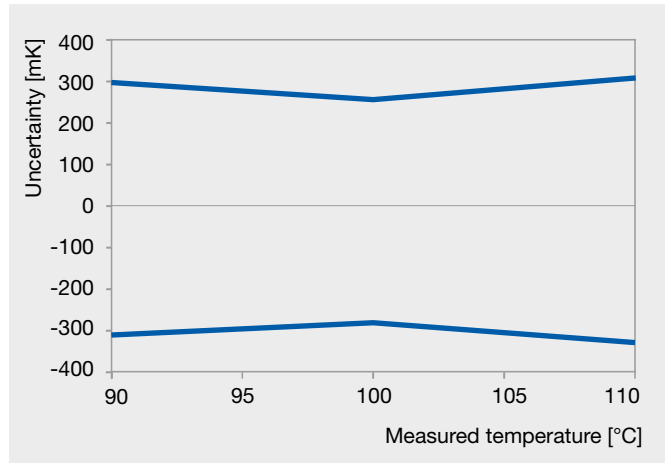

Figure 7: Total uncertainty in temperature measurement of the demonstration thermometers

4. Summary

By using B57868S0202H sensors with individual calibration data, the accuracy of temperature measurement devices can be improved significantly without any physical calibration process. TDK provides all necessary NTC libraries for resistance-to-temperature conversion and software trimming with C++ and Python.

To choose the best bias resistor, the self-heating effect and measurement resolution must be balanced. By implementing

ADC resolution improvement techniques, measurement resolution can be increased in the case of high-bias resistors. By using accurate components in hardware design, it is possible to enhance the accuracy of the temperature measurement. Shielded twisted pair cables can be used to minimize EMI errors caused by long cabling.

References

- [1] **TDK Electronics AG**
[B57868S0202H NTC thermistor data sheet](#)
- [2] **Texas Instruments**
ADS111x ultra-small, low-power, I2C-compatible, 860-SPS, 16-Bit ADCs
With internal reference, oscillator, and programmable comparator <https://www.ti.com/product/ADS1115>, 2018.
- [3] **Adafruit Industries**
Adafruit 4-channel ADC breakouts
<https://learn.adafruit.com>
- [4] **Espressif Systems**
[ESP32 datasheet](#)
- [5] **Tektronix, Inc.**
[Low level measurements handbook 7Ed](#)
- [6] **AZ Delivery**
[0.96 OLED display datasheet](#)
- [7] **Microchip Technology Inc.**
[AVR121: Enhancing ADC resolution by oversampling](#)
- [8] **TDK Electronics AG**
[Digital readout and trimming of NTC thermistors](#)
- [9] **JCGM 100:2008**
Evaluation of measurement data - guide to the expression of uncertainty in measurement

Individual NTC resistance data

TDK provides individual resistance data for all S868 types featured in the [product catalog](#).

Address and contact info

Dr. Bernhard Ostrick
Product Development
Temperature & Pressure Sensors Business Group
bernhard.ostrick@tdk.com
www.tdk-electronics.tdk.com

Important information: Some parts of this publication contain statements about the suitability of our products for certain areas of application. These statements are based on our knowledge of typical requirements that are often placed on our products. We expressly point out that these statements cannot be regarded as binding statements about the suitability of our products for a particular customer application. It is incumbent on the customer to check and decide whether a product is suitable for use in a particular application. This publication is only a brief product survey which may be changed from time to time. Our products are described in detail in our data sheets. The Important notes (www.tdk-electronics.tdk.com/ImportantNotes) and the product-specific Cautions and warnings must be observed. All relevant information is available through our sales offices.