



	Page
Requirements on the manufacture of electrical equipment and systems	110
Systems with residual current devices	116
Renewable energy	121
Application examples	125
Filters and chokes for frequency converters	130
Filters for switch-mode power supplies	143
Interference suppression of equipment	147

1 Requirements on the manufacture of electrical equipment and systems

1.1 Responsibility for the use of EMC filters

Manufacturers of electrical equipment and systems have an obligation to develop and manufacture their products on the basis of state-of-the-art technologies as well as to the applicable standards and laws and to deliver them in a safe condition to the customer. Safety in terms of the Low Voltage Directive (2006/95/EC) applicable in Europe means that the products must be designed and constituted so that human beings and animals are protected from any risk of injury resulting from direct or indirect contact. Non-electrical hazards such as mechanical effects, temperature, arcing and radiation must also be considered.

However, the safety of many products largely depends on how the components are mounted in the end product, and on the total characteristics of the end product. For this reason, components such as inductors and filters have been deliberately excluded from the scope of the Low Voltage Directive.

The manufacturer of products must determine the requirements on the components in each specific application with due care and select them accordingly. In addition to the standard criteria such as rated current, voltage, temperature, environmental conditions and network type, possible short circuit currents and overvoltages occurring in the system must also be considered.

1.2 Importance of safety directives worldwide

Efforts are being made worldwide to harmonize the standards for products and installations. This is increasingly being done in IEC standards by the International Electrotechnical Commission. These standards are in most cases subsumed in regional (e.g. EN = European standards) and national standards, often together with specific comments. The IEC standards stipulate the minimum requirements on the products. The technical details of the implementation in most cases remain the responsibility of the manufacturers.

The procedure on the North American market differs from this. The regional safety system includes the interests of the local authorities, manufacturers, insurance companies and end customers. National legislation takes place via NEC (National Electrical Code), CEC (Canadian Electric Code), NFPA (National Fire Protection Association), as well as via individual supplements by local authorities. Thus the USA requires approval for all electrically controlled equipment and systems. This approval can be carried out by recognized test laboratories such as UL and CSA.

EPCOS has a large number of products with the corresponding approvals. If required, please contact your local sales or marketing department. The reverse-imaged UR mark is a widely used symbol on EMC filters from EPCOS after approval.



Figure 1: Test approval mark issued by the UL test organization to the UL and CSA regulations

Application notes

This reversed-image UR mark applies to components forming part of a product or system. These include EMC filters in frequency converters. Depending on their technical and constructional design, these components may be subject to restrictions and may be installed only by qualified personnel.

1.3 Short circuit currents

1.3.1 Causes and protection options

Ever since power supply systems were first introduced, fault conditions such as inadvertent short circuits were included in the analysis of safety systems. Such short circuits may be due to various causes, such as insulation breakdown or change, but also to human error. Fault-current protection devices, such as fuses and circuit breakers, are widely used to limit the negative impact of this fault case. EPCOS specifies corresponding overcurrent protective devices for the operation of its components. These limit the duration of high short-circuit currents and thus the stresses due to thermal effects and electromagnetic forces.

The calculation of the possible short circuit currents and the resulting selection of suitable components and equipment has been a procedure widely used in European countries for many decades. Thus several parts of IEC 60909 concern short-circuit currents in three-phase networks, and the standard parts of IEC 60865 include calculations of their impact. They aim to protect the system components as far as possible before they are damaged or destroyed in the event of the fault case caused by a short circuit.

1.3.2 Dimensioning and selecting components

An exact calculation of short-circuit currents requires detailed knowledge of the power supply equipment, including the wiring and cable systems. Details may be found in the IEC 60909 standard "Short-circuit currents in three-phase AC systems".

A rough calculation is already possible with a knowledge of the electrical parameters of the supply transformer. The short-circuit current I_k can be determined from the rated power, short-circuit voltage, rated voltage and frequency of the transformer. I_k is the initial short-circuit AC current flowing through a transformer connected to a network with unlimited short-circuit capacity.

However, the conduction path attenuates the short-circuit currents. So the inductive and resistive components of the conduction paths should be included in the calculation to improve its accuracy. The resulting short-circuit current should be taken into account in the selection of the components.

1.3.3 Definition of short circuit currents

The currents occurring at a short circuit are defined in very different ways. Clearly defined terms are thus necessary to ensure effective communications. These definitions may be found in the corresponding standards and are often used preferentially in connection with specific technical sectors (e.g. low-voltage switchgear).

Some important short circuit currents are defined briefly below. Details may be found in the specified standards:

I_{cw} = Rated short-time withstand current

The rated short circuit withstand current is an RMS value of the short circuit current which characterizes the thermal strength of a circuit during a brief stress duration; it is as a rule specified for a duration of 1 s; divergent times must be specified [IEC 60439-1; 4.3].

I_{pk} = Rated peak withstand current

The rated peak withstand current is the peak value of the surge current which characterizes the dynamic strength of a circuit [IEC 60439-1; 4.4].

I_{cc} = Rated conditional short-circuit current

The rated conditional short circuit current is the unperturbed short circuit current which can flow in a circuit downstream of a short circuit protection device for a specific period without sustaining damage [IEC 60439-1; 4.5].

1.3.4 SCCR

The term SCCR originates from North America and stands for Short Circuit Current Rating. It corresponds approximately to the IEC definition of the I_{cw} value.

In North America, machine control systems and industrial control panels must be marked with their SCCR value. It should be noted that this value refers not only to the line-side protection but also to the downstream components. However, the circuits inside switching cabinets are excepted. NEC 2008 article 409 describes the conditions for the short circuit strength marking with reference to UL 508A, SB4.

A distinction is made between:

- The feeder circuit = the circuit upstream of the first overcurrent protective device
- The branch circuit = the circuit from the first overcurrent protective device to the load. As filters are protected with these devices, they are assigned to the "branch circuit".

Application notes

For frequency converters, the North American Directive UL 508C (Power Conversion Equipment) stipulates the following minimum SCCR values:

Output ¹⁾		Three-phase motor current at voltage ²⁾			SCCR ¹⁾
		360 ... 380 V A	440 ... 480 V A	550 ... 600 V A	
hp	kW				kA
15 ... 50	1.1 ... 37.3	3.3 ... 83	3.0 ... 65	2.4 ... 52	5
51 ... 200	39 ... 149	... 320	... 240	... 192	10
201 ... 400	150 ... 298	... 636	... 477	... 382	18
401 ... 600	299 ... 447	... 786 ... ³⁾	... 590 ... ³⁾	... 472 ... ³⁾	30
601 ... 900	448 ... 671	... 1290	... 1060	... 850	42
901 ... 1600	672 ... 1193	... 2300	... 1880	... 1500	85
1601	1194 ...	2301...	1881...	1501 ...	100
					125
					200

1) To UL 508C Table 45.1

2) To UL 508C Table 42.1

3) Motor current specified for 500 hp

Section 39 of the UL 1283 Standard responsible for EMC filters also defines a short circuit test. Accordingly, all filters tested to UL 1283 Edition 5 for short circuit are considered as having been duly tested, although the test current (Available Short-Circuit Current ASCC) differs from the specifications of UL 508C.

In addition, the series of filters manufactured by EPCOS are tested with the short circuit currents required for practical applications with respect to thermal and electromagnetic stress, accompanied by appropriate model calculations and simulations. Detailed information is available upon request via our local sales representatives.

1.4 Overvoltages

1.4.1 Overvoltage protection of electrical equipment

Overvoltages can damage electrical equipment and impair their correct operation. They can be caused by several factors, such as:

- Lightning strikes; lightning current and overvoltage surges
- Induction due to inductive coupling (influence of magnetic fields)
- Influence of capacitive coupling (influence of electric fields)
- Electrostatic charges
- Voltage changes due to switching operations

Application notes

These may result in the following effects:

- Fire
- Destruction of the equipment
- Data loss
- Equipment malfunctions
- Triggering of hazardous operating conditions

When designing, planning and manufacturing electrical equipment, the manufacturer must select the components used so as to ensure that they are suitable for the loads expected in the application and that hazards are avoided.

1.4.2 Overvoltage categories and rated peak voltages

To help manufacturers select components, the IEC 60664-1 standard provides information on the expected stresses, including a specification of the rated peak voltage as a function of the power supply system and the mounting position. The mounting positions are assigned to overvoltage categories depending on the hazard they represent.

Overvoltage category	Description	Examples
IV	At or close to the power supply; before the main distributor (in the current direction)	Electricity meters; overcurrent protective devices; centralized telecontrol signal devices
III	Equipment forming part of a fixed installation for which increased availability is expected	Distribution panels; power switches; distribution cabinets; equipment for industrial use; stationary motors
II	Equipment designed for connection to the fixed installation of a building	Domestic appliances; portable tools
I	Equipment connected to circuits already protected with transient overvoltage limiters	Electrical control equipment with no internal overvoltage protection

Application notes

In the following table, the overvoltage categories are assigned to an expected rated peak voltage corresponding to the power supply system based on IEC 60664-1):

Power supply system		Line-to-ground voltage	Overvoltage category			
Three-phase	One-phase		I	II	III	IV
		Rated peak voltage				
V						
		50	330	500	800	1500
		100	500	800	1500	2500
230/400	120 ... 240	150	800	1500	2500	4000
277/480		300	1500	2500	4000	6000
400/690		600	2500	4000	6000	8000
1000		1000	4000	6000	8000	12000

1.4.3 Overvoltage at EMC filters

With the exception of a few special applications, the EMC filters from EPCOS correspond to the IEC 60939 standard. This specifies the use of suitable EMI suppression capacitors. These capacitors are designed for pulse voltages in the power line and are subject to a pulse test to IEC 60384-14 for their type approval (see the table below; showing only a subset).

Class	Voltage strength	Pulse test ⁴⁾	Remarks
X1	$4.3 \times V_R$	4.0 kV	High pulse applications
X2	$4.3 \times V_R$	2.5 kV	General purpose
Y2	1500 V AC	5.0 kV	Basic or supplementary insulation

4) Applies to $C \leq 1.0 \mu\text{F}$

In many applications, therefore, the series connection of two capacitors assures sufficient dielectric strength for the relevant overvoltage category. Because of different capacitance values, however, very different voltage conditions result at the capacitors, and these need to be examined in each individual case.

For use in industrial equipment with increased stress or where higher reliability is expected, we recommend additional overvoltage protection. For many customer-specific solutions, varistors and gas discharge tubes are integrated into the filter.

Application notes

2 Systems with residual current devices

2.1 Explanation of terms

A residual-current protection switch cuts off the monitored circuit at all poles when a defined difference current is exceeded (with the exception of the protective conductor). The terms RCD (residual current protective device) and RCCB (residual current operated circuit-breaker) are also used here. Precise definitions are given in the group of IEC 61008 standards. Residual current monitors (RCM) are also used, but these have no built-in turn-off unit for the load circuit.

2.2 Principle of residual current devices

These devices make use of the property that the sum of the currents flowing in both directions is zero in an ideal circuit. A summation current converter on the phase and zero lines thus detects the fault currents. An additional winding on the converter is part of the trip circuit and activates the switching mechanism with the contacts when the limit is reached. The diagram below shows the principle involved.

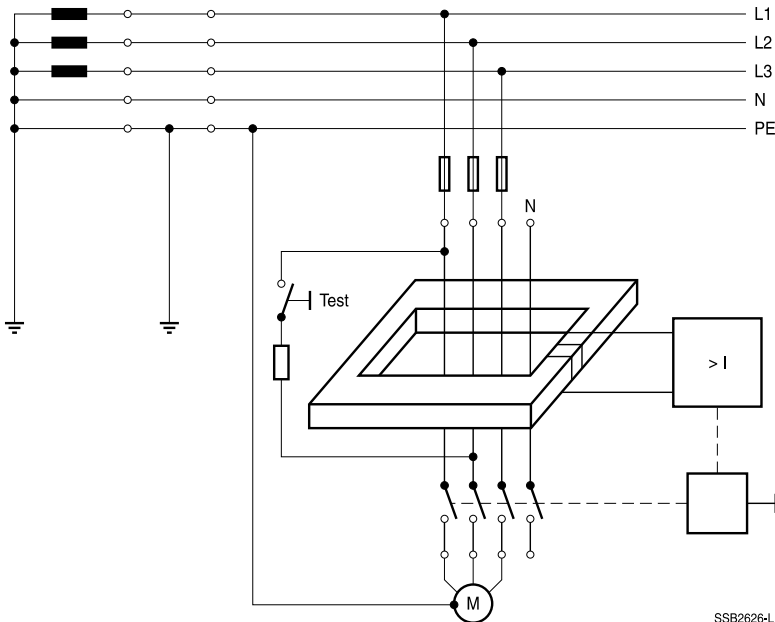

Figure 2 Principle of residual current devices

SSB2626-L

Application notes

2.3 Example of a power drive system

Power drive systems (PDS) are increasingly used to utilize energy efficiently. They can change the engine speed continuously. In principle, an AC voltage is rectified, smoothed in the link circuit and its pulse shape and frequency are converted by electronic switching elements. This is associated with conducted interference, and international standards require the noise levels to be limited, which as a rule requires the use of EMC filters. Figure 3 shows such a drive system in a block diagram.

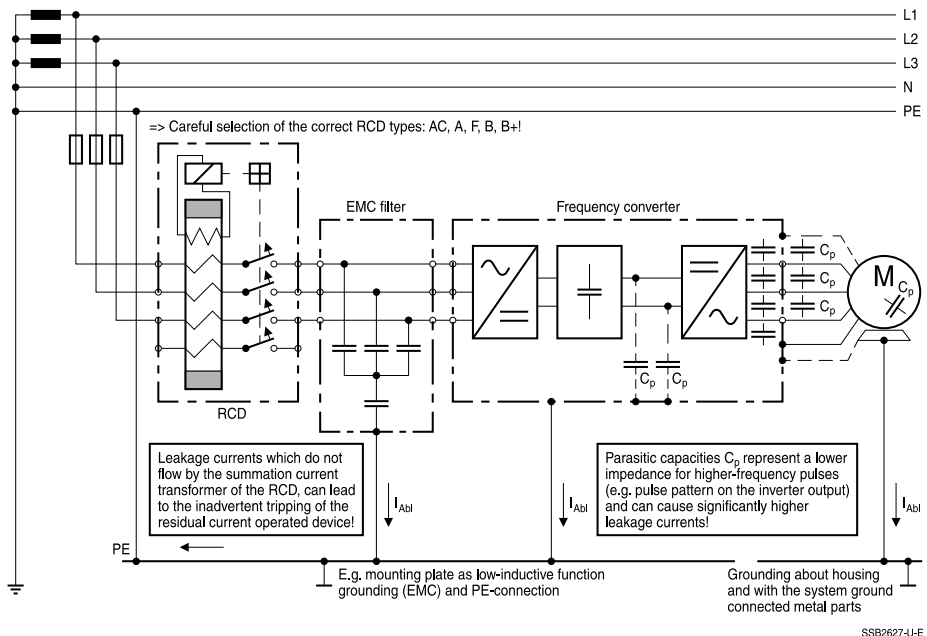

Figure 3 Block diagram of drive system

The block diagram shows that the leakage currents in this drive system are not identical to the specifications in the data sheet for the leakage current of the EMC filter. This specification was standardized in IEC 60939 in 2010 as a calculating method, which however takes into account only the leakage current with respect to the line frequency when the filter is connected to the power supply. To this must be added the leakage currents flowing through additional components such as converters, cables and motors.

Depending on the rectifier circuit, these leakage currents include frequency components as multiples of the line frequency; for example, a three-phase B6 circuit typically produces harmonics of 150 Hz, 450 Hz and 750 Hz. The clock frequencies, which are often in the range of 1 kHz ... 16 kHz, cause significantly higher frequency leakage currents, especially in the cable and motor capacitances.

2.4 Distinguishing residual currents

Residual currents are the sum of the conductor currents (3 phases + neutral). Depending on the cause, a distinction is made between leakage current, protective conductor current, touch current and fault current.

- Leakage current: The largest share of these usually comes from the interference currents generated by the operational clock frequency. They are stimulated by the switching pulses of the IGBT pulse pattern and take the current path via the parasitic capacitances of the cables and motors. The line frequency component of the leakage currents is caused by the rectification and the EMI suppression capacitors on the line side.
- Protective conductor current: The current through the protective conductor must be limited for safety reasons. The limits are specified in standards such as IEC 61140 depending on whether the equipment in question is permanently fixed or movable.
- Fault current: A fault current flows in the event of a low-resistance connection between the voltage-carrying parts and ground. It may be caused by soiling, moisture or defective insulation. A distinction should be made between a fault case on the line and converter sides.
- Touch current: A touch current flows through a person who touches the casing in the event of an interrupted PE connection. A typical limit value is 3.5 mA. If this value is exceeded, suitable measures must be taken, e.g. a protection conductor cross section of at least 10 mm² Cu for permanently fixed equipment. The touch current is also a fault current, whereas the leakage current is not.

2.5 Objectives of residual current devices

The use of residual-current devices has two main aims: to reduce the risk potential of electric shocks, and to prevent fires.

The protection against electric shocks as a rule consists of a combination of two protection modes. The basic protection (against direct contact) prevents people touching live parts, e.g. via insulation. The fault protection (additional protection against indirect contact) aims to prevent a voltage being applied within a defined time in the event of a fault, e.g. by turning off the supply voltage.

The limits for the maximum permissible current come from the specifications of IEC TS 60479 "Effects of current on human beings and livestock": they give various current strengths as a function of the frequency, all of which provide an identical protection level. This differentiation allows "intelligent" residual current devices to be developed. A distinction is typically made between three ranges:

- 0.1 Hz ... 100 Hz with a 30 mA limit
- 100 Hz ... 1000 Hz with a limit increasing from 30 mA ... 300 mA
- 1 kHz ... 100 kHz with a 300 mA limit

Various specifications give a limit of 300 mA in order to prevent fires. This limit also allows systems with clock frequencies in the kHz range to be protected by residual-current protection switches.

Application notes

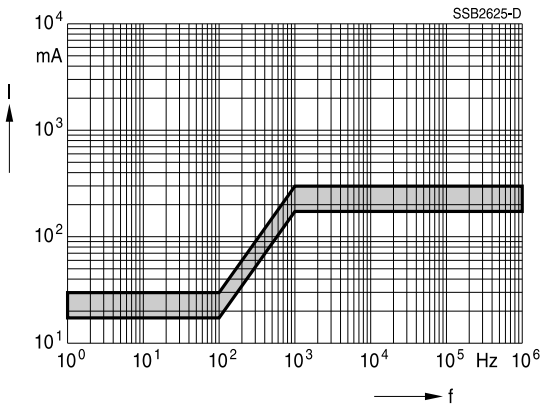

Figure 4 Example: RCCB tripping characteristic

2.6 Types of residual current devices

- Type AC = Alternating current sensitive: Detects only sinusoidal AC fault currents!
NOTE! Not approved for residual-current protection in some countries!
- Type A = Pulse current sensitive:
Detects sinusoidal AC fault currents + pulsating DC fault currents.
Application: Single-phase rectifiers and thyristor controllers.
- Type B = Universal current sensitive:
Residual currents like Type A + smooth DC residual currents.
Application: Multiphase systems and rectifier circuits.
- Type B+ = Universal current sensitive: Properties of Type B + tripping conditions to 20 kHz
- Brief delay types: Turn-off slightly delayed (ca. 10 ms).
Application: For brief pulse currents in normal operation.
- Selective types /S/: Defined turn-off delay.
Application: Series circuit of several protection devices to ensure selective turn-off sequence.

2.7 Suggested solutions in practice

As it can be difficult to distinguish fault currents from operation-caused leakage currents, the protection device can trigger erroneously, thus reducing the equipment availability or the risk of failure.

Suggested solutions:

- Measure the leakage currents in the system; by identifying the cause, the selection of measures to be taken is simplified. Use suitable measurement devices for this purpose. The upper limit frequency of the measuring device should be dimensioned sufficiently for any expected significant components of the leakage current.

Application notes

- Select a suitable type of residual current device for your application.
- Switching operations in multiphase systems can be subject to staggered switching due to mechanical contacts and thus cause line transients. In such cases, use residual current devices with brief delay times.
- Check the best choice of EMC filter with your EMC experts. Note that filters with low leakage currents for the same attenuation properties have a more complex design and are as a rule more expensive.
- Compare the technical data of the motor leads used, especially with respect to the capacitances. Less expensive cables with high capacitance ratings may have to be compensated by expensive measures.
- An optimal switching frequency should be selected at the converter as far as possible.
- Inductors at the converter output (output chokes and output filters) can reduce the leakage current; the EPCOS *SineFormer* filter series B84143V*R127 in particular has proved its worth many times in practice. Please refer to the special requirements of your application, e.g. with respect to the motor dynamics.
- Avoid unnecessary motor lead lengths. Run the motor lead shielding along a large area and on both sides to the converter and motor ground connections.
- Use a separate residual current device for each converter.
- Minimize inrush currents by suitable means (inrush current limiters).

3 Renewable energy

Access to energy is indispensable for national economies to flourish. Stocks of fossil fuels are continuously being depleted. At the same time, an awareness of the need to protect the environment is growing almost everywhere. Strategies are gradually being developed to reduce greenhouse gases and to halt global warming, and many of them are already being implemented in practice. The periodic availability of some renewable energies is making energy storage systems and the intelligent consumption of energy increasingly important. Here too, EPCOS has contributed to various projects and offered suitable solutions. As a company, we assume social responsibility and are committed to environmental protection.

3.1 Energy types

Hydro power

Hydro-electric power is generally recognized as being particularly ecological. Nevertheless, the construction of new systems usually involves major interventions in nature and the landscape. In Germany, the share of hydro-electric power has stagnated in the last decade and has even slightly declined.

Wind energy

Wind is the mode of energy generation that has reached the highest growth rate in Germany and makes up the highest percentage of renewables in the total energy mix. In order to balance out the strong fluctuations in wind speeds, many new and more efficient solutions have been developed in the last decade.



Photovoltaic systems

Thanks to promotion programs in many European countries, the efficiency of solar generators and of the solar converters has been significantly improved. Roofs and open areas are widely used to generate photovoltaic energy.

Application notes

Alternative forms of energy

Other energy sources include biomass; we are already seeing a combination of the elimination of biological waste with the generation of electricity with high efficiency. Starting with the control units, this sector also offers broad scope for EMC suppression components. The list can be further extended, but the share of other systems is significantly lower. In future, new technical solutions will continuously come onto the market in this sector. Fuel cell inverters are just one example.

3.2 Example of photovoltaic applications

The EPCOS manufacturing program offers numerous standard EMC filters for the increasing numbers of photovoltaic applications. But the growing numbers of solar inverters also require many customer-specific solutions, which are efficient parts of the overall concept. Their development began in domestic installations in the range from 1kW ... 5 kW, continued via mid-sized installations of several tens of kW to central inverters feeding into the medium-voltage network in the range of several megawatts.

As in all systems, the product standards must also be observed by the system as a whole. However, there are currently still no EMC product or product family standards for photovoltaic inverters; the general basic technical standards must consequently be applied.

	Residential, commercial and light-industrial environ.	Industrial environments
Emission	EN 61000-6-3	EN 61000-6-4
Immunity	EN 61000-6-1	EN 61000-6-2

Requirements on the AC side with respect to noise voltage limits are thus clearly defined for installations connected to the power line. In contrast, the definition of the limits on the DC side is still at the draft stage of the standard. The basic technical standard for interference emissions in residential areas (EN 61000-6-3) stipulates the measurement of the interference emissions at DC terminals under specific conditions. The edition of this standard from 2007 specifies AC network simulations (impedance 50 Ohm || 50 μ H) for the test set-up, whose large ground capacitances can cause problems for equipment without transformers.

The often long cables leading to the solar panels act as aerials, so that emitted interference fields can perturb other systems, such as radio. Many responsible manufacturers of solar inverters are thus already observing low interference limits in order to avoid perturbing adjacent systems. DC filters from EPCOS not only help to efficiently reduce the interference emissions from extensive cable structures to photovoltaic panels, but also reduce RF interference and leakage currents. They consequently help to increase the operating life of the PV modules.

Application notes

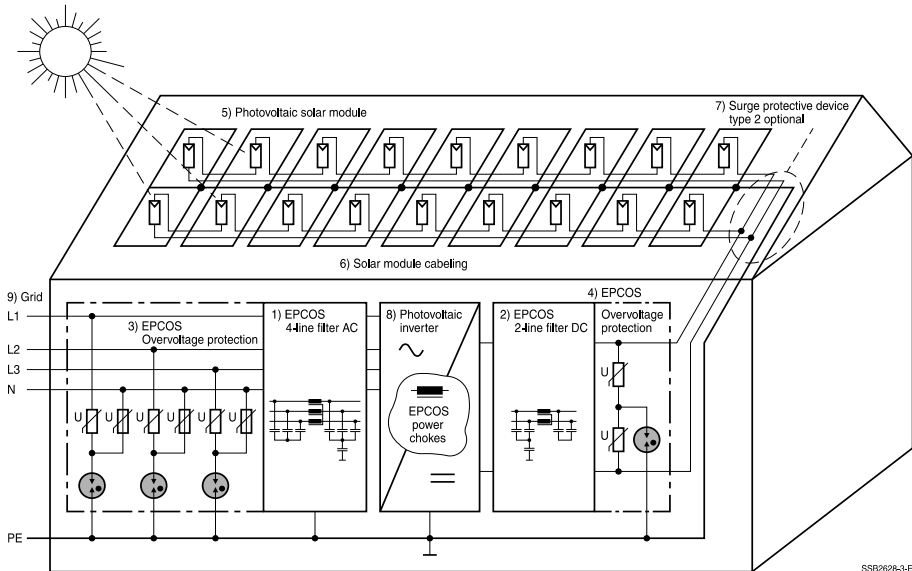

SSB2628-3-E

Figure 5 Example of a photovoltaic system

Components of the photovoltaic application from Figure :

- 1) EPCOS 4-line AC filter
- 2) EPCOS 2-line DC filter
- 3) EPCOS AC overvoltage protection (optionally integrated in filter)
- 4) EPCOS DC overvoltage protection (optionally integrated in filter)
- 5) Solar generator (solar module)
- 6) Solar cabling
- 7) SPD (Surge protective device; Surge arresters) type 2 optional
- 8) Solar inverter with EPCOS power inductors and transformers
- 9) Power distribution system (typical public power grid)

Operators of photovoltaic systems often secure their investments by insuring against plant failure. An increased system reliability is thus expected on the basis of the interplay of all the components involved. Filters with integrated overvoltage protection are also used in such cases. These requirements on higher system reliability are satisfied thanks to the use of high-quality components in filter manufacture in combination with decades of experience in the fields of EMC and overvoltage protection as well as a careful manufacturing process. EPCOS makes expected reliability values available upon request.

However, EMC protection aims and system reliability can be achieved only with the correct interplay of all the components involved. Thus the cables used to connect solar modules should be as short as possible and should take up as little space as possible. Induced currents can be minimized by avoiding extensive cable loops and running the cables along low-inductance paths.

Application notes

Closed grid-shaped racks for photovoltaic modules connected with compensated cables may be used in some cases.

The cost-effectiveness of solar installations is significantly affected by the overall efficiency of the system. In this case too, suitably designed filters and inductors can contribute to minimizing power losses. The low additional costs are over-compensated by the resulting savings in operating life. In accordance with our guidelines for ecological product design, green customer preferences are taken into account, the environmental impacts over the whole product life are estimated and the development aims are derived from them.

In addition to an extensive range of standard components, EPCOS offers customer-specific filters and chokes adapted to specific applications. Please contact your EPCOS sales partner for more details on this point.

4 Application examples

4.1 Industrial applications

EMC filters from EPCOS are manufactured with high quality standards by selecting components and materials of high quality. They are designed in agreement with the applicable standards for continuous operation under the specified extreme conditions. This ensures that the filters satisfy the expectations on their operating life under industrial conditions.



The drives in the rolling mill shown in the photo are an example where it is not only vital to observe the relevant standards, but also to include safety aspects. Electronic systems control large drive systems whose malfunction would release powerful forces and thus represent a considerable hazard potential. As in many other applications, electromagnetic compatibility is also a question of protecting the workforce.

To improve the control of the technological parameters, drives with variable speed control are increasingly used in industry. New components such as innovative IGBTs are extending the outputs of converter drives into the megawatt range. In addition to the technological advantages of such variable speeds, they also bring significant energy savings and thus ecological benefits. The savings are often so great that new investments become profitable after only a few years of use.

Many industrial and artisan companies make exclusive use of installations and equipment certified to observe the EMC limits with respect to interference emissions and noise immunity. This assures the functionality of the machines and significantly increases reliability. Although it may be more expensive at the investment stage, it pays for itself in the long run.

4.2 Filters for regenerative converters (AFE = Active Front End)



In contrast to conventional types, regenerative converters use semiconductor switches (e.g. IGBTs⁵⁾) instead of the otherwise usual diode bridges as rectifiers. These switches can be switched on and off at any time. Suitable control reduces the amplitude of the harmonics generated, so that the current reaching the converters is approximately sinusoidal. A further advantage is that the DC link voltage can be varied up to the peak value of the line voltage. In addition, many regenerative converters can recover energy from the link circuit and feed it back to the power system, e.g. when braking a motor.

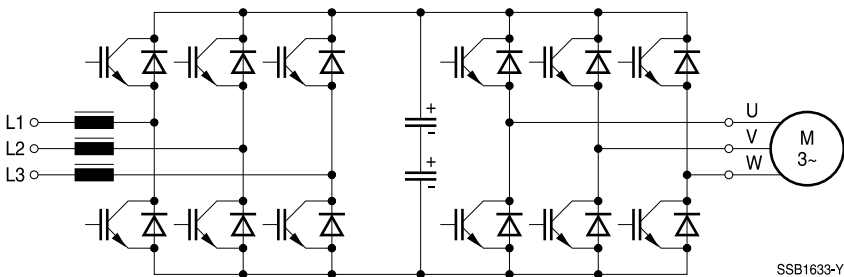

Figure 6 Block diagram of a regenerative converter

However, the clock frequency of the semiconductor switch on the line side of the frequency converter perturbs the circuit. A considerable voltage ripple occurs between the phases. In addition, asymmetrical currents, whose magnitude depends on the total length of the motor lead, flow between the converters and the power line. These effects are reinforced in regenerative operation.

The use of suitable filters and chokes from EPCOS attenuates this interference so far that any perturbation between the converters and adjacent equipment is excluded. The interference voltage limits are reliably observed. For special requirements such as maximum permissible asymmetrical or leakage currents, EPCOS has developed solutions for which patents have already been registered.

5) IGBT = Insulated Gate Bipolar Transistor

4.3 Transport applications



Traction applications such as streetcars, trolleybuses, electric locomotives and modern railcars often have requirements which diverge considerably from those of many industrial applications. These divergences concern both the electrical parameters and environmental requirements with respect to shock, vibration, mechanical strength, pollution and dew formation.

EMC filters from EPCOS are offered as standard filters for many applications, such as input filters for voltages to 1500 V DC and currents to 1600 A. In addition, numerous special types outside the Data Book range are available. If required, we can develop a suitably adapted solution together with the customer.



New developments in motors with low power loading and thus large volumetric efficiency as well as new technologies for converters have now become standard for many marine applications. Thus diesel-electric drives are a comfort feature of large passenger ships and have become indispensable to meet the high requirements on maneuverability, for instance in drilling vessels.

State-of-the-art solutions allow the efficiency at partial load to be significantly improved, a uniform power output to be achieved independently of the continuously regulated engine speed, as well as a fast change of direction for thrust reversal, to name just a few examples.

Application notes

For shipboard power supply systems, the conditions for IT networks apply in many cases, so that the EMC filters used for IT networks should suffice. However, EPCOS also offers solutions for applications with extreme low leakage currents. These are required in some marine applications to ensure greater protection for human beings due to the ship's metallic hull.

4.4 Customer-specific solutions - example: telecommunications

Complex installations often require additional functions to be integrated apart from the EMC filter functions. For customer-specific solutions, for example in the telecommunications sector, the following additional functions are within the scope of delivery from EPCOS:

- Special connectors for AC and DC power supply units with various voltage levels
- Switches (main power switches; function switches)
- Overvoltage protection (integrated solutions; overvoltage protection modules, replaceable)
- Overload protection (fuses; circuit breakers)
- Displays; measurement and monitoring modules
- Electrical interfaces of various types (clamps, pins, leads)
- Data interfaces (e.g. LAN with RJ45 connectors)
- Temperature monitoring systems

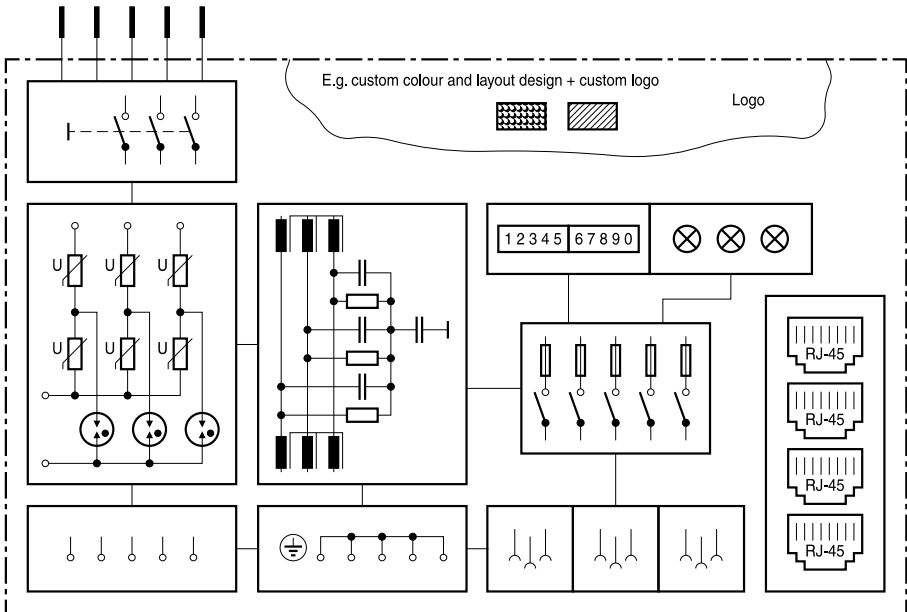

SSB2629-B-E

Figure 7 Block diagram of a telecommunications module

Application notes

Please also refer to the notes on "Services and EMC laboratory" in Section 3 "Customer-specific filters and chokes" on page 151.



Figure 8 Telecommunications module

5 Chokes and output filters for frequency converters



Frequency converters with IGBT⁶⁾ are used increasingly in industry, as they produce outstanding and rugged drive systems together with three-phase asynchronous motors. EPCOS offers a complete range of frequency converter solutions in both standard and customer-specific versions. These include:

- EMC power filters
- Line chokes (commutation reactors) for standard converters with DC inputs
- Filter chokes for regenerative converters
- DC link circuit chokes
- dv/dt chokes
- dv/dt filters (upon request)
- Sine-wave filters
- EMC sine-wave filters (*SineFormer*)

6) Insulated Gate Bipolar Transistor

A complete set of frequency converter solutions

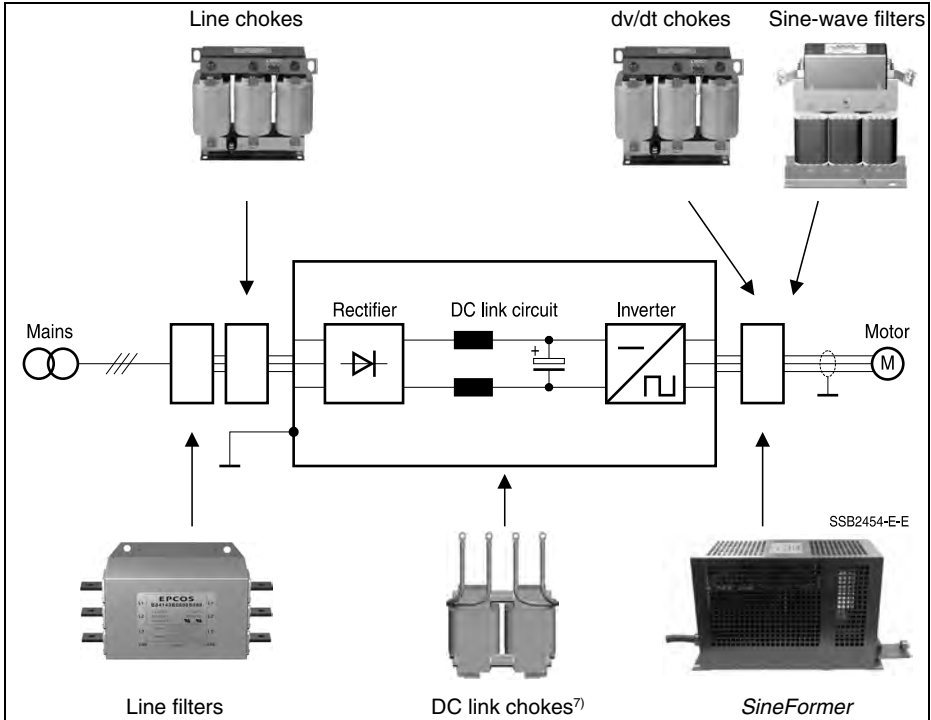

Figure 9 Block diagram of a frequency converter with a commutation reactor, an input filter as well as an output filter or choke

From a constant input voltage and frequency, a converter generates an output voltage whose amplitude and frequency can be modified across a wide range. This is done by rectifying the input voltage and smoothing it in a link circuit. This link circuit voltage supplies a semiconductor bridge circuit. The on time of the semiconductor is regulated by the converter so that a sinusoidal current flows in conjunction with inductive loads (pulse width modulation PWM). Small short circuits are produced on the input side of the frequency converter during the commutation of the rectifying semiconductors, and these give rise to voltage dips on the power side. This system perturbation can be reduced by a commutation choke on the input side of the frequency converter.

The control of the individual half-bridges is staggered on the output side so that a three-phase AC voltage is obtained at the converter output.

7) On request, application-optimized.

Application notes

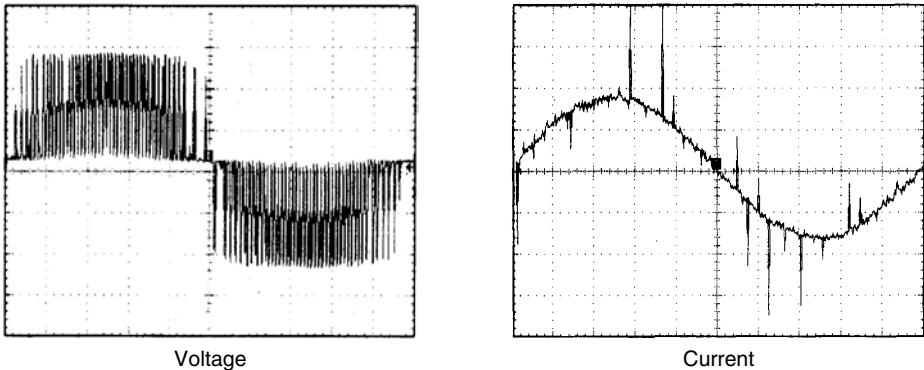

Figure 10 Conductor voltage and current on the converter output without a filter

If the converter and motor are combined in a single unit, this is the best configuration with respect to EMC. In most cases, however, they are connected by a longer lead.

The line has parasitic capacitances between the conductors and with respect to ground. As the rise time of the square wave pulses of the converter output voltage is in the region of 5 to 10 kV/ μ s, higher frequency currents flow in the lead at every switching operation. For long leads, these can become large enough to trigger the surge current protection circuit of the converter. However, they always reduce the current available to the motor. Accordingly, the converter must be dimensioned for a higher rating. In addition, these currents with their high switching frequency content cause losses in the lead and motor.

As part of the higher-frequency currents flow to ground, they produce asymmetrical interference. The use of unshielded motor leads would cause the generation of impermissibly high interference fields. Shielded motor leads must consequently be used, or else sine-wave EMC filters of the *SineFormer* series B84143V*R127/R290 are connected at the converter output.

The high edge steepness of the converter voltage stimulates parasitic oscillating circuits consisting of cable and motor capacitances as well as line inductances, whose decay processes are superposed onto the converter voltage.

Application notes

This leads to brief voltage spikes, especially on the motor side, which can greatly exceed the rated motor voltage (Figure 11). These spikes stress the motor insulation due to partial discharges and lead to premature failure, especially of older motors.

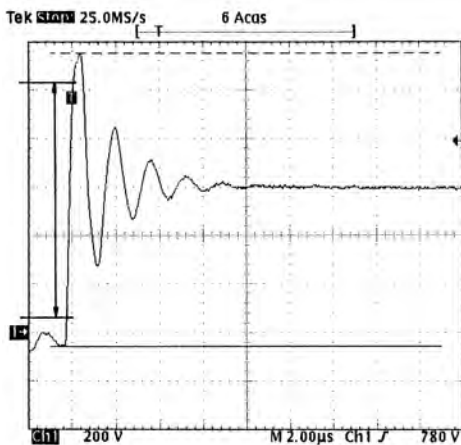

$$\frac{dv}{dt} = \frac{1}{0.136} \frac{kV}{\mu s} = 7.35 \frac{kV}{\mu s}$$

Figure 11 Voltage spikes through a lead

The following effects occur in converter operation:

- High RF reactive currents in the motor lead
- Overvoltages at the motor due to the high voltage steepness and long motor lead
- Bearing damage caused by leakage currents flowing through the motor bearings
- Motor noise
- EMC problems
- Damage to the motor insulation

To reduce these effects, four solutions are applied depending on the nature of the problem:

1. dv/dt chokes
2. dv/dt filters
3. Sine-wave filters
4. EMC sine-wave filters

Note for users:

Converters must be parameterized for operation with output chokes or filters, as they can be stimulated to produce natural oscillations under specific operating conditions. The filters presented in this Data Book have been tested on various converters. They represent only a few examples. Additional filters are available upon request.

Application notes

5.1 Line reactors/commutation reactors

A commutation reactor is a longitudinal choke with a typical u_k value⁸⁾ of 1% ... 5% located in the supply path of the frequency converter. The total line current flows through it. It is available in two versions:

Converters with a diode rectifier circuit:

- In this case, its inductance counters the voltage dips occurring at the time of commutation.
- Converters which can return energy to the supply network:
 - Inrush current limitation
 - Reduction of harmonics

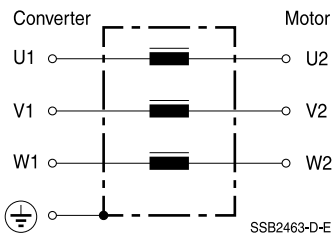

Figure 12

Circuit diagram of a commutation reactor

5.2 Output chokes / dv/dt chokes

A dv/dt choke is a longitudinal choke on the motor side of the frequency converter. The total motor current flows through it. Steep voltage and current edges are somewhat flattened by the inductance. The parasitic capacitances of the connected cable are less strongly charged and discharged. This choke has practically no effect on the phase-to-ground voltage.

The leakage current and the radiated interference are not reduced.

- As a rule, motor leads of up to 50 m are possible
- The motor lead must be shielded
- Almost no improvement in EMC interference

Data sheets on dv/dt chokes may be found on page 475.

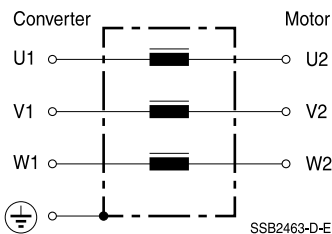

Figure 13

Circuit diagram of a dv/dt choke

8) Magnitude of the voltage drop across the choke in percent referred to the applied phase voltage

Application notes

5.3 dv/dt filters

A dv/dt filter consists essentially of an LC low-pass filter whose limit frequency is greater than the clock frequency of the converters (block diagram, Figure 14).

The filter increases the rise time of the voltage pulses on the line, the voltage spikes at the motor are reduced, and the dv/dt of the output voltage drops.

The effect of this filter is limited to the voltage steepness between the conductors. It has practically no effect on the protection conductor. It does not reduce the leakage current or the radiated interference.

- Motor leads of up to 100 m length are typically possible
- The motor lead must be shielded
- The EMC interference is hardly improved

As a rule, dv/dt filters must be matched to the converters or the application. EPCOS offers customer-specific solutions upon request.

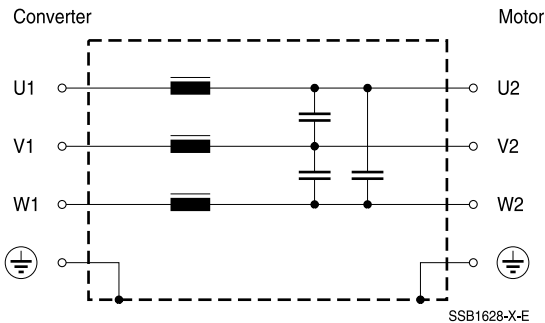

Figure 14 Block diagram of a dv/dt filter and a sine-wave filter

5.4 Sine-wave filters

A sine-wave filter has the same basic circuit as a dv/dt filter (Figure 14), with the difference that the limit frequency is placed between the output and converter clock frequencies. This increases the values of the inductors and capacitors, but also makes the filter more powerful. The share of the switching frequency in the phase-to-phase voltage disappears almost completely (Figure 15).

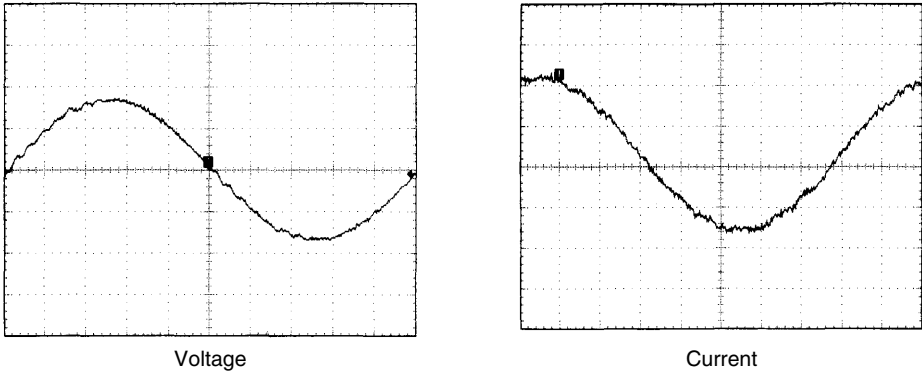

Figure 15 Phase-to-phase voltage and current after a sine-wave filter

As the sine-wave filter mainly affects the symmetrical interference between the lines, the interference acting on the phase-to-ground voltage is hardly reduced at all (Figure 16).

- Motor leads longer than 100 m are possible
- The motor leads must be shielded
- The motor noise and eddy current losses are reduced
- The filter expenditure on the line side may be reduced

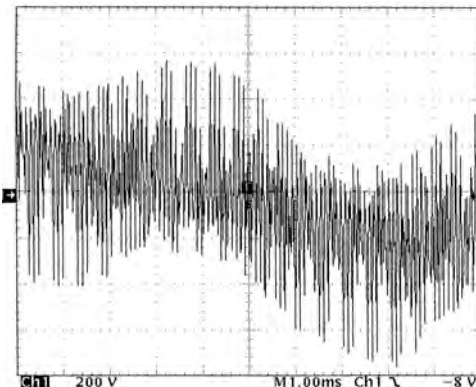

Figure 16 Phase-to-ground voltage after the sine-wave filter

For data sheets for sine-wave filters, see the Section on "Line reactors, output chokes and output filters".

5.5 EMC sine-wave filter *SineFormer*

In order to reduce the asymmetrical interference on the motor lead sufficiently and to dispense shielded motor leads, an EMC sine-wave filter must be used. It is then complemented by a current-compensated choke with capacitors with respect to ground.

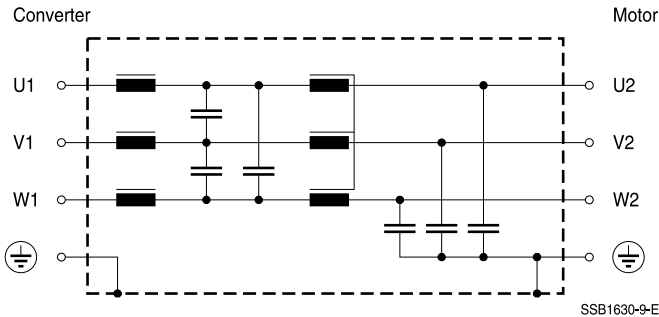

Figure 17
Block diagram of the
EMC sine-wave filter
SineFormer

For further technical data on the *SineFormer* filters, see data sheets B84143V*R127 and B84143V*R290.

Technical benefits of the EMC concept with *SineFormer*:

- Reduction of the dv/dt to $<500 \text{ V}/\mu\text{s}$
- Reduction of the motor noise
- Significant reduction of eddy current losses
- Significant reduction of motor bearing currents
- Preventing interference coupling from the motor lead to other power and signal lines
- Radio interference emissions from the motor line remain within the standard limits
- Optimal reduction of interference (conducted and radiated) compared to other output filters
- No feedback to the converter link circuit needed

Cost benefits of the EMC concept with *SineFormer*:

- Unshielded motor leads can be used, thus reducing the mounting cost, extending the operating life and reducing cable costs
- A smaller motor can be used
- The operating life of the motor can be significantly extended
- Longer motor leads can be used (up to 1000 m for unshielded measurements)
- No maintenance cost, as the *SineFormer* dispenses with forced cooling
- Compact filter (no modular system), hence lower volume and weight
- Reduced requirements on line filters
- Higher system availability
- Also suitable for retrofitting

SineFormer ensures optimal interference suppression and reduces system costs

The possibility to dispense with shielded leads is a particular advantage, as depending on the cross-section and length of the lead, the use of a *SineFormer* is more cost-effective than using shielded leads. The filter cost is in many cases already compensated from a lead length of about 100 m with the use of an unshielded cable. A simple cost comparison of the *SineFormer* and the unshielded leads with that of a sine-wave filter and shielded leads shows that break-even can already be reached for leads shorter than 50 m, excluding the higher mounting cost of the shielded leads.

Figure 18 shows the line-side interference voltage measurement at a frequency converter with an EMC power filter and 100 m unshielded motor lead without an output filter. (The measurement results depend on the mounting of the motor lead, referred to the limits according to EN 55011 Class A/Group 1 or EN 61800-3 Category C2.)

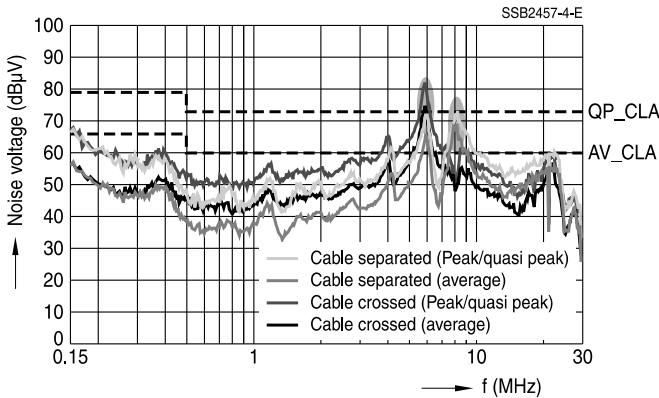

Figure 18
Disturbance voltage test
with unshielded leads

Application notes

A comparison of Figure 19 and Figure 18 is an impressive proof of the superior *SineFormer* technology operating mode. The limits (here to EN 55011, Class A/Group 1 or EN 61800-3 Category C2) are safely observed even if the power line crosses the unshielded motor lead or they run in parallel for 80 cm as specified by EN 61800-3. The optimal efficiency of this new filter technology is shown unequivocally by the fact that essentially no coupling occurs. The use of *SineFormer* filters can mean a final goodbye to the use of shielded leads. System costs can consequently be reduced and the system availability increased.

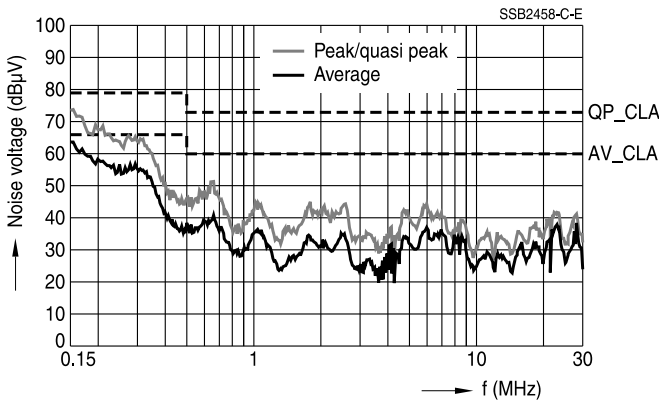

Figure 19
Disturbance voltage test on *SineFormer*
Despite the unshielded cable, the permissible limits are observed.

Common-mode interference generates bearing currents in the motor due to parasitic capacitances. These bearing currents can significantly reduce the operating life of the motor. The *SineFormer* technology suppresses this interference and thus minimizes the bearing currents in the motor, hence extending the motor life in an optimal way.

Figure 20 shows typical values measured at the output of a frequency converter in the time and frequency ranges. The high asymmetrical currents, measured here as bearing currents, are clearly apparent.

Application notes

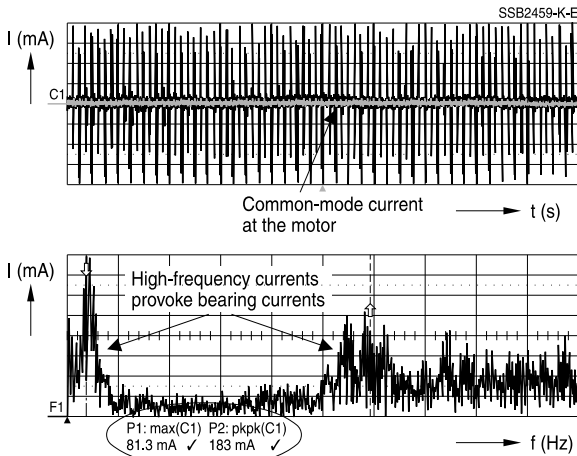

Figure 20
Bearing currents without an output filter

Figure 21 shows the asymmetrical currents flowing with the use of a sine-wave filter. The bearing currents are only partially reduced and cannot contribute to any significant increase in the motor's operating life. Compare this with Figure 20.

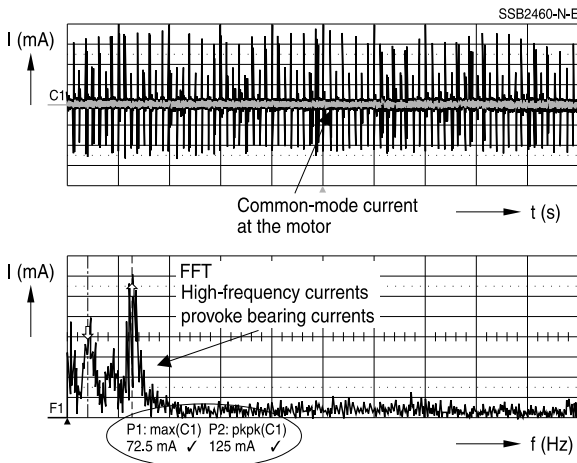

Figure 21
Reduction of bearing currents with a sine-wave filter

Application notes

Figure 22 shows typical values of the bearing currents when using the *SineFormer* EMC sine-wave filter. Compared with Figures 20 and 21, significant improvements can be seen: only the *SineFormer* EMC sine-wave filters can minimize the motor bearing currents. Compare Figure 20.

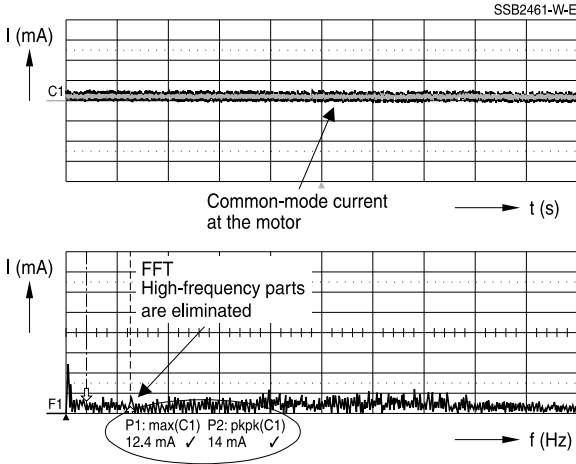

Figure 22
Minimizing bearing currents with the EMC sine-wave filter *SineFormer*

Application notes

5.6 Conclusion

The following conclusions can be drawn:

- The dv/dt chokes reduce the edge steepness of the output voltage (line-to-line). This reduces the probability of motor failure.
- The dv/dt filter reduces the edge steepness of the output voltage (line-to-line) more strongly than the chokes. This also reduces the probability of motor failure.
- The sine-wave filter produces a sinusoidal phase voltage at low extra cost. At the same time, the RF interference voltage with respect to ground is reduced somewhat.
- The EMC sine-wave filter *SineFormer* is the best and at first sight also the most expensive solution, if only the component costs of the various output filter solutions are compared. However, a consideration of system costs (line, filter, motor) shows the unequivocal cost benefits of the *SineFormer* technology: The series of *SineFormer* filters B84143V*R127 has the best price-performance ratio of any output filter and choke solutions!







	Line-to-line voltage	Line-to-ground voltage	Radiated interference	Reduction of motor bearing currents
dv/dt filter			Almost no improvement	None
sine-wave filter			Little improvement	Low
EMC sine-wave filter <i>SineFormer</i>			Almost eliminated	Optimal

Figure 23 Summary of filter properties

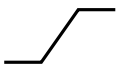
6 Filters for switch-mode power supplies



In electrical technology, switch-mode power supplies are increasingly replacing conventional power supplies based on power transformers and linear controllers. Although the latter may be more cost-effective, they have a large volume and poor efficiency.

In switch-mode power supplies, the input voltage is rectified and smoothed in a DC link circuit. With the aid of semiconductor switches, this DC voltage is then chopped, transformed via a transformer, rectified and smoothed. The switching frequency is usually in the range from approximately 20 kHz to several hundred kHz. The transformers and filter circuits can then be kept very small. As only switching and conducting losses occur, their efficiency is very high compared to linear solutions.

In the first place, a distinction is made between primary and secondary switch-mode converters. The first of these are further subdivided into flyback converters, single-ended forward converters and differential-mode forward converters. The main representatives of the secondary switch-mode converters are the buck and boost converters. All converters have distinct switching modes which are reflected in different voltage and current characteristics during a switching operation.

The advantages resulting from this switching technology in terms of magnitude, efficiency and load regulation are offset by increased EMC problems. The main interference sources are the semiconductor switches, the input and output-side rectifier circuits and not least the drive circuits, often using microcontrollers. The **fundamental interference frequency is the clock frequency** of the converter.

A large part of the losses are produced during the turn-on and turn-off of the semiconductor switches. These briefly traverse a linear state involving both high voltages and high currents. To minimize this time, the semiconductor switches are driven very hard, i.e. they go in about 50 to 100 ns from the blocking to the conducting state.

Application notes

Voltage rise rates dv/dt of several $kV/\mu s$ are then produced. The RF range extends to over 100 MHz.

If the voltage at the rectifier diodes changes from the forward to the reverse direction, the diode current continues to flow briefly due to the carrier storage effect, until it suddenly becomes zero in the barrier layer when the charge carriers have been depleted. This current loss with the simultaneous presence of a reverse voltage generates an interference voltage with fundamental frequencies in the region of several MHz.

Up to several hundred kHz, this mainly takes the form of *differential-mode* interference between the leads. It is attenuated by the stray inductance of the current-compensated chokes in the filter and by X capacitors.

If the differential-mode attenuation in the region below a hundred kHz does not suffice, it can be increased by including suitable powder-core chokes (Figure 24).

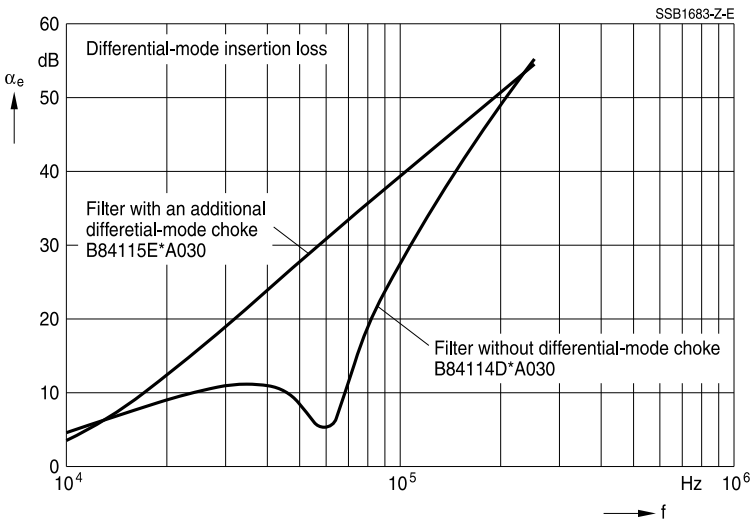
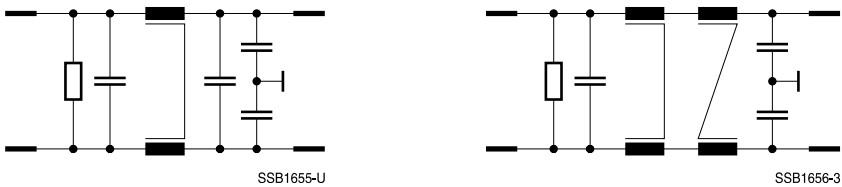

Figure 24 Comparing two filters with and without differential-mode (powder-core) chokes

Application notes

At frequencies from several 100 kHz, as a rule common-mode interference is mainly present. The interference currents flow between the leads and the reference ground. Semiconductors are major interference sources, as their heat-sink mounting gives them a large coupling capacitance with respect to ground and a high dv/dt with respect to the casing.

Current-compensated chokes are used for interference suppression. The active current flowing through their windings compensates the magnetic fluxes in the core. The full inductance affects the common-mode interference. Y capacitors are additionally used to short circuit the interference currents to ground. They are connected mainly to the side of the filter facing the interference source with respect to the reference potential (Figure 25).

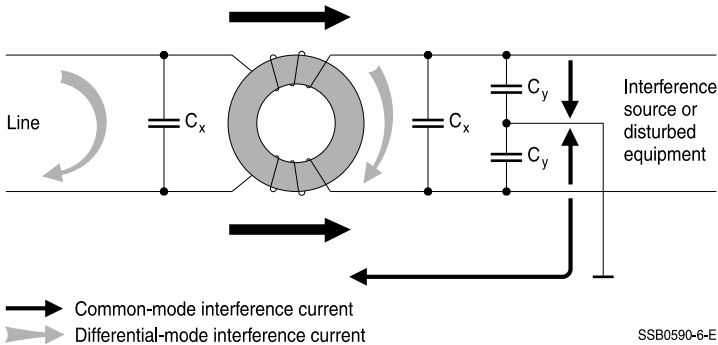

Figure 25 Circuit of a noise suppression filter with a current-compensated choke

As the leakage current of the equipment is limited by the relevant standards (e.g. as a touch current to 0.5 or 3.5 mA) in many applications, the capacitance of the Y capacitors is also limited. The interference suppression effect must then be realized by using correspondingly larger chokes.

At frequencies of several MHz, part of the interference is also transferred via electric and magnetic fields. To obtain a high attenuation, the filter and often also the power supply unit must be shielded, as the RF interference can couple over to the input lead and bypass the filter.

With the SIFI series, EPCOS offers a modular system with a range of attenuations and rated currents. In brief, standardized solutions for almost all applications. (For Data sheets, see the Section on "2-line filters", series B84111A ... B84115E.)

Application notes

To ensure that the filter still operates at high frequencies, it must be connected along a low inductance path to the reference potential. It is not sufficient to connect its ground terminal via a conductor to the reference potential, as the filter will then essentially cease operating at high frequencies (Figure 26). A full-area contact of the filter casing with the reference ground should be aimed at in this case.

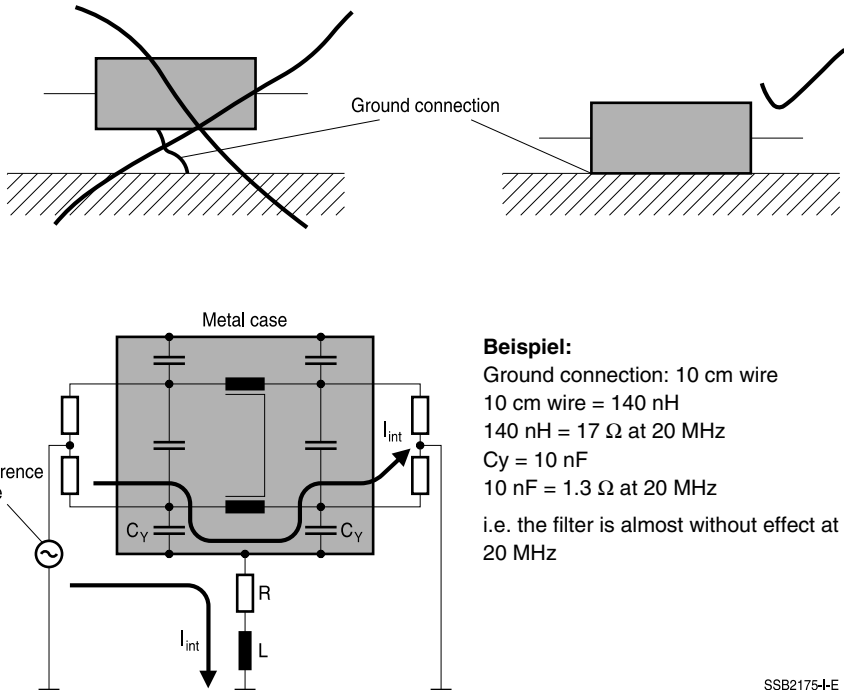

Beispiel:

Ground connection: 10 cm wire

10 cm wire = 140 nH

140 nH = 17 Ω at 20 MHz

$C_Y = 10$ nF

10 nF = 1.3 Ω at 20 MHz

i.e. the filter is almost without effect at 20 MHz

SSB2175-I-E

Figure 26 Effects of incorrect filter mounting

The following points must thus be considered when selecting a filter:

- The overall requirements determine the lower operating frequency of the interference suppression filter.
- The rate of voltage rise dv/dt of the semiconductor switches as well as any fast-switched microcontroller circuits determine the attenuation requirements at high frequencies.
- EMC filters and equipment must be considered as a unit. In many cases, minor circuit modifications (such as re-routing of interconnections or slightly longer turn-on times) are sufficient to allow a smaller and more cost-effective EMC filter to be used.

7 Interference suppression of equipment



All equipment that contains electrical or electronic components is subject to EMC requirements on the basis of EU directives such as the EMC Directive as well as national EMC legislation. The EMC Directive stipulates the observance of protection requirements, which can be derived from harmonized standards.

Where no specific EMC product standard exists for an item of equipment, the respective product family standard applies: it describes the applicable limits as well as test configurations and procedures. Equipment (such as large printing machines, machining centers) which cannot be assigned to any product or product family standard is subject to the basic technical standards (see the tables on pages 32 ff).

Equipment in the sense of the EMC Directive (2004/108/EC) covers apparatus and fixed installations. The former are intended for use by end users and can cause electromagnetic interference or be perturbed by it [Chapter 1, Article 2 1. (b)]. They include sub-assemblies, i.e. functional units intended to be incorporated by end users into equipment, as well as mobile installations consisting of a combination of equipment and possibly other installations designed for operation at various locations [Chapter 1, Article 2 (2)].

Fixed installations consist of several types of apparatus and, where applicable, other devices, which are assembled, installed and intended to be used permanently at a predefined location [Chapter 1, Article 2, 1 (c)].

Application notes

Equipment – apparatus and fixed installations – must observe the fundamental requirements set out in Annex 1 of the EMC Directive

1. Protection requirements

Equipment must be constructed in line with the state of the art so that:

- a) the electromagnetic disturbance originating from it cannot reach a level that prevents the normal operation of radio and telecommunications equipment or other equipment;
- b) it has a level of immunity to the electromagnetic disturbance to be expected in its intended use which allows it to operate without unacceptable degradation of its intended use.

2. Special requirements for fixed installations

Installation and intended use of components:

A fixed installation shall be installed, applying good engineering practices and respecting the information on the intended use of its components, with a view to meeting the protection requirements set out in Point 1. Those good engineering practices shall be documented and the documentation shall be held by the person(s) responsible at the disposal of the relevant national authorities for inspection purposes for as long as the fixed installation is in operation.

Although CE-marking is not binding on permanent installations, their electromagnetic compatibility can in practice only be assured by means of testing.

As a rule, it is not easy to estimate the EMC of large installations, as the apparatus standards were designed only for freely available equipment and include the total electromagnetic environment. There is no generally applicable standard for installations, so that their EMC must be tested and assured in each individual case. If problems occur during operation of the installation, the interference sources must be identified and duly suppressed.

Operators of installations should always urge their suppliers, and these their sub-suppliers, to assure the functional reliability of their equipment by making exclusive use of EMC-compliant equipment and to document this compliance securely by testing.

The specifications given in agreements on the observance of EMC limits have prospective validity for all parties involved. The efforts required to subsequently remedy installations suffering or causing EMC problems are incomparably greater than those required to include EMC components and filters at the planning stage.

To obtain an optimal and cost-effective EMC solution, the installation must be examined by the manufacturer and EMC experts, and appropriate EMC measures (e.g. filters, cable running, maintenance) must be taken. Filters from the Data Book and customer-specific filter solutions are available for this purpose.

Suitable filters for suppressing the interference from individual items of equipment in the installation may be found in the selection tables and application notes in this data book and used accordingly. If necessary, an EMC filter can be adapted to the customer's specifications. The filters must correspond to the respective requirements of the application.